

uvex

2023



protecting people

protecting people – our mission

uvex protects people and the planet

To whom it may concern, dear customers,

Our “protecting people” mission is more relevant than ever! Our commitment to protecting people also includes responsibility with respect to society and the environment, and, as a family business, sustainability has been at the forefront of our thoughts and actions for years.

We have set ourselves ambitious goals in the areas of the environment, the economy and society. In all of our manufacturing facilities, we are working hard to increase energy efficiency and are doing everything we can to become carbon-neutral in the near future. We combine our high quality standards for our products with the development of recycling concepts and the use of bio-based materials. The durability and long service life of our products helps to reduce waste and conserve resources. Under the motto “protecting planet”, we offer a complete product system of environmentally friendly products.

We are already addressing the issues surrounding a future circular economy and will provide innovative solutions which support this initiative in the medium to long term.

We are implementing the concept of sustainability across the board: alongside new, mostly plastic-free packaging, we have also decided that we will no longer print this catalogue, but will instead make it available to you online via our website.

We work continuously to inspire you with innovative products and services that maximise your personal safety in the workplace.

We make every effort to ensure that we are – and will always be – a competent and trustworthy partner when it comes to the safety of your employees and will take responsibility for people and the planet together with you.

The Management Team at UVEX SAFETY GROUP GmbH & Co. KG

Stefan Brück (CEO)

Stefan Wehner

Martin Leusmann



Martin Leusmann



Stefan Brück (CEO)



Stefan Wehner

uvex is the innovative

sustainable brand systems provider

with international manufacturing expertise. We also have a highly qualified cross-national network of strategic partners – including both sourcing as well as sales – that allows us to meet wide-ranging market and customer requirements, offering our entire product and service portfolio. We commit ourselves in the long term to a zero-carbon growth, developing product and service concepts in accordance with the „circular economy“ principle.

Innovation

Always including customer requirements and investing in innovative production and process technologies, we develop, manufacture and distribute industrial and non-industrial safety products that fulfil the highest standards in terms of quality, function and innovation. With our comprehensive service concept, we are pursuing the goals of generating measurable added value for customers around the world. We strive to be the leaders in innovation in our field.

Brand

The uvex brand is our future. It is our primary goal that our customers, suppliers and employees join the uvex brand value experience and generate their own success through the strength of our brand (uvex safety and uvex sports).

Digital transformation

supports our existing core competences, creates additional customer value, facilitates the development of new business models and contributes to securing our existing and future success. Future-oriented methodologies in conjunction with digital tools and processes improve our interface with employees, customers, suppliers and partners.

Quality

As manufacturers, we place extremely high quality demands on our products and services. For us, “made in uvex” is a promise of quality we make to our customers, which they can always count on. Our aim is to effectively balance economical, ecological and social commitment. In order to achieve this, we have set demanding standards for our manufacturing sites and products, which also apply to all partners in our network.

Protecting people

People are at the heart of what we do. Protecting and supporting people in their professional and working environment is our company's goal. We offer our employees opportunities for professional and career development in an international and increasingly digital group of companies.

The winner's podium

is our ultimate target.



protecting planet

**The uvex sustainability label:
a promise for people and the environment**

” We have been protecting people in sports, leisure and at work since 1926. “protecting people” is our mission. “protecting planet” is the natural continuation of this mission when it comes to treating people, society and nature responsibly.

With “protecting planet”, we have created a label that offers maximum transparency and information about our sustainability activities: from resource-saving products and innovative measures in our factories through to social commitment and social projects.

“

Michael Winter, Managing Partner of the uvex group

protecting people is the mission behind all uvex group brands. The aim is to offer people exactly the right protection they need with our own products. However, uvex's definition of "protection" does not just refer to preventing physical injury – it also takes on meaning in a wider social, ecological and economic context. Our pledge to protect society and the environment using the group-wide **protecting planet** concept is therefore derived from our "protecting people" mission.

We live and breathe this philosophy across a wide spectrum of uvex group divisions and have integrated it into all of our processes – after all, this is the only way to credibly convey our pledge for greater sustainability to the outside world. That's why uvex comprehensively tests, evaluates and optimises all steps along the value creation chain to ensure that products are as sustainable as possible.

Examples for the new "protecting planet" label:



At uvex, we are reducing our CO₂ emissions at various levels. For example, the uvex group only uses **green electricity and green gas** in Germany. Our innovative products and services for the global market are produced in our own factories, many of which are located in Germany and Europe. This ensures both **high quality** and **short transport routes**. With regular **sustainability activities** at our production facilities, we in the uvex group are making an important contribution to reducing our environmental footprint.

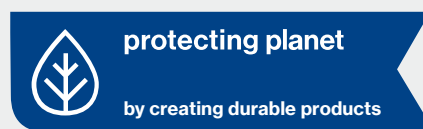

uvex is renowned for offering **products of measurably higher quality** than our competitors. The **innovative eyewear coatings** are one example in this respect. Thanks to their **long durability** and **longer service life**, new products need to be purchased less frequently. This not only saves money in the long term, but also, and perhaps more importantly, conserves valuable resources and produces less waste.



uvex considers plant- and bio-based materials to be the future. That's why materials such as bio-based HDPE (high-density polyethylene) made from sugar cane, Lavalan (pressed wool), Prolan (pressed Bavarian sheep wool), rapeseed-oil-based PU foams, bamboo fibres and bio-based polyamide made of castor oil are already being used in all manner of different products.



Environmentally friendly packaging is part and parcel of the uvex group's **sustainability strategy**. For example, **we use climate-neutral and 100% recyclable packaging**, some of which is even plant-based in the form of grass cardboard. Further examples are grass paper, stone paper, and recycled packaging film and bags made from **renewable raw materials** such as Tencel.

The uvex sustainability label **protecting planet** can be found on products and their packaging, as well as at trade fair stands or in uvex group catalogues, for example. With this approach, we want to not only emphasise uvex's commitment to these areas of sustainability and demonstrate that we have honoured our pledge, but also raise awareness of environmentally friendly and socially responsible business practices and further promote positive development.

uvex profisystem construction

There is a range of challenges which must be faced in the construction industry, with tasks ranging from preparatory site works and civil engineering to building installation and interior fitting. To achieve optimal results, everyone involved must work in flawless synergy with each other – as must all items of personal protective equipment.



uvex has developed and selected over 150 innovative PPE products for the construction industry, all of which are designed to meet the specific needs of the sector. With 12 product categories, the uvex profi system construction provides the perfect solutions for all areas of application, offering the wearer maximum safety, functionality and wearer comfort.



uvex occupational safety shop for professionals

Discover the complete range of PPE and numerous other products that have been specially designed for the construction industry in the uvex occupational safety shop for business customers:

uvex-safety-shop.com



Professional protection for construction professionals

Extreme noise? Dangerous sparks? Hazardous residual contamination? uvex has the right solution for any application – providing professional protection from head to toe. The safety experts at uvex understand the needs of the construction industry and can provide clear advice to help our customers select the right PPE.



All products accompanied by this symbol are ideal for use in the construction industry.

Mobility with safety

With pioneering occupational safety from uvex

The automotive industry is one of the most important economic sectors in Europe. uvex offers high-quality and innovative occupational safety solutions from head to toe: We already protect over one million employees in the automotive industry around the world with our PPE solutions.



Production



Sales and service



The electromobility sector

uvex as a reliable premium partner

- decades of experience in the automotive industry
- cooperation in research and development (future projects/joint developments)
- laboratory support (Chemical Expert System – CES)
- technical on-site support (e.g. workplace inspections)



professional industry solutions

uvex offers industry-specific PPE products and services for the automotive industry.

To find out more about our comprehensive range of products, simply scan the QR code.



Equipped for the mobile future

Safe e-mobility with uvex PPE solutions

The automotive industry is one of the most important economic sectors in Europe. uvex offers high-quality and innovative occupational safety solutions from head to toe: We already protect over one million employees in the automotive industry around the world with our PPE solutions.



Reliable occupational safety with uvex

- comprehensive range of solutions for the high-voltage sector and ESD workplaces
- attractive design with high wearer acceptance of the PPE
- continuous communication with customers for the development of individual PPE solutions



Our experts are at your service

Want to find out more about uvex occupational safety solutions for the automotive industry?

Simply get in touch with our team of experts via the QR code.



#protectingpeopletogether

The coronavirus pandemic and its impact on uvex

Based on recommendations by the Robert Koch Institute, we have developed products to contain the pandemic and have increased the number of existing products in our portfolio:



uvex silv-Air respirators

- protection classes FFP1, FFP2, FFP3
- first-class wearer comfort
- low breathing resistance
- secure supply thanks to upgraded capacity and long-term supply contracts with uvex partners

uvex silv-Air respirators can be found from page 151 onwards.



uvex spectacles with face mask

- designed for hygiene concepts in industry
- set of uvex pheos spectacles and specially developed face mask
- the double-stitched mask can be conveniently used as a storage bag for the safety spectacles



uvex goggles

Recommendation for optimum eye protection against viruses:

- goggles with at least frame marking 3 (liquids/drops/splashes)
- even better with marking 4 (dust, size > 5) and/or 5 (gases and fine dust, size < 5).

uvex goggles can be found from page 58 onwards.



uvex overalls

In the medical and pharmaceutical sectors in particular, employees have to protect their entire body. Therefore, full body protection is extremely important. Many uvex disposable overalls satisfy the requirements of the DIN EN 14126 standard for clothing designed to protect against infectious diseases.

uvex overalls can be found from page 171 onwards.



The uvex hygiene concept

In line with our guiding principle of #protectingpeopletogether, we at uvex have implemented comprehensive in-house safety measures, which enable us to ensure a safe and healthy working environment for employees both at home and on site.

Crisis team

uvex established a crisis team comprising members of all divisions to ensure we can constantly assess the COVID-19 situation based on the most up-to-date expert information.

Digital information

The uvex Intranet provides our internal hygiene concept, informative videos and important health tips. In addition, we have set up a hotline for our employees and their relatives.

Mobile working

uvex has equipped home office workstations with the necessary hardware and has further developed its digital tools accordingly. The option of working from home is to be integrated into the uvex working model as a permanent feature in the future.

Responsible care

Temperature check stations have been installed at all entrances to our sites, and disinfectant is available everywhere. In addition, the frequency of premises cleaning have been increased. And each employee has received a set of disposable and reusable masks.



uvex hygienic protection gloves made in Germany meets Swiss technology

uvex phynomic silv-air and uvex phynomic silv-air grip safety gloves:

- minimise the risk of contact infection from objects within five minutes
- revolutionary textile technology HEIQ VIROBLOCK by CHT inhibits the spread of bacteria and viruses and inactivates up to 99.9% of micro-organisms¹
- increased grip in dry environments due to transparent micro-nubbing on the skin contact points of the uvex phynomic silver-air grip safety gloves



uvex exvi hand sanitiser

- ready-to-use alcohol-free preparation for hygienically sanitising the hands
- very good skin compatibility, dermatologically tested
- can be used in all areas of hygiene; offers good skin compatibility and contains aloe vera
- 100 ml of perfectly portable and skin-compatible hygiene
- only available in Germany



¹ Antiviral effectiveness tested and confirmed at an independent and accredited external laboratory in accordance with ISO 18184

E-procurement with uvex

Faster processing. Lower costs.



We supply electronic catalogues

Static:

- BMEcat 1.2
- BMEcat 2005
- Ariba cif-cat
- Coupa csv-cat
- eCat csv
- Ariba xls-cat

Dynamic:

- OCI
- Punchout levels 1 & 2

Receive all messages via EDI

- Orders
- Order confirmation
- Delivery advice
- Invoice

Via all EDI communication channels

- SMTP
- HTTPS
- HTTP
- FTP
- SFTP
- OFTP
- X.400

In all common EDI message formats

- EDIFACT
- openTRANS
- xCML
- IDOC
- XML
- CSV
- VDA
- xCBL
- ASCII

Digital ordering processes (e-procurement) simplify purchasing processes, save time and reduce costs.

Take advantage of e-procurement with uvex:

- via e-procurement software, e.g. SAP Ariba or Onventis
- via e-marketplaces such as Mercateo and Simple System
- via direct connection of ERP systems such as SAP and Navision
- or simply via the uvex online shop

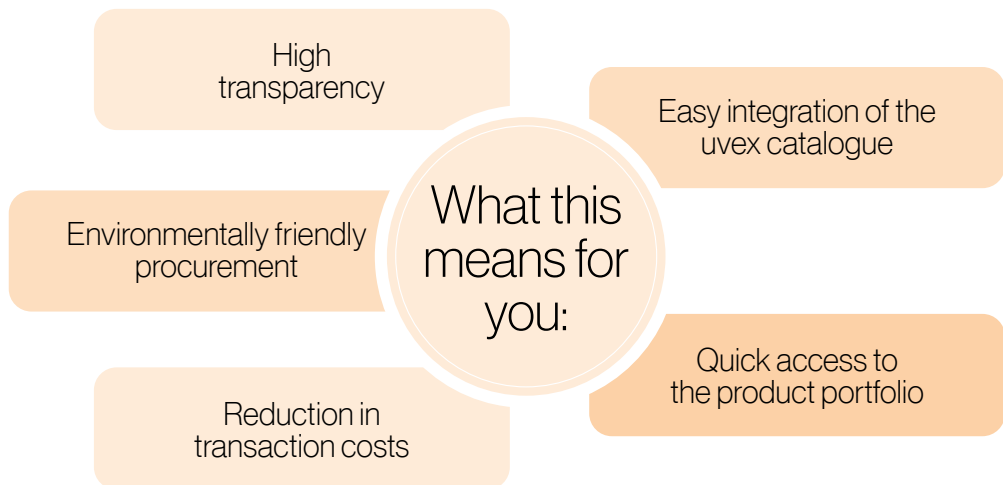

You can find further information at:
uvex-safety.com/e-procurement
 (or by scanning the QR code).



Digital solutions pay off

For your success in e-commerce



uvex offers optimal solutions for your digital sales channels.

Take advantage of our comprehensive electronic services:

- Electronic uvex catalogue
- Electronic data exchange
- Product specifications in seven languages
- Loadbee premium brands content
- Inventory/availability information
- Media database
- Commerce Connector
- uvex dealer locator



You can find further information at:
uvex-safety.com/dealer-service
 (or by scanning the QR code).

Outstanding. In innovation and design.



The uvex brand has an outstanding reputation worldwide and has received countless national and international prizes for first-class performance.

Deutsche Standards named uvex a brand of the century, with its innovative safety eyewear representing an entire category of products in 2016.



As one of the most innovative SMEs in Germany, uvex has also been awarded the **TOP 100 quality seal** on a number of occasions.

uvex pheos cx2 safety spectacles won the **German Innovation Award** in 2018 – this prestigious prize focuses on the people whose future will be positively influenced by the award-winning products.

Prestigious design awards – including the **iF product design award**, the **red dot design award** and the **German Design Award** – confirm that uvex products meet the highest demands for functionality while still looking good.



2020
Quality, design and ease of use:
 uvex i-5
 uvex megasonic

2018
Quality, design and functionality:
 uvex x-fit pro

2017
Quality, design, functionality and ergonomics:
 uvex suXXeed

2016/2017
Innovation, quality, design, functionality and ergonomics:
 uvex 2



Best product 2018:
 uvex x-fit pro

Best product 2017:
 uvex 2

Best workwear brand 2017:
 uvex workwear
 uvex suXXeed



Winner 2020: uvex 1 business

Winner 2019: uvex 1 sport
 uvex suXXeed collection

Nominee 2019: uvex x-fit pro
 uvex x-fit

Winner 2018: uvex pheos cx2
 uvex sportline

Winner 2017: uvex professional metal processing system

Special 2016: uvex 2 VIBRAM (6502, 6503)



Winner 2018: uvex pheos cx2

German Innovation Award 2018



reddot winner 2020



Winner 2022: uvex 3

Winner 2020: uvex i-5
 uvex megasonic
 uvex 1 G2 (6846, 6849)

Winner 2018: uvex 1 sport

Winner 2016: uvex pheos cx2



Winner 2020: uvex 1 G2 (6846, 6849)

Winner 2018: uvex x-fit pro
 uvex x-fit
 uvex 1 sport

Gold 2016: uvex 2 VIBRAM (6502, 6503)

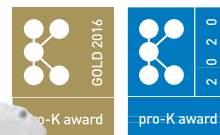

Winner 2020: uvex megasonic

Winner 2018: uvex perffexion

Winner 2017: uvex pheos cx2

Gold 2016: uvex pheos helmet system

uvex



uvex safety + uvex sports. One brand. One mission.



uvex products protect people at work, in sport and for leisure. As a partner of international top-level sport, uvex equips over 1000 professional athletes worldwide, e.g. with ski goggles, equestrian riding helmets and cycling helmets.

The transfer of knowledge between uvex safety and uvex sports makes our products even safer, more functional and more comfortable – both product divisions benefit mutually from the collaboration.

This is evident in our supravision coating technology, for example, which is used equally by both uvex safety and uvex sports. This unique coating ensures maximum anti-fogging properties on sports goggles and safety spectacles, enabling the wearer to put in their very best performance at work or at play.



Safety Eyewear

protecting planet

To help raise awareness of its commitment to achieving increased sustainability, uvex has developed the **protecting planet** icon.

For uvex, **protecting planet** is more than a label. Based on the brand claim, **protecting people**, our sustainable approach integrates three core interlinked pillars – **ecology, economy** and **social responsibility**, that are incorporated throughout the business to improve our sustainability performance.

This explains the comprehensive audit, measurement and evaluation management process uvex undertakes along the entire value chain to ensure its products are as sustainable as possible.



uvex i-range planet

The **uvex i-range planet** is an example of the **planet series** product system.



protecting planet

by using recycled material //
by using bio-based material

The side arms of the spectacles are made from 39 percent bio-based material. uvex uses the castor oil plant as the renewable raw material and the energy used during production is from biomass sources. The couplings and headband hooks are made of 22 percent recycled PET bottles, while the soft face seal is made of more than 35 percent recycled granulate that has been recovered from production waste. The headband of the goggles is made of 72 percent recycled waste yarn.



protecting planet

by using environmentally-
friendly packaging

The films of the polyethylene bags used consist of up to 70 percent recycled material, which is obtained from production waste. All cardboard cartons are made of over 90 percent recycled paper.



protecting planet

by reducing waste

By using a smaller format for our eyewear user instructions has reduced the amount of paper used by 30 percent. Increasing the packaging unit from 5 to 10 pairs of glasses resulted in an additional reduction in the amount of cardboard required and also produces significantly less waste.



Innovative safety eyewear — made in Germany

uvex eye protection centre of expertise

Innovative safety eyewear for the highest quality standards

In Fürth, Bavaria, uvex develops and produces first-class and highly functional safety spectacles, goggles, prescription spectacles and laser protection eyewear. The uvex plant is certified in accordance with ISO 9001:2015 and ISO 50001:2011, and relies on state-of-the-art technology and strategic partnerships to develop future-oriented technologies and products.



uvex safety eyewear greatly exceeds all requirements of the applicable standards.
Because good is not good enough for us.

Perfection as standard from uvex

All safety eyewear is comprehensively tested at the uvex test centre: As well as satisfying national and international safety standards, every item of safety eyewear also meets the exacting uvex standard in terms of functionality, ergonomics, durability and wearer comfort.

Innovative coating technologies are one of uvex's core competencies. The improved uvex supravision excellence universal coating exceeds the anti-fogging requirements of the EN 168 standard four times over.

New uvex product highlights



The innovative highlight:
uvex pure-fit is 100% recyclable thanks to pioneering manufacturing technology.



The responsible highlight:
The materials and versatile safety eyewear concept of the uvex i-range are particularly sustainable.



The sporty highlight:
uvex suXxeed combines sporty design with maximum functionality.

You can find more information about our new products on pages 30/31, 32/33 and 34/35.

Perfect vision for maximum safety

uvex coating expertise

It all comes down to the coating

Looking through lenses that are fogged up, scratched or dirty significantly increases the risk of accidents during the working day. uvex has been synonymous with innovative coating technologies for decades: In our centre of expertise in Fürth, we develop and produce scratch-resistant and anti-fog lenses for a multitude of applications.



The innovative coating technology makes uvex safety eyewear a reliable companion during day-to-day work — in a variety of applications.

Innovative manufacturing process

Conventional safety eyewear combines anti-fogging properties and scratch-resistance on both sides of the lens: This reduces the scratch-resistance and the anti-fogging effect is lessened by regular cleaning. Unlike conventional processes, the unique uvex process applies different coatings to either side of the lens.

Perfect vision whatever the situation

The outside of uvex lenses has an extremely scratch-resistant, chemical-resistant and easy-to-clean coating, while the inside is coated with a highly durable anti-fog effect — for perfect vision and maximum safety. Lenses are also available with an extremely scratch-resistant or anti-fog coating on both sides — depending on the working environment.

uvex supravision excellence — next level performance

uvex has further improved its proven uvex supravision excellence coating technology once again: All lenses now offer twice the performance in terms of anti-fogging time, exceeding the requirements of the EN 168 standard four times over.

dry 0% RH



uvex supravision excellence

Interior	Performance	Exterior
▲▲▲▲	Anti-fog	△△△△
▲▲▲△	Scratch-resistance	▲▲▲▲

- Unique dual-action permanent anti-fog coating on the interior of the lens and a scratch-resistant hard coating on the exterior. This allows each coating to perform at maximum efficiency.
- extremely scratch-resistant and chemical-resistant on the outside of the lens with non-stick, easy to clean technology
- long lasting anti-fog performance on the inside
- anti-fog performance will not diminish even after repeated cleaning
- suitable for a wide range of workplaces

cold -20°C



uvex supravision plus

Interior	Performance	Exterior
▲▲▲▲	Anti-fog	▲▲▲▲
▲▲▲△	Scratch-resistance	▲▲▲△

- long lasting anti-fog performance and scratch-resistance on both sides
- anti-fog performance will not diminish even after repeated cleaning
- suitable for environments where there is high humidity and/or frequent temperature fluctuations



scan for QR-Code for further information.
uvex-safety.com/en/antifog

Find your ideal lens coating

1. Select the **temperature** which best represents your working environment on the **horizontal temperature axis**.
2. Define the **air humidity** of your environment in percentage terms and find the value on the **diagonal axis**.
3. Determine the **level of dirt** on the **vertical axis**.
4. Connect these three points to form a triangle.
5. The part of the triangle with the **largest area** indicates the lens coating most suited for your workplace.



Coating technology

Core Coatings

dirty



uvex supravision sapphire

Interior	Performance	Exterior
△△△△	Anti-fog	△△△△
▲▲▲▲	Scratch-resistance	▲▲▲▲

- extremely scratch-resistant and chemical-resistant on both sides
- non-stick technology making eyewear easier to clean
- for challenging, dirty and/or dusty workplaces

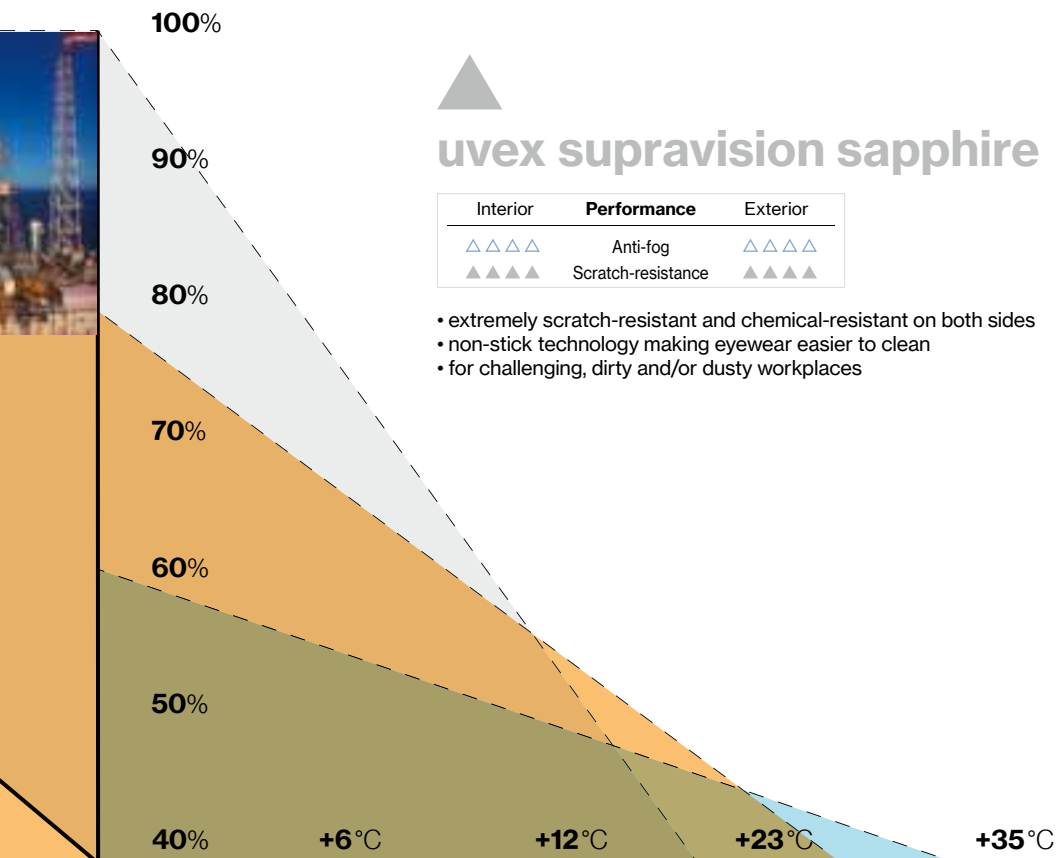

hot +35°C



clean



wet 100% RH

Coating technology

Special Coatings



scan for QR-Code
for further information
uvex-safety.com/en/antifog

uvex supravision extreme

Interior	Performance	Exterior
▲▲▲▲	Anti-fog	△△△△
▲▲▲△	Scratch-resistance	▲▲▲▲

Interior:

- durable, permanent anti-fog performance
- coating forms a thin veil of water without impairing vision

Exterior:

- extremely scratch-resistant, chemical-resistant and easy to clean

Areas of application:

- prolonged exposure to high risk of fogging and dirt

uvex supravision ETC (extreme temperature conditions)

Interior	Performance	Exterior
▲▲▲▲	Anti-fog	▲▲▲▲
▲▲▲△	Scratch-resistance	▲▲▲△

Interior and exterior:

- durable, permanent anti-fog performance
- coating forms a thin veil of water in humid environments without impairing vision

Areas of application:

- workplaces with high humidity and/or frequent temperature fluctuations

uvex supravision clean

Interior	Performance	Exterior
▲▲▲△	Anti-fog	△△△△
▲▲▲△	Scratch-resistance	▲▲▲▲

Specifically developed for the health care sector. Lenses with uvex supravision clean are autoclavable.

Interior:

- lasting anti-fog performance
- anti-fog performance lasts a minimum of 20 autoclave cycles

Exterior:

- extremely scratch-resistant, chemical-resistant and easy to clean

Areas of application:

- dry, clean environments

uvex supravision variomatic

Interior	Performance	Exterior
▲▲▲▲	Anti-fog	△△△△
▲▲▲△	Scratch-resistance	▲▲▲▲

Self-tinting coating that darkens when exposed to UV. Benefits from highly effective anti-fog performance inside, extremely scratch-resistant on the outside.

Self-tinting coating:

- automatically darkens within 10 sec. and lightens within 30 sec.

Areas of application:

- frequent moves between indoor and outdoor environments or light and dark workspaces

uvex supravision infradur

Interior	Performance	Exterior
△△△△	Anti-fog	△△△△
▲▲▲▲	Scratch-resistance	▲▲▲▲

Specifically developed for welding applications. Extremely high scratch-resistance on both sides. Minimises burns from welding sparks.

Areas of application:

- suitable for very dirty, dry welding applications where there is minimal risk of fogging

uvex supravision infradur plus

Interior	Performance	Exterior
▲▲▲▲	Anti-fog	△△△△
▲▲▲△	Scratch-resistance	▲▲▲▲

Specifically developed for welding applications. Lasting anti-fog performance on the inside, extremely scratch-resistant outside and minimises burns from welding sparks.

Areas of application:

- suitable for dirty, welding environments with a high possibility of fogging

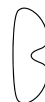

Marking and standards

Marking on lenses in accordance with EN 166

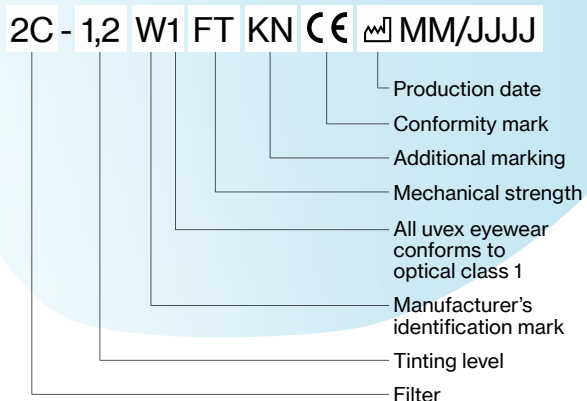

Filter

2	UV protection filter (EN 170)
2C/3	UV protection filter with colour recognition (EN 170)
4	IR protection filter (EN 171)
5	Sunglare filter for industrial use (EN 172)
6	Sunglare filter with infrared requirement

Tinting levels

AR	1.2 (Light transmittance 74.4–100%)
clear	1.2 (Light transmittance 74.4–100%)
amber	1.2 (Light transmittance 74.4–100%)
CBR65	1.4 (Light transmittance 58.1–80%)
silver mirror 53%	1.7 (Light transmittance 43.2–58.1%)
CBR23	2.5 (Light transmittance 17.8–29.1%)
grey 23%	2.5 (Light transmittance 17.8–29.1%)
polavision	3.1 (Light transmittance 8–17.8%)
grey 14%	3.1 (Light transmittance 8–17.8%)
silver mirror 12%	3.1 (Light transmittance 8–17.8%)

Mechanical strength

none	Minimum robustness (filters only)
S	Increased robustness
F	Low-energy impact (45 m/s or 162 km/h)
B	Medium-energy impact (120 m/s or 432 km/h)
A	High-energy impact (190 m/s or 684 km/h)
T	Tested under extreme temperatures (-5°C/+55°C)

Additional markings

K	Surface resistance to damage by small particles in accordance with EN 168 (scratch-resistance)
N	Resistance to fogging in accordance with EN 168
8	Protection against short-circuit electric arc
9	Protection against molten metal and hot solids

Marking on frame in accordance with EN 166

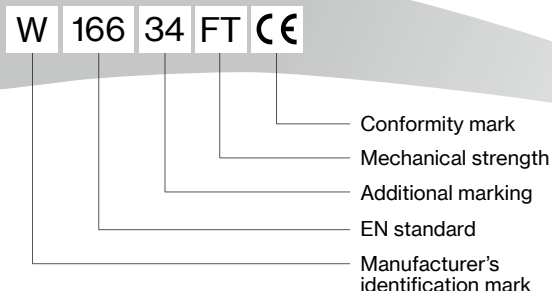

Additional markings

none	General use
3	Protection against liquids (drops and splashes)
4	Protection against large dust particles with a grain size of > 5 µm
5	Protection against gases, vapours, smoke, fumes and fine dust particles with a grain size of < 5 µm
8	Protection against short-circuit electric arc
9	Protection against molten metal and hot solids

Mechanical strength

none	Minimum robustness (filters only)
S	Increased robustness
F	Low-energy impact (45 m/s or 162 km/h)
B	Medium-energy impact (120 m/s or 432 km/h)
A	High-energy impact (190 m/s or 684 km/h)
T	Tested under extreme temperatures (-5°C/+55°C)



Lens tinting

A lens solution for every light environment



CLEAR

Protection: UV400
 UV/markings: 2(C)-1.2
 Transmission: approx. 91 %
 Standards: EN 166, EN 170

Protection against **mechanical hazards** without **glare**



AMBER

Protection: UV400
 UV/markings: 2(C)-1.2
 Transmission: approx. 88 %
 Standards: EN 166, EN 170

Protection against **mechanical hazards** without **glare**, with **contrast enhancement**



CBR65

Protection: UV400
 Marking: 5-1.4
 Transmission: approx. 65 %
 Standards: EN 166, EN 172

Protection **offering relaxing, focused vision**

- ▶ uvex i-5 (p. 37), uvex sportstyle (p. 41), uvex pheos cx2 (p. 42), uvex super f OTG (p. 57), uvex pheos cx2 sonic (p. 60), uvex ultravision (p. 64)



AR (anti-reflective)

Protection: UV400
 UV/markings: 2(C)-1.2
 Transmission: approx. 96.5 %
 Standards: EN 166, EN 170

Optimum **anti-reflective** protection with high degree of light transmission

- ▶ uvex sportstyle (p. 41), uvex i-3/uvex i-3 s (p. 46, 47)

tint with glare protection not necessary ←



74–100 %
 transmission



58–80 %
 transmission

Lens tinting



CBR23

Protection: UV400
 Marking: 5-2.5
 Transmission: approx. 23 %
 Standards: EN 166, EN 172

Protection against **natural glare** with **signal colour recognition** and **increased contrast effect**

► uvex i-5 (p. 37), uvex sportstyle (p. 41), uvex pheos cx2 (p. 42), uvex megasonic (p. 59)



POLAVISION

Protection: UV400
 Marking: 5-3.1
 Transmission: approx. 14 %
 Standards: EN 166, EN 172

Reduction of irritating surface reflection by **filtering scattered light**

► uvex polavision (p. 53)



SILVER MIRROR 53 %

Protection: UV400
 Marking: 5-1.7
 Transmission: approx. 53 %
 Standards: EN 166, EN 172

Protection in **changing light conditions**

► uvex pheos/uvex pheos s (S. 44, 45), uvex i-works (S. 48)



SILVER MIRROR 12 %

Protection: UV400
 Marking: 5-3.1
 Transmission: approx. 12 %
 Standards: EN 166, EN 172

Protection from both highly **artificial light and natural glare conditions**

► uvex sportstyle (p. 41), uvex pheos cx2 (p. 42), uvex i-3 (p. 46)



GREY 23 %

Protection: UV400
 Marking: 5-2.5
 Transmission: approx. 23 %
 Standards: EN 166, EN 172

Protection against **natural glare** with **signal colour recognition**



GREY 12 %

Protection: UV400
 Marking: 5-3.1
 Transmission: approx. 12 %
 Standards: EN 166, EN 172

Protection against **natural glare** with **signal colour recognition**

► uvex pheos cx2 (p. 42)

tint with contrast adjustment recommended

tint with contrast adjustment not necessary

tint with contrast adjustment not necessary

tint with glare protection recommended



uvex UV400

100% UV protection. 100% safety. 100% uvex.

The EN166/170 standard requires safety eyewear to provide UV protection up to 380 nm. The latest scientific findings show that this is not enough. The WHO (World Health Organization) recommends UV protection up to 400 nm.



“The reasons why the WHO recommends UV400 protection are clear. The outer tissues of the eye, cornea and lens fully absorb UV light. While UVB light primarily damages the genetic material, UVA rays penetrate deeper, cause thermal damage and magnify the effects of UVB light.”

Univ.-Prof. Dr. rer. nat. Olaf Strauß



uvex UV400 – included in all uvex safety eyewear

Whether you choose clear or tinted lenses, all uvex safety spectacles are equipped with uvex UV400 effective UV protection as standard – as well as pleasant wearer comfort, a sporty design and top-quality lens coatings.

Even without sun, UV rays can still put strain on the eye

When working outdoors, your eyes are regularly exposed to harmful UV radiation – even when it is cloudy. The result: using insufficient protection risks may cause dangerous long-term damage such as corneal injury, cataracts and blindness.

100 % protection against dangerous UVA and UVB radiation

For the eye and surrounding skin

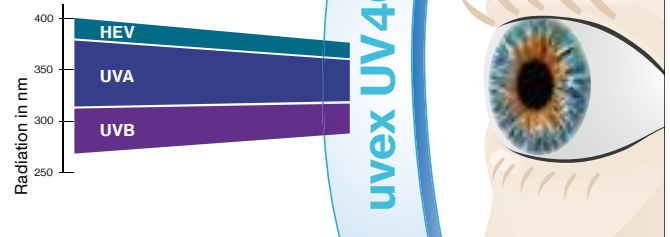

uvex UV400 offers complete protection against UVA and UVB radiation as well as high-energy visible light (HEV) up to a wavelength 400 nm.

uvex UV400 not only filters 100 % of UVA rays (20 % still passes through 380 nm lenses), it also completely minimises temperature-induced cell changes – a factor which increases tenfold in the percentage of total cell damage in the range from 380 to 400 nm. In addition, the dangerous, damaging blue light content (HEV), which is also harmful to the retina, is reduced by 15 %.

uvex safety eyewear,
100 % safety.



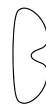

uvex CBR65 and uvex CBR23

Fatigue-free, comfortable vision

Preventive protection against blue light

The properties of the uvex CBR65 and CBR23 lens technology are significantly different to those of uvex UV400. They filter high-energy visible light (HEV) – which causes particular strain on the retina in the range from 380 nm to 450 nm – by up to 50 or 95%.

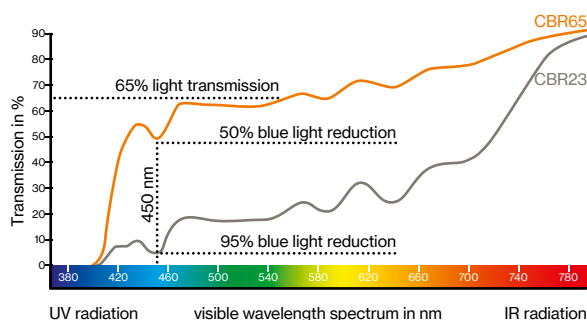

Strain on the eye caused by blue light has increased enormously as a result of intensive use of electronic devices (PCs, smartphones, tablets, LED TVs etc.) and the switch from incandescent light bulbs to LEDs. The short-term effects of this include eye strain, headaches and poor concentration, while in the long term there is an increased risk of age-related macular degeneration. uvex CBR65 and CBR23 reliably protect the eye against health risks without disrupting the body's internal clock.

Contrast

Contrast enhancement

Better contrast for clearer vision, helping to reduce strain on the eyes – even in diffused light.

Bluelight reduction

Blue light reduction

Blue light is reduced by up to 50 or 95%.

Relaxed vision

Relaxed vision

Ideal for high-concentration work; the eyes get less tired even when working for longer periods.

65% transmission

Slight tint

Ideal for use both indoors and outdoors. Ideal for working in bright LED lights, for example.

23% transmission

Optimal protection against glare

Especially for working outdoors.



9183064



9193064



9183223



9193223



9169164



9198064



9198223



9320223



9309064



9301064



For more information, visit uvex-safety.com/en/product-group/uvex-cbr65/

uvex

sustainable. flexible. safe.



uvex i-guard

additional protection against liquids, particles and dirt thanks to the highly flexible frame that adapts to any face shape without pressure (marking 3 and 4 in accordance with EN 166)



uvex i-lite

impressive modern design with flat lens geometry



uvex i-guard+

goggles with headband go above and beyond the minimum requirements and boast increased mechanical strength

uvex i-range



reddot winner 2022

The uvex i-range is our new flexible 3in1 safety eyewear range that allows wearers to select the right product for the workplace hazard or environment.



x-tended sideshield for additional side protection



Flat lens design for an unrestricted field of vision



With proven **uvex supravision coating technology** and UV400 protection



protecting planet

by using recycled material // by using bio-based material

Made of recycled and bio-based materials to conserve resources and protect the environment



Ergonomically shaped side arms for a perfect fit and secure hold without creating pressure points



Three-stage adjustable side arms for individual customisation



Soft and flexible face seal made from sustainable materials for a universal fit



uvex i-guard+ kit can be specifically adjusted to any application thanks to the flexibility to swap the side arms and headband

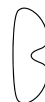

Safety Spectacles

uvex i-range

uvex i-range planet
sustainably manufactured models
made from recycled, bio-based
material



9143295



9143265



9143281



9143296



9143266



9143282



9143297



9143267



9143283

uvex i-range

- versatile 3in1 safety eyewear range – allows eyewear to be adapted according to workplace hazards
- large, flat lens delivers unrestricted field of vision
- x-tended sideshield offers additional protection from hazards
- side arms with multi-incline points allow for a high level of individualisation to ensure a good fit for all facial shapes and head widths
- ergonomically shaped side arms provide a secure fit without pressure
- robust polycarbonate lens with uvex's proven supravision coating technology – permanent anti-fog and scratch-resistant lens

- UV400 – 100 % protection against dangerous UVA and UVB radiation up to 400 nm
- metal-free
- uvex i-guard: soft, flexible face seal adapts to the wearer providing both protection and comfort. It also protects against droplets or splashes of liquids and large dust particles (markings 3 and 4)
- uvex i-guard+: above features together with increased impact protection
- uvex i-guard+ kit: interchangeable side arms and headband means eyewear can be worn as either a spectacle or goggle depending on the workplace hazards



reddot winner 2022



scan the QR code
for further information
uvex-safety.com/en/irange

uvex i-range	uvex i-lite	uvex i-lite planet	uvex i-lite	uvex i-guard	uvex i-guard planet	uvex i-guard
Art. no.	9143265	9143295	9143281	9143266	9143296	9143282
Replacement lens	9143255	9143255	-	9143255	9143255	-
Version	uvex supravision excellence	uvex supravision excellence	uvex supravision excellence	uvex supravision excellence	uvex supravision excellence	uvex supravision excellence
Standard	EN 166, EN 170	EN 166, EN 170	EN 166, EN 172	EN 166, EN 170	EN 166, EN 170	EN 166, EN 172
Frame	anthracite, blue W 166 F CE	anthracite, teal W 166 F CE	anthracite, lime W 166 F CE	anthracite, blue W 166 34 F CE	anthracite, teal W 166 34 F CE	anthracite, lime W 166 34 F CE
Lens	PC clear UV400 2C-1,2 W1 FKN CE	PC clear UV400 2C-1,2 W1 FKN CE	PC grey 23% UV400 5-2,5 W1 FKN CE	PC clear UV400 2C-1,2 W1 FKN CE	PC clear UV400 2C-1,2 W1 FKN CE	PC grey 23% UV400 5-2,5 W1 FKN CE
Weight	32 g	32 g	32 g	48 g	48 g	48 g
Order quantity multiples	10 PC	10 PC	10 PC	8 PC	8 PC	8 PC

uvex i-range	uvex i-guard+	uvex i-guard+ planet	uvex i-guard+	uvex i-guard+ kit
Art. no.	9143267	9143297	9143283	9143300
Replacement lens	9143255	9143255	-	9143255
Version	uvex supravision excellence	uvex supravision excellence	uvex supravision excellence	uvex supravision excellence
Standard	EN 166, EN 170	EN 166, EN 170	EN 166, EN 172	EN 166, EN 170
Frame	anthracite, blue W 166 34 B CE	anthracite, teal W 166 34 B CE	anthracite, lime W 166 34 B CE	anthracite, blue W 166 34 B CE
Lens	PC clear UV400 2C-1,2 W1 BKN CE	PC clear UV400 2C-1,2 W1 BKN CE	PC grey 23% UV400 5-2,5 W1 BKN CE	PC clear UV400 2C-1,2 W1 BKN CE
Weight	50 g	50 g	50 g	56 g
Order quantity multiples	8 PC	8 PC	8 PC	8 PC

**You can find more information
about the sustainable i-range
models on pages 18/19.**

MADE IN GERMANY

uvex

stylish. safe. sustainable.

Designed to recycle

Thanks to an innovative new production technology, the uvex pure-fit can be manufactured fully automatically from just one material without the need for additional assembly.

It is made entirely of polycarbonate and is therefore 100% recyclable – just like the product packaging.

This makes the uvex pure-fit an extremely sustainable solution.

Not just innovative but comfortable too:

These safety spectacles are extremely lightweight. The flexible side arms fit perfectly to any head shape and ensure a secure hold.

The uvex pure-fit is available in two different versions: uncoated and, of course, coated with the proven uvex supravision coating technology.



uvex pure-fit



Frameless and innovative lens design for an optimum, unrestricted field of vision



Flexible side arms for a perfect fit and secure hold without creating pressure points

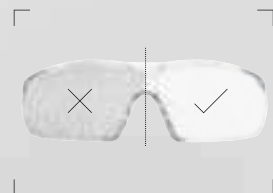

With proven uvex supravision coating technology or uncoated – but always with UV400 protection

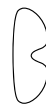

Safety Spectacles

uvex pure-fit



scan for QR-Code
for further information.
uvex-safety.com/en/purefit

x-tended sideshield
for additional side protection



reduced to the max – pure, ultra-light-weight safety eyewear made of polycarbonate, weighing only 19 grams



100% recyclable



9145014



9145265

uvex pure-fit



- reduced to the max - pure, ultralight safety spectacle with innovative side arm concept weighing only 19 grams
- frameless lens design for a wide field of vision
- x-tended sideshield offers additional protection from hazards
- flexible side arms deliver the perfect secure, pressure-free fit
- nose bridge designed for all-day comfort
- robust polycarbonate lens with uvex's proven supravision coating technology – permanent anti-fog and scratch-resistant lens
- UV400 – 100 % protection against dangerous UVA and UVB radiation up to 400 nm
- metal-free

uvex pure-fit		
Art. no.	9145014	9145265
Version	uncoated	uvex supravision excellence
Standard	EN 166, EN 170	EN 166, EN 170
Frame	transparent W 166 FT CE	transparent W 166 FT CE
Lens	PC clear UV400 2C-1,2 W1 FT CE	PC clear UV400 2C-1,2 W1 FTKN CE
Weight	19 g	19 g
Order quantity multiples	75 PC	75 PC



protecting planet

by creating
recyclable products

MADE IN GERMANY

uvex

strong.
sporty.
functional.

eXXtremely cool look
dynamic, attractive
frame design

maXXimum comfort
ergonomically shaped side arms
with soft-grip temple ends for a
comfortable and secure hold

fleXXible nose pad
for a non-slip and
pressure-free fit

eXXcellent vision
with proven uvex supravision
coating technology and UV400
protection



uvex suXXeed

eXXtra protection
against particles, dirt and
dust is provided by the
optional clip-in frame





Safety Spectacles

uvex suXXeed

uvex suXXeed protects you all day at work and in almost any situation.

The dynamic look, the perfect-fit frame geometry and the comfortable side arms leave nothing to be desired – wearer acceptance, comfort and protection are guaranteed.

Even during intense physical activity and when performing strenuous work, uvex suXXeed stays where it should be: in front of your eyes, for your protection. The soft, flexible nose pad provides a comfortable, non-slip grip.

If you need even more protection from dust and dirt, you can simply upgrade the uvex suXXeed with an optional clip-in frame.



9181265



9181180



9181281



Accessories: 9181001
Clip-in frame for uvex suXXeed



scan for QR-Code for further information
uvex-safety.com/en/suxxneed-eyewear

uvex suXXeed

- sporty safety spectacle in an appealing, dynamic design
- ergonomically shaped side arms with soft-grip temple ends provide a comfortable, secure fit without pressure
- soft, flexible nose pad adapts to the wearer, delivering a non-slip and pressure-free fit
- UV400 – 100 % protection against dangerous UVA and UVB radiation up to 400 nm

- robust polycarbonate lens with uvex's proven supravision coating technology – permanent anti-fog and scratch-resistant lens
- optional clip-in frame seal provides extra protection against particles, dirt and dust
- metal-free



uvex suXXeed	uvex suXXeed guard	uvex suXXeed	clip-in frame
Art. no. 9181265	9181180	9181281	9181001
Version uvex supravision excellence	uvex supravision excellence	uvex supravision excellence	clip-in frame for uvex suXXeed
Standard EN 166, EN 170	incl. clip-in frame	sunglare filter	
Frame anthracite, blue	EN 166, EN 170	EN 166, EN 172	black
W 166 FT CE	anthracite, blue	anthracite, lime	
Lens PC clear	W 166 FT CE	W 166 FT CE	
UV400	PC clear	PC grey 23%	
2C-1,2 W1 FTKN CE	UV400	UV400	
Weight 27 g	2C-1,2 W1 FTKN CE	5-2,5 W1 FTKN CE	5 g
Order quantity multiples 10 PC	32 g	27 g	20 PC
	10 PC	10 PC	

MADE IN GERMANY

uvex

uvex i-5

detailed – modern – trusted

Reliable protection thanks to the innovative and modern design: with its x-tended eyeshield and sideshield, the uvex i-5 can be relied on to protect the eyes in any situation.

Sophisticated features ensure superior wearer comfort even during long periods of use.



reddot winner 2020



Three-stage inclination
allows easy adjustment
to any facial shape

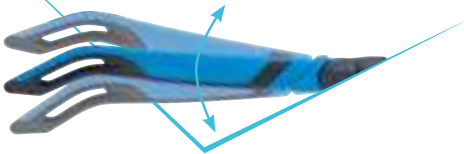

x-tended sideshield
provides optimum protection
around the sides of the eyes



x-tended eyeshield
provides greater protection
against particles, dust and dirt



x-twist technology
for flexible and comfortable
adjustment to any head shape



uvex supervision
coating technology

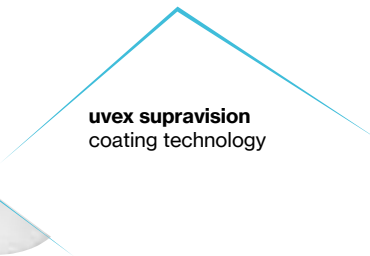

**Soft and flexible
nose pad**
for pressure-free wearer
comfort and a non-slip fit



MADE IN GERMANY



Safety Spectacles

uvex i-5 · uvex i-5 guard



9183065
9183415
9183265



9183180



9183064



9183223



9183281



Further information can be found at
uvex-safety.com/en/i5
(or scan the QR code).



Accessories: 9183001
Clip-in frame for uvex i-5

uvex i-5

- sporty premium quality safety spectacle with a range of adaptive features
- x-tended eyeshield: soft seal frame technology wraps around the brow providing protection from particle ingress
- x-tended sideshield offers additional protection from hazards
- ergonomically shaped side arms with multi-incline points and length adjustment allow for a high level of individualisation to ensure a good fit for all facial shapes and head widths
- soft-grip temple ends provide a comfortable, secure fit without pressure

- soft, flexible nose pad adapts to the wearer, delivering a non-slip and pressure-free fit
- robust polycarbonate lens with uvex's proven supravision coating technology – permanent anti-fog and scratch-resistant lens
- UV400 – 100 % protection against dangerous UVA and UVB radiation up to 400 nm
- optional clip-in frame seal provides extra protection against particles, dirt and dust
- metal-free



reddot winner 2020



uvex i-5	9183065	9183265	9183415	uvex i-5 guard
Art. no.	9183065	9183265	9183415	9183180
Version	uvex supravision sapphire	uvex supravision excellence	uvex supravision ETC	uvex supravision excellence incl. clip-in frame
Standard Frame	EN 166, EN 170 anthracite, blue W 166 FT CE	EN 166, EN 170 anthracite, blue W 166 FT CE	EN 166, EN 170 anthracite, blue W 166 FT CE	EN 166, EN 170 anthracite, blue W 166 FT CE
Lens	PC clear UV400 2C-1,2 W1 FTK CE	PC clear UV400 2C-1,2 W1 FTKN CE	PC clear UV400 2C-1,2 W1 FTKN CE	PC clear UV400 2C-1,2 W1 FTKN CE
Weight	29 g	29 g	29 g	35 g
Order quantity multiples	10 PC	10 PC	10 PC	10 PC

uvex i-5	9183064	9183223	9183281	clip-in frame
Art. no.	9183064	9183223	9183281	9183001
Version	uvex supravision excellence sunglare filter	uvex supravision excellence sunglare filter	uvex supravision excellence sunglare filter	clip-in frame for uvex i-5
Standard Frame	EN 166, EN 172 white, black W 166 FT CE	EN 166, EN 172 white, black W 166 FT CE	EN 166, EN 172 anthracite, lime W 166 FT CE	anthracite
Lens	PC CBR65 UV400 5-1,4 W1 FTKN CE	PC CBR23 UV400 5-2,5 W1 FTKN CE	PC grey 23% UV400 5-2,5 W1 FTKN CE	
Weight	29 g	29 g	29 g	6 g
Order quantity multiples	10 PC	10 PC	10 PC	20 PC

MADE IN GERMANY

Safety Spectacles

uvex x-fit pro · uvex x-fit pro guard



9199005



9199247



9199245



9199680



9199277



9199276

uvex x-fit pro

- functional, modular safety spectacle with a wide range of accessories
- ergonomically shaped side arms with soft-grip temple ends provide a comfortable, secure fit without pressure
- adjustment for every head and facial shape with the uvex Comfort Slider - a multi-stage temple inclination that allows wearers to achieve their own comfortable wearing position
- modular system allows functional accessories to be attached enhancing the ability to get on with the job

- soft, flexible nose pad adapts to the wearer, delivering a non-slip and pressure-free fit
- robust polycarbonate lens with uvex's proven supravision coating technology – permanent anti-fog and scratch-resistant lens
- UV400 – 100 % protection against dangerous UVA and UVB radiation up to 400 nm
- optional clip-in frame seal provides extra protection against particles, dirt and dust
- metal-free



uvex x-fit pro	9199005	9199247	9199245	uvex x-fit pro guard
Art. no.	9199005	9199247	9199245	9199680
Version	uvex supravision sapphire	uvex supravision excellence without sliders	uvex supravision excellence	uvex supravision excellence without sliders, incl. clip-in frame
Standard Frame	EN 166, EN 170 white, anthracite W 166 FT CE	EN 166, EN 170 blue, anthracite W 166 FT CE	EN 166, EN 170 blue, anthracite W 166 FT CE	EN 166, EN 170 blue, anthracite W 166 FT CE
Lens	PC clear UV400 2C-1,2 W1 FTK CE	PC clear UV400 2C-1,2 W1 FTKN CE	PC clear UV400 2C-1,2 W1 FTKN CE	PC clear UV400 2C-1,2 W1 FTKN CE
Weight	28 g	24 g	28 g	30 g
Order quantity multiples	10 PC	10 PC	10 PC	10 PC

uvex x-fit pro	9199277	9199276
Art. no.	9199277	9199276
Version	uvex supravision excellence sunglare filter, without sliders	uvex supravision excellence sunglare filter
Standard Frame	EN 166, EN 172 anthracite, light grey W 166 FT CE	EN 166, EN 172 anthracite, light grey W 166 FT CE
Lens	PC grey 23% UV400 5-2,5 W1 FTKN CE	PC grey 23% UV400 5-2,5 W1 FTKN CE
Weight	24 g	28 g
Order quantity multiples	10 PC	10 PC

MADE IN GERMANY



Safety Spectacles

uvex x-fit · uvex x-fit guard



uvex x-fit

- classic, close fitting safety spectacle with extension kit options
- frameless lens design for a wide field of vision
- adjustment for every head and facial shape with the optional uvex Comfort Slider - a multi-stage temple inclination that allows wearers to achieve their own comfortable wearing position
- modular system allows functional accessories to be attached enhancing the ability to get on with the job
- nose bridge designed for all-day comfort

- robust polycarbonate lens with uvex's proven supravision coating technology – permanent anti-fog and scratch-resistant lens
- UV400 – 100 % protection against dangerous UVA and UVB radiation up to 400 nm
- optional clip-in frame seal provides extra protection against particles, dirt and dust
- metal-free



uvex x-fit						uvex x-fit guard		
Art. no.	9199085	9199285	9199265	9199123	9199415	9199180	9199286	9199280
Version	uvex supravision sapphire	uvex supravision excellence	uvex supravision excellence	uvex supravision excellence	uvex supravision ETC	uvex supravision excellence	uvex supravision excellence	uvex supravision excellence
Standard Frame	EN 166, EN 170 grey translucent W 166 FT CE	EN 166, EN 170 grey translucent W 166 FT CE	EN 166, EN 170 blue translucent W 166 FT CE	EN 166, EN 170 pink translucent W 166 FT CE	EN 166, EN 170 blue translucent W 166 FT CE	EN 166, EN 170 grey translucent W 166 FT CE	EN 166, EN 170 grey translucent W 166 FT CE	EN 166, EN 172 grey translucent W 166 FT CE
Lens	PC clear UV400 2C-1.2 W1 FTK CE	PC clear UV400 2C-1.2 W1 FTKN CE	PC clear UV400 2C-1.2 W1 FTKN CE	PC clear UV400 2C-1,2 W1 FTKN CE	PC clear UV400 2C-1.2 W1 FTKN CE	PC clear UV400 2C-1,2 W1 FTKN CE	PC amber UV400 2C-1.2 W1 FTKN CE	PC grey 23% UV400 5-2.5 W1 FTKN CE
Weight	23 g	23 g	23 g	23 g	23 g	29 g	23 g	23 g
Order quantity multiples	10 PC	10 PC	10 PC	10 PC	10 PC	10 PC	10 PC	10 PC

Art. no.	uvex Comfort Slider 9958024	clip-in frame 9199001	uvex x-fit pro Headband 9958023	uvex mini LED light 9999100
Version	for attaching to uvex x-fit and uvex x-fit pro side arms	clip-in frame for uvex x-fit and uvex x-fit pro	for attaching on uvex x-fit and uvex x-fit pro, metal-free	incl. 2 adapters (left and right) 4 button cell batteries type L736F Adapter+ housing: black Light: white
Colour	anthracite	black	black	
Order unit/ Order quantity multiples	BG 5 Pair	20 PC	10 PC	PC
Content				

MADE IN GERMANY

uvex safety eyewear

Also ideal for narrow faces

The geometries of our spectacles are as different as the faces of the people who wear them. The products in this range can be worn by anyone, but are particularly suitable for people with narrow faces.

Their optimal fit and the fact that they can be adjusted mean that these safety spectacles fit different head shapes perfectly, providing the wearer with the best possible protection from particles, sparks or dust.

uvex has a range of safety eyewear
to meet every need —
including those
with narrower faces.

uvex spectacles:



uvex x-fit 9199



uvex sportstyle 9193



uvex pheos cx2 9198



uvex pheos s 9192



uvex i-3 s 9190



uvex i-works 9194

uvex goggles:



uvex i-guard+ 9143



uvex pheos s guard 9192



uvex pheos cx2 sonic 9309



uvex carbonvision 9307





Safety Spectacles

uvex sportstyle



uvex sportstyle

- sporty, lightweight safety spectacle with a contoured lens that will fit narrow and wider faces equally well
- the combination of soft padding around the brow with ergonomically shaped side arms and soft-grip temple ends provide a comfortable, secure fit without pressure
- soft, adjustable nose pad allows spectacle to be adapted to the wearer to deliver a comfortable, non-slip and pressure-free fit
- robust polycarbonate lens with uvex's proven supravision coating technology – permanent anti-fog and scratch-resistant lens
- UV400 – 100 % protection against dangerous UVA and UVB radiation up to 400 nm

uvex sportstyle					
Art. no.	9193080	9193265	9193415	9193376	9193838
Version	uvex supravision plus oil & gas	uvex supravision excellence	uvex supravision ETC	uvex supravision extreme	uvex supravision AR super anti-reflective lenses
Standard	EN 166, EN 170	EN 166, EN 170	EN 166, EN 170	EN 166, EN 170	EN 166, EN 170
Frame	black, grey W 166 FT CE	black, lime W 166 FT CE	anthracite, blue W 166 FT CE	black, petrol W 166 FT CE	black, blue W 166 FT CE
Lens	PC clear UV400 2C-1.2 W1 FTKN CE	PC clear UV400 2C-1.2 W1 FTKN CE	PC clear UV400 2C-1.2 W1 FTKN CE	PC clear UV400 2C-1.2 W1 FTKN CE	PC clear UV400 2C-1.2 W1 FT CE
Weight	23 g	23 g	23 g	23 g	23 g
Order quantity multiples	10 PC	10 PC	10 PC	10 PC	10 PC

uvex sportstyle					
Art. no.	9193064	9193223	9193280	9193885	9193880
Version	uvex supravision extreme sunglare filter	uvex supravision extreme sunglare filter	uvex supravision extreme sunglare filter	anti-fog on the inside sunglare filter, silver mirror	uvex supravision variomatic self-tinting lenses
Standard	EN 166, EN 172	EN 166, EN 172	EN 166, EN 172	EN 166, EN 172	EN 166, EN 170
Frame	white, black W 166 FT CE	white, black W 166 FT CE	white, black W 166 FT CE	black, grey W 166 FT CE	black, anthracite W 166 FT CE
Lens	PC CBR65 UV400 5-1.4 W1 FTKN CE	PC CBR23 UV400 5-2.5 W1 FTKN CE	PC grey 23% UV400 5-2.5 W1 FTKN CE	PC silver mirror, grey UV400 5-3.1 W1 FTN CE	PC light green UV400 2-1.2 W1 FTKN CE
Weight	23 g	23 g	23 g	23 g	23 g
Order quantity multiples/ Order unit	10 PC	10 PC	10 PC	10 PC	PC

MADE IN GERMANY

Safety Spectacles

uvex pheos cx2



► Also available as wide-vision goggles (see page 60)

uvex pheos cx2

- sporty looking safety spectacle with high wearer acceptance
- x-tended eyeshield: soft seal frame technology wraps around the brow providing protection from particle ingress
- ergonomically shaped side arms with soft-grip temple ends provide a comfortable, secure fit without pressure
- soft, flexible nose pad adapts to the wearer, delivering a non-slip and pressure-free fit
- robust polycarbonate lens with uvex's proven supravision coating technology – permanent anti-fog and scratch-resistant lens



GERMAN INNOVATION AWARD 2018



GERMAN DESIGN AWARD WINNER 2018

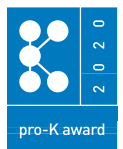

- UV400 – 100 % protection against dangerous UVA and UVB radiation up to 400 nm
- metal-free

uvex pheos cx2						
Art. no.	9198275	9198257	9198258	9198256	9198415	9198261
Version	uvex supravision sapphire	uvex supravision excellence	uvex supravision excellence	uvex supravision excellence	uvex supravision ETC	uvex supravision extreme
Standard	EN 166, EN 170	EN 166, EN 170	EN 166, EN 170	EN 166, EN 170	EN 166, EN 170	EN 166, EN 170
Frame	blue, grey W 166 FT CE	blue, grey W 166 FT CE	red, grey W 166 FT CE	black, light blue W 166 FT CE	anthracite, blue W 166 FT CE	black, light blue W 166 FT CE
Lens	PC clear UV400 2C-1.2 W1 FTK CE	PC clear UV400 2C-1.2 W1 FTKN CE	PC clear UV400 2C-1.2 W1 FTKN CE	PC clear UV400 2C-1.2 W1 FTKN CE	PC clear UV400 2C-1.2 W1 FTKN CE	PC clear UV400 2C-1.2 W1 FTKN CE
Weight	28 g	28 g	28 g	28 g	28 g	28 g
Order quantity multiples	10 PC	10 PC	10 PC	10 PC	10 PC	10 PC

uvex pheos cx2						
Art. no.	9198285	9198064	9198223	9198237	9198230	9198885
Version	uvex supravision excellence contrast-enhancing	uvex supravision excellence sunglare filter	uvex supravision excellence sunglare filter	uvex supravision excellence sunglare filter	uvex supravision excellence sunglare filter	anti-fog on the inside sunglare filter, silver mirror
Standard	EN 166, EN 170	EN 166, EN 172	EN 166, EN 172	EN 166, EN 172	EN 166, EN 172	EN 166, EN 172
Frame	black, yellow W 166 FT CE	white, black W 166 FT CE	white, black W 166 FT CE	white, black W 166 FT CE	weiß, schwarz W 166 FT CE	blue, grey W 166 FT CE
Lens	PC amber UV400 2C-1.2 W 1 FTKN CE	PC CBR65 UV400 5-1.4 W 1 FTKN CE	PC CBR23 UV400 5-2.5 W1 FTKN CE	PC grey 23% UV400 5-2.5 W 1 FTKN CE	PC grey 12% UV400 5-3,1 W1 FTKN CE	PC silver mirror, grey UV400 5-3,1 W1 FTKN CE
Weight	28 g	28 g	28 g	28 g	28 g	28 g
Order quantity multiples	10 PC	10 PC	10 PC	10 PC	10 PC	10 PC

MADE IN GERMANY

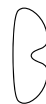

Safety eyewear – matching your corporate identity

Eye protection with “personality”

Give your team an unmistakable image: uvex safety eyewear offer various options for individual design – from printing your company’s logo on the side arms to frames in your company’s colours. You can coordinate your protective equipment perfectly with your corporate identity.

Frames in the company colours

“Your” safety spectacles are recognisable at first glance: the frames are designed in your company colours.



Insert in the side arms

Adding your company name to the soft components of the side arms is both bespoke and subtle.

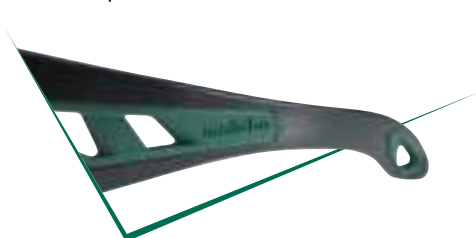

Pad printing on the side arms (1 to 4 colours)

The direct pad printing process is recommended for printing your logo in colour on the side arms.

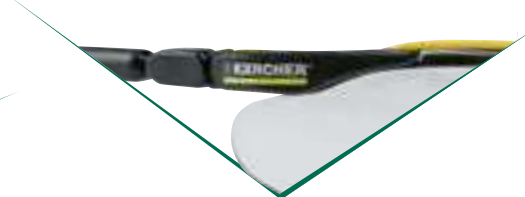

How individual can you be?

We are happy to advise you personally on the technical options for customising our safety eyewear.

Please note that the following minimum quantities must be ordered:

Pad printing – minimum of 500 pairs

A combination of either lens and/or frame, with and without pad printing - minimum of 2,500 pairs.

Insert/customised corporate colouring/individual headband/

laser engraving – minimum of 5,000 pairs

Customised accessories available on request

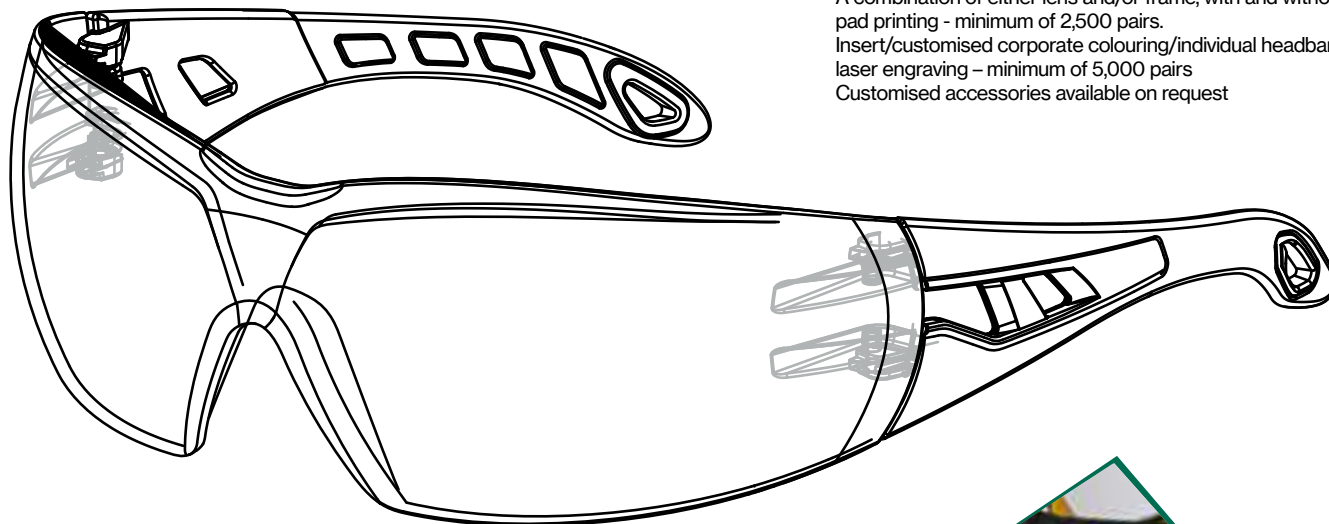

Customised accessories

Have your logo printed on your spectacle case.



Laser engraving on the lens

Safety spectacles will retain 100% of their functionality even with customised laser engraving.



Headband embroidery

Customise your goggles by having your corporate logo embroidered on the headband.



Safety Spectacles

uvex pheos · uvex pheos guard



uvex pheos

- sporty, timeless safety spectacle; frameless design allowing for an extra-large field of vision
- ergonomically shaped side arms with soft-grip temple ends provide a comfortable, secure fit without pressure
- nose bridge designed for all-day comfort
- robust polycarbonate lens with uvex's proven supravision coating technology – permanent anti-fog and scratch-resistant lens

- UV400 – 100 % protection against dangerous UVA and UVB radiation up to 400 nm
- optional clip-in frame seal provides extra protection against particles, dirt and dust
- headband option holds eyewear in place during overhead or work in confined spaces
- available as standard size or narrow version
- fits the uvex IES
- metal-free

uvex pheos				uvex pheos CB		
Art. no.	9192080	9192225	9192215	9192485	9192415	9192280
Version	uvex supravision plus standard size, oil & gas	uvex supravision excellence standard size	uvex supravision excellence standard size	uvex supravision excellence standard size	uvex supravision ETC standard size	uvex supravision extreme standard size
Standard	EN 166, EN 170	EN 166, EN 170	EN 166, EN 170	EN 166, EN 170	EN 166, EN 170	EN 166, EN 170
Frame	black, grey W 166 FT CE	black, green W 166 FT CE	light grey, grey W 166 FT CE	black, grey W 166 FT CE	anthrazit, blau W 166 FT CE	black, grey W 166 FT CE
Lens	PC clear UV400 2C-1.2 W1 FTKN CE	PC clear UV400 2C-1.2 W1 FTKN CE	PC clear UV400 2C-1.2 W1 FTKN CE	PC clear UV400 2C-1.2 W1 FTKN CE	PC farblos UV400 2C-1,2 W1 FTKN CE	PC clear UV400 2C-1.2 W1 FTKN CE
Weight	29 g	29 g	29 g	30 g	29 g	29 g
Order quantity multiples	10 PC	10 PC	10 PC	10 PC	10 PC	10 PC

uvex pheos					uvex pheos guard
Art. no.	9192385	9192285	9192281	9192881	9192180
Version	uvex supravision excellence standard size, contrast-enhancing	uvex supravision excellence standard size, sunglare filter	uvex supravision extreme standard size, sunglare filter	anti-fog on the inside standard size, sunglare filter, silver mirror	uvex supravision extreme standard size incl. clip-in frame and headband
Standard	EN 166, EN 170	EN 166, EN 172	EN 166, EN 172	EN 166, EN 172	EN 166, EN 170
Frame	black, yellow W 166 FT CE	black, grey W 166 FT CE	black, grey W 166 FT CE	light grey, grey W 166 FT CE	black, grey W 166 FT CE
Lens	PC amber UV400 2C-1.2 W1 FTKN CE	PC grey 23% UV400 5-2.5 W1 FTKN CE	PC grey 23% UV400 5-2.5 W1 FTKN CE	PC silver mirror grey UV400 5-1.7 W1 FTN CE	PC clear UV400 2C-1.2 W1 FTKN CE
Weight	29 g	29 g	29 g	29 g	46 g
Order quantity multiples	10 PC	10 PC	10 PC	10 PC	10 PC

MADE IN GERMANY

Safety Spectacles

uvex pheos s · uvex pheos s guard



9192725



9192785



9192282



9192745



9192283



9192891



9192680

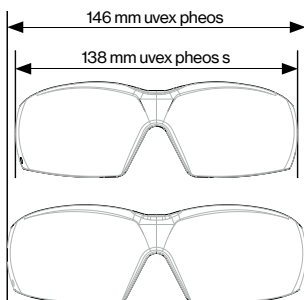

Accessories: 9192001 / 9192002
Clip-in frame uvex pheos / uvex pheos s



Accessories: 9958020
Headband uvex pheos / uvex pheos s

	uvex pheos s						uvex pheos s guard
Art. no.	9192725	9192785	9192282	9192745	9192283	9192891	9192680
Version	uvex supervision excellence narrow version	uvex supervision excellence narrow version	uvex supervision extreme narrow version	uvex supervision excellence narrow version, sunglare filter	uvex supervision extreme narrow version, sunglare filter	uvex supervision anti-fog on the inside narrow version, sunglare filter	uvex supervision extreme narrow version incl. clip-in frame and headband
Standard Frame	EN 166, EN 170 white, green W 166 FT CE	EN 166, EN 170 anthracite, grey W 166 FT CE	EN 166, EN 170 black, grey W 166 FT CE	EN 166, EN 172 white, orange W 166 FT CE	EN 166, EN 172 black, grey W 166 FT CE	EN 166, EN 172 light grey, grey W 166 FT CE	EN 166, EN 170 black, grey W 166 FT CE
Lens	PC clear UV400 2C-1.2 W1 FTKN CE	PC clear UV400 2C-1.2 W1 FTKN CE	PC clear UV400 2C-1.2 W1 FTKN CE	PC grey 23% UV400 5-2.5 W1 FTKN CE	PC grey 23% UV400 5-2.5 W1 FTKN CE	PC silver mirror grey UV400 5-1.7 W1 FTN CE	PC clear UV400 2C-1.2 W1 FTKN CE
Weight	28 g	28 g	28 g	28 g	28 g	28 g	45 g
Order quantity multiples	10 PC	10 PC	10 PC	10 PC	10 PC	10 PC	10 PC

Accessories			
Art. no.	9192001	9192002	9958020
Version	clip-in frame for uvex pheos standard size	clip-in frame for uvex pheos s narrow version	headband for uvex pheos and uvex pheos s
Colour	black	black	grey, black
Order quantity multiples	20 PC	20 PC	10 PC

MADE IN GERMANY 

Safety Spectacles

uvex i-3 · uvex i-3 guard



uvex i-3

- adjustable, multi-feature premium quality safety spectacle
- the combination of soft padding around the brow with ergonomically shaped side arms and soft-grip temple ends provide a comfortable, secure fit without pressure
- side arms with multi-incline points allow for a high level of individualisation to ensure a good fit for all facial shapes and head widths
- soft, adjustable nose pad allows spectacle to be adapted to the wearer to deliver a comfortable, non-slip and pressure-free fit
- robust polycarbonate lens with uvex's proven supravision coating technology – permanent anti-fog and scratch-resistant lens
- UV400 – 100 % protection against dangerous UVA and UVB radiation up to 400 nm
- optional clip-in frame seal provides extra protection against particles, dirt and dust
- available as standard size or narrow version
- metal-free

uvex i-3						uvex i-3 guard
Art. no.	9190270	9190175	9190275	9190280		9190180
Version	uvex supravision sapphire standard size	uvex supravision plus standard size	uvex supravision excellence standard size	uvex supravision excellence standard size		uvex supravision excellence standard size
Standard Frame	EN 166, EN 170 anthracite, blue W 166 FT CE	EN 166, EN 170 black, light grey W 166 FT CE	EN 166, EN 170 anthracite, blue W 166 FT CE	EN 166, EN 170 black, light grey W 166 FT CE		EN 166, EN 170 anthracite, blue W 166 FT CE
Lens	PC clear UV400	PC clear UV400	PC clear UV400	PC clear UV400		PC clear UV400
Weight	2C-1.2 W1 FTK CE 30 g	2C-1.2 W1 FTKN CE 30 g	2C-1.2 W1 FTKN CE 30 g	2C-1.2 W1 FTKN CE 30 g		2C-1.2 W1 FTKN CE 36 g
Order quantity multiples	10 PC	10 PC	10 PC	10 PC		10 PC

uvex i-3						
Art. no.	9190839	9190838	9190181	9190281	9190885	9190880
Version	uvex supravision AR standard size	uvex supravision AR standard size	uvex supravision plus standard size	uvex supravision excellence standard size	anti-fog on the inside standard size	uvex supravision variomatic standard size
	super anti-reflective lenses	super anti-reflective lenses	sunglare filter, oil & gas	sunglare filter	sunglare filter, silver mirror	self-tinting lenses
Standard Frame	EN 166, EN 170 black, blue W 166 FT CE	EN 166, EN 170 black, blue W 166 FT CE	EN 166, EN 172 black, light grey W 166 FT CE	EN 166, EN 172 black, light grey W 166 FT CE	EN 166, EN 172 black, light grey W 166 FT CE	EN 166, EN 170 black, anthracite W 166 FT CE
Lens	PC clear UV400	PC clear UV400	PC grey 23% UV400	PC grey 23% UV400	PC silver mirror grey UV400	PC light green UV400
Weight	2C-1.2 W1 FT CE 30 g	2C-1.2 W1 FT CE 30 g	5-2.5 W1 FTKN CE 30 g	5-2.5 W1 FTKN CE 30 g	5-3.1 W1 FTN CE 30 g	2-1.2 W1 FTKN CE 30 g
Order quantity multiples/ Order unit	10 PC	PC	10 PC	10 PC	10 PC	PC

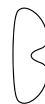

Safety Spectacles

uvex i-3 s · uvex i-3 s guard



9190065



9190080



9190075



9190680



9190039



9190085



9190086



Accessories: 9190001
Clip-in frame for uvex i-3 and uvex i-3 s



Accessories: 9958009
Eyewear cord for uvex i-3 and uvex i-3 s

uvex i-3 s	9190065	9190080	9190075	uvex i-3 s guard
Art. no.	9190065	9190080	9190075	9190680
Version	uvex supravision sapphire narrow version	uvex supravision plus narrow version	uvex supravision excellence narrow version	uvex supravision excellence narrow version
Standard Frame	EN 166, EN 170 blue, grey	EN 166, EN 170 black, grey	EN 166, EN 170 anthracite, lime	EN 166, EN 170 anthracite, blue
Lens	PC clear UV400	PC clear UV400	PC clear UV400	PC clear UV400
Weight	29 g	29 g	29 g	35 g
Order quantity multiples	10 PC	10 PC	10 PC	10 PC

uvex i-3 s	9190039	9190085	9190086	Accessories	9958009
Art. no.	9190039	9190085	9190086	9190001	9958009
Version	uvex supravision AR narrow version	uvex supravision excellence narrow version	uvex supravision excellence narrow version	clip-in frame for uvex i-3 and uvex i-3 s	eyewear cord for uvex i-3 and uvex i-3 s
Standard Frame	super anti-reflective lenses EN 166, EN 170	contrast-enhancing EN 166, EN 170	sunglare filter EN 166, EN 172	black	anthracite, grey
Lens	PC clear UV400	PC amber UV400	PC grey 23% UV400		
Weight	29 g	29 g	29 g	6 g	-
Order quantity multiples	10 PC	10 PC	10 PC	20 PC	10 PC

Safety Spectacles

uvex i-works



9194171



9194175



9194365



9194270



9194885

uvex i-works

- sporty, robust safety spectacle, available in a range of lens shades
- ergonomically shaped side arms with soft-grip temple ends provide a comfortable, secure fit without pressure
- nose bridge designed for all-day comfort
- robust polycarbonate lens with uvex's proven supravision coating technology – permanent anti-fog and scratch-resistant lens

- UV400 – 100 % protection against dangerous UVA and UVB radiation up to 400 nm
- fits the uvex IES
- metal-free

uvex i-works					
Art. no.	9194171	9194175	9194365	9194270	9194885
Version	uvex supravision excellence	uvex supravision excellence	uvex supravision excellence contrast-enhancing	uvex supravision excellence sunglare filter	anti-fog on the inside silver mirror
Standard	EN 166, EN 170	EN 166, EN 170	EN 166, EN 170	EN 166, EN 172	EN 166, EN 172
Frame	anthracite, blue	anthracite, green	black, yellow	anthracite, grey	black, grey
Lens	PC clear	PC clear	PC amber	PC grey 23%	PC silver mirror grey
	UV400	UV400	UV400	UV400	UV400
	2C-1.2 W1 FTKN CE	2C-1.2 W1 FTKN CE	2C-1.2 W1 FTKN CE	5-2.5 W1 FTKN CE	5-1.7 W1 FTN CE
Weight	26 g	26 g	26 g	26 g	26 g
Order quantity multiples	10 PC	10 PC	10 PC	10 PC	10 PC

MADE IN GERMANY

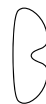

Safety Spectacles

uvex astrospec 2.0



9164065



9164187



9164285



9164275



9164276



9164246

uvex astrospec 2.0

- classic safety spectacle with flat lens for a wide field of vision
- ergonomically shaped side arms with multi-incline points allow for a high level of individualisation to ensure a good fit for all facial shapes and head widths
- side arms with soft-grip temple ends provide a comfortable, secure fit without pressure
- nose bridge designed for all-day comfort

- robust polycarbonate lens with uvex's proven supravision coating technology – permanent anti-fog and scratch-resistant lens
- UV400 – 100 % protection against dangerous UVA and UVB radiation up to 400 nm

uvex astrospec 2.0					uvex astrospec 2.0 CB	
Art. no.	9164065	9164187	9164285	9164275	9164276	9164246
Version	uvex supravision sapphire	uvex supravision plus oil & gas	uvex supravision excellence	uvex supravision extreme	uvex supravision extreme lower nose bridge, high cheekbone design, ISO 18526-4:2020	uvex supravision excellence sunglare filter
Standard Frame	EN 166, EN 170 blue, light blue W 166 FT CE	EN 166, EN 170 black, grey W 166 FT CE	EN 166, EN 170 black, lime W 166 FT CE	EN 166, EN 170 anthracite, petrol W 166 FT CE	EN 166, EN 170 blue, light blue W 166 FT CE	EN 166, EN 172 neon orange, black W 166 FT CE
Lens	PC clear UV400 2C-1.2 W1 FTK CE	PC clear UV400 2C-1.2 W1 FTKN CE	PC clear UV400 2C-1.2 W1 FTKN CE	PC clear UV400 2C-1.2 W1 FTKN CE	PC clear UV400 2C-1.2 W1 FTKN CE	PC grey 23% UV400 5-2.5 W1 FTKN CE
Weight	42 g	42 g	42 g	42 g	43 g	42 g
Order quantity multiples	10 PC	10 PC	10 PC	10 PC	10 PC	10 PC

MADE IN GERMANY

Safety Spectacles

uvex super g



9172085



9172110
9172210



9172265



9172281

uvex super g

- sporty, extremely lightweight safety spectacle with innovative temple concept for high levels of comfort
- flexible side arms with soft-grip temple ends provide a comfortable, secure fit without pressure
- soft, flexible nose pad for a non-slip and pressure-free fit
- robust polycarbonate lens with uvex's proven supravision coating technology – permanent anti-fog and scratch-resistant lens
- UV400 – 100 % protection against dangerous UVA and UVB radiation up to 400 nm
- metal-free

uvex super g					
Art. no.	9172085	9172110	9172210	9172265	9172281
Replacement lens	-	-	9172255	9172255	-
Version	uvex supravision sapphire	uvex supravision plus	uvex supravision excellence	uvex supravision excellence	uvex supravision excellence sunglare filter
Standard	EN 166, EN 170	EN 166, EN 170	EN 166, EN 170	EN 166, EN 170	EN 166, EN 172
Frame	grey metallic, black	clear, grey	clear, grey	navy blue, white	anthracite, lime
	W 166 FT CE	W 166 FT CE	W 166 FT CE	W 166 FT CE	W 166 FT CE
Lens	PC clear	PC clear	PC clear	PC clear	PC grey 23%
	UV400	UV400	UV400	UV400	UV400
	2C-1.2 W1 FTK CE	2C-1.2 W1 FTKN CE	2C-1.2 W1 FTKN CE	2C-1.2 W1 FTKN CE	5-2.5 W1 FTKN CE
Weight	18 g	18 g	18 g	18 g	18 g
Order quantity multiples	10 PC	10 PC	10 PC	10 PC	10 PC

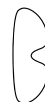

Safety Spectacles

uvex super fit



9178065
9178265



9178185



9178415



9178315



9178500



9178286

uvex super fit

- sporty safety spectacle with slim, flat side arms, making it highly compatible with other PPE
- the combination of soft padding around the brow with ergonomically shaped side arms and soft-grip temple ends provide a comfortable, secure fit without pressure
- soft, adjustable nose pad allows spectacle to be adapted to the wearer to deliver a comfortable, non-slip and pressure-free fit
- robust polycarbonate lens with uvex's proven supravision coating technology – permanent anti-fog and scratch-resistant lens
- UV400 – 100 % protection against dangerous UVA and UVB radiation up to 400 nm

uvex super fit				
Art. no.	9178065	9178185	9178415	9178265
Replacement lens	-	-	-	9172255
Version	uvex supravision sapphire	uvex supravision plus	uvex supravision ETC	uvex supravision excellence
Standard	EN 166, EN 170	EN 166, EN 170	EN 166, EN 170	EN 166, EN 170
Frame	navy blue, white W 166 FT CE	black, white W 166 FT CE	white, grey W 166 FT CE	navy blue, white W 166 FT CE
Lens	PC clear UV400 2C-1.2 W1 FTK CE	PC clear UV400 2C-1.2 W1 FTKN CE	PC clear UV400 2C-1.2 W1 FTN CE	PC clear UV400 2C-1.2 W1 FTKN CE
Weight	21 g	21 g	21 g	21 g
Order quantity multiples	10 PC	10 PC	10 PC	10 PC

uvex super fit				
Art. no.	9178315	9178500	9178286	
Replacement lens	9172255	-	-	
Version	uvex supravision excellence	uvex supravision clean autoclavable (20 cycles)	uvex supravision excellence sunglare filter	
Standard	EN 166, EN 170	EN 166, EN 170	EN 166, EN 172	
Frame	white, lime W 166 FT CE	white, light blue W 166 FT CE	black, white W 166 FT CE	
Lens	PC clear UV400 2C-1.2 W1 FTKN CE	PC clear UV400 2C-1.2 W1 FTKN CE	PC grey 23% UV400 5-2.5 W1 FTKN CE	
Weight	21 g	21 g	21 g	
Order quantity multiples	10 PC	10 PC	10 PC	

Safety Spectacles

uvex i-vo



9160065
9160265



9160185
9160285



9160275



9160520



9160076



9160120

uvex i-vo

- functional safety spectacle with a wide range of features and adjustment options
- side arms with multi-incline points and length adjustment allow spectacle to be adapted to ensure a good fit for all facial shapes and head widths
- soft-grip temple ends provide a comfortable, secure fit without pressure
- soft, flexible nose pad for a non-slip and pressure-free fit
- robust polycarbonate lens with uvex's proven supravision coating technology – permanent anti-fog and scratch-resistant lens
- UV400 – 100 % protection against dangerous UVA and UVB radiation up to 400 nm

uvex i-vo				
Art. no.	9160065	9160185	9160285	9160265
Version	uvex supravision sapphire	uvex supravision plus	uvex supravision excellence	uvex supravision excellence
Standard	EN 166, EN 170	EN 166, EN 170	EN 166, EN 170	EN 166, EN 170
Frame	blue, orange W 166 FT CE	blue, grey W 166 FT CE	blue, grey W 166 FT CE	blue, orange W 166 FT CE
Lens	PC clear UV400 2C-1.2 W1 FTK CE	PC clear UV400 2C-1.2 W1 FTKN CE	PC clear UV400 2C-1.2 W1 FTKN CE	PC clear UV400 2C-1.2 W1 FTKN CE
Weight	33 g	33 g	33 g	33 g
Order quantity multiples	10 PC	10 PC	10 PC	10 PC

Art. no.	9160275	9160520	9160076	9160120
Version	uvex supravision excellence	uvex supravision sapphire contrast-enhancing	uvex supravision sapphire sunglare filter	uvex supravision excellence with headband
Standard	EN 166, EN 170	EN 166, EN 170	EN 166, EN 172	EN 166, EN 170
Frame	black, grey W 166 FT CE	blue, orange W 166 FT CE	black, grey W 166 FT CE	–
Lens	PC clear UV400 2C-1.2 W1 FTKN CE	PC amber UV400 2C-1.2 W1 FTK CE	PC grey 23% UV400 5-2.5 W1 FTK CE	PC clear UV400 2C-1.2 W1 FTKN 166 F CE
Weight	33 g	33 g	33 g	32 g
Order quantity multiples	10 PC	10 PC	10 PC	10 PC

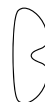

Safety Spectacles

uvex polavision · uvex skyguard NT



9231960

uvex polavision

- sporty dual lens safety spectacle with polarised filter
- uvex polavision technology protects against reflections and optical irritations outdoors helping to ease eye strain e.g. highly reflective surfaces such as water or glass
- side arms with soft-grip temple ends provide a comfortable, secure fit without pressure
- soft, flexible nose pad for a non-slip and pressure-free fit
- robust polycarbonate lens with UV400 – 100 % protection against dangerous UVA and UVB radiation up to 400 nm

uvex polavision	
Art. no.	9231960
Version	scratch-resistant on both sides sunglare filter
Standard	EN 166, EN 172
Frame	black, white W 166 F CE
Lens	PC grey 14% UV400 5-3.1 W 1 F CE
Weight	25 g
Order unit	PC



9175275



9175260
9175160



9175261

MADE IN GERMANY

uvex skyguard NT

- robust safety spectacle for all-round protection including protection against liquids and coarse dust (marking 3 and 4)
- soft, flexible face seal adapts to the wearer providing both protection and comfort
- side arms with multi-incline points and length adjustment allow spectacle to be adapted to ensure a good fit for all facial shapes and head widths
- soft-grip temple ends provide pressure-free comfort and a stable, non-slip fit (except 9175275)
- robust polycarbonate lens with uvex's proven supravision coating technology – permanent anti-fog and scratch-resistant lens
- UV400 – 100 % protection against dangerous UVA and UVB radiation up to 400 nm

uvex skyguard NT				
Art. no.	9175275	9175260	9175160	9175261
Version	uvex supravision excellence	uvex supravision excellence	uvex supravision extreme	uvex supravision excellence sunglare filter
Standard	EN 166, EN 170	EN 166, EN 170	EN 166, EN 170	EN 166, EN 172
Frame	grey, orange W 166 34 F CE	blue, grey W 166 34 F CE	blue, grey W 166 34 F CE	blue, grey W 166 34 F CE
Lens	PC clear UV400 2C-1.2 W1 FKN CE	PC clear UV400 2C-1.2 W1 FKN CE	PC clear UV400 2C-1.2 W1 FKN CE	PC grey 23% UV400 5-2.5 W1 FKN CE
Weight	42 g	44 g	44 g	44 g
Order quantity multiples	10 PC	10 PC	10 PC	10 PC

Safety Spectacles

uvex cybric · uvex meteor · uvex futura



uvex cybric

- functional dual lens safety spectacle
- side arms with multi-incline points and length adjustment allow spectacle to be adapted to ensure a good fit for all facial shapes and head widths
- soft-grip temple ends provide pressure-free comfort and a stable, non-slip fit
- nose bridge designed for all-day comfort
- robust polycarbonate lens with uvex's proven supravision coating technology – permanent anti-fog and scratch-resistant lens
- UV400 – 100 % protection against dangerous UVA and UVB radiation up to 400 nm

	uvex cybric		
Art. no.	9188075	9188175	9188076
Version	uvex supravision sapphire	uvex supravision plus	uvex supravision sapphire sunglare filter
Standard Frame	EN 166, EN 170 black, orange W 166 F CE	EN 166, EN 170 black, orange W 166 F CE	EN 166, EN 172 black, orange W 166 F CE
Lens	PC clear UV400 2C-1.2 W1 F CE	PC clear UV400 2C-1.2 W1 F CE	PC grey 23% UV400 5-2.5 W1 F CE
Weight	28 g	28 g	28 g
Order quantity multiples	10 PC	10 PC	10 PC



uvex meteor

- classic flat, dual lens safety spectacle with good coverage
- extendable soft-grip side arms offer adaptable, pressure-free comfort and a stable, non-slip fit
- nose bridge designed for all-day comfort
- robust polycarbonate lens with uvex's proven supravision coating technology – both sides scratch-resistant lens
- UV400 – 100 % protection against dangerous UVA and UVB radiation up to 400 nm
- metal-free

uvex meteor		
Art. no.	9134005	9134002
Version	uvex supravision sapphire lens 56 mm bridge width 15 mm	uncoated lens 56 mm bridge width 15 mm
Standard Frame	EN 166, EN 170 grey, transparent W 166 F CE	EN 166 grey transparent W 166 F CE
Lens	PC clear UV400 2-1.2 W1 FK	HG clear UV330 W1 S
Weight	28 g	44 g
Order quantity multiples	5 PC	5 PC

uvex futura

- robust dual lens safety spectacle with excellent, close fit
- side arms with multi-incline points and length adjustment allow spectacle to be adapted to ensure a good fit for all facial shapes and head widths
- soft-grip temple ends provide a comfortable, secure fit without pressure
- nose bridge designed for all-day comfort
- robust polycarbonate lens with uvex's proven supravision coating technology – permanent anti-fog and scratch-resistant lens
- UV400 – 100 % protection against dangerous UVA and UVB radiation up to 400 nm

uvex futura		
Art. no.	9180015	9180125
Version	uvex supravision sapphire	uvex supravision plus
Standard Frame	EN 166, EN 170 brown W 166 F CE	EN 166, EN 170 brown W 166 F CE
Lens	PC clear UV400 2C-1.2 W1 FK CE	PC clear UV400 2C-1.2 W1 FKN CE
Weight	49 g	49 g
Order quantity multiples	10 PC	10 PC

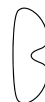

Safety Spectacles

uvex winner · uvex mercury · uvex ceramic



9159005
9159105



9159118

uvex winner

- classic, rimless metal safety spectacle
- side arms with soft-grip temple ends provide a secure fit without pressure
- soft, adjustable nose pad for a comfortable, non-slip and pressure-free fit
- robust polycarbonate lens with UV400 – 100 % protection against dangerous UVA and UVB radiation up to 400 nm

uvex winner			
Art. no.	9159005	9159105	9159118
Version	scratch-resistant on both sides	scratch-resistant, anti-fog	scratch-resistant, anti-fog sunglare filter
Standard Frame	EN 166, EN 170 gun W 166 F CE	EN 166, EN 170 gun W 166 F CE	EN 166, EN 172 gun W 166 F CE
Lens	PC clear UV400 2-1.2 W1 F CE	PC clear UV400 2-1.2 W1 FKN CE	PC grey 23% UV400 5-2.5 W1 FKN CE
Weight	29 g	29 g	29 g
Order quantity multiples	5 PC	5 PC	5 PC



9155005



9137005

MADE IN GERMANY

uvex mercury

- classic metal safety spectacle with flat design for easy stowage
- side arms with soft-grip temple ends provide a secure fit without pressure
- soft, adjustable loop style nose bridge delivers a comfortable, non-slip and pressure-free fit
- robust polycarbonate lens with uvex's proven supravision coating technology – both sides scratch-resistant lens
- UV400 – 100 % protection against dangerous UVA and UVB radiation up to 400 nm

uvex mercury	
Art. no.	9155005
Version	uvex supravision sapphire lens 54 mm bridge width 19 mm
Standard Frame	EN 166, EN 170 steel blue W 166 F CE
Lens	PC clear UV400 2C-1.2 W1 FK CE
Weight	30 g
Order quantity multiples	5 PC

uvex ceramic

- classic dual lens safety spectacle especially suitable for narrow facial shapes
- side arms with soft-grip temple ends provide a secure fit without pressure
- nose bridge designed for all-day comfort
- robust polycarbonate lens with UV400 – 100 % protection against dangerous UVA and UVB radiation up to 400 nm

uvex ceramic	
Art. no.	9137005
Version	uvex supravision sapphire lens 49 mm bridge width 20 mm
Standard Frame	EN 166, EN 170 grey, black W 166 F CE
Lens	PC clear UV400 2C-1.2 W1 FK CE
Weight	23 g
Order quantity multiples	5 PC

Overspecs

uvex 9161 · uvex super OTG



9161014



9161005
9161305

uvex 9161

- robust overspecs for prescription spectacle wearers with flat lens for a wide field of vision
- side arms with multi-incline points and length adjustment allow overspecs to be adapted to ensure a good fit for all facial shapes and head widths (except 9161014)
- soft-grip temple ends provide pressure-free comfort and a stable, non-slip fit (except 9161014)
- nose bridge designed for all-day comfort
- robust polycarbonate lens with uvex's proven supravision coating technology – permanent anti-fog and scratch-resistant lens
- UV400 – 100 % protection against dangerous UVA and UVB radiation up to 400 nm
- metal-free

uvex 9161			
Art. no.	9161014	9161005	9161305
Version	uncoated	uvex supravision sapphire	uvex supravision plus
Standard	EN 166, EN 170	EN 166, EN 170	EN 166, EN 170
Frame	clear	blue, black	blue, black
	W 166 F CE	W 166 F CE	W 166 F CE
Lens	PC clear	PC clear	PC clear
	UV400	UV400	UV400
	2C-1.2 W1 F CE	2C-1.2 W1 FK CE	2C-1.2 W1 FKN CE
Weight	51 g	46 g	46 g
Order quantity multiples	5 PC	5 PC	5 PC



9169065
9169260



9169080



9169081

uvex super OTG

- classic overspecs for prescription spectacle wearers with an innovative temple concept and a flat lens that offers a wide field of vision
- flexible side arms with soft-grip temple ends provide a comfortable, secure fit without pressure
- nose bridge designed for all-day comfort
- robust polycarbonate lens with uvex's proven supravision coating technology – permanent anti-fog and scratch-resistant lens
- UV400 – 100 % protection against dangerous UVA and UVB radiation up to 400 nm
- metal-free

uvex super OTG			
Art. no.	9169065	9169080	9169260
Version	uvex supravision sapphire	uvex supravision sapphire	uvex supravision excellence
Standard	EN 166, EN 170	EN 166, EN 170	EN 166, EN 170
Frame	blue, light grey	black, light grey	blue, light grey
	W 166 FT CE	W 166 FT CE	W 166 FT CE
Lens	PC clear	PC clear	PC clear
	UV400	UV400	UV400
	2C-1.2 W1 FTK CE	2C-1.2 W1 FTK CE	2C-1.2 W1 FTKN CE
Weight	37 g	37 g	37 g
Order quantity multiples	8 PC	8 PC	8 PC



Overspecs

uvex super f OTG



9169585
9169261



9169500



9169164



9169586



9169850



9169615

uvex super f OTG

- classic overspecs for prescription spectacle wearers with a flat lens for a wide field of vision, designed for maximum wearer acceptance
- side arms with soft-grip temple ends provide a comfortable, secure fit without pressure
- nose bridge designed for all-day comfort

- robust polycarbonate lens with uvex's proven supravision coating technology – permanent anti-fog and scratch-resistant lens
- UV400 – 100 % protection against dangerous UVA and UVB radiation up to 400 nm

uvex super f OTG							
Art. no.	9169585	9169261	9169500	9169164	9169586	9169850	9169615
Version	uvex supravision sapphire	uvex supravision excellence	uvex supravision clean autoclavable (20 cycles)	uvex supravision excellence sunglare filter	uvex supravision sapphire sunglare filter	uvex supravision variomatic	uvex supravision sapphire blocks blue light to 525 nm
Standard Frame	EN 166, EN 170 black, white W 166 FT CE	EN 166, EN 170 black, white W 166 FT CE	EN 166, EN 170 white, light blue W 166 FT CE	EN 166, EN 172 black, white W 166 FT CE	EN 166, EN 172 black, white W 166 FT CE	EN 166, EN 170 black, white W 166 FT CE	EN 166, EN 170 black, white W 166 FT CE
Lens	PC clear UV400 2C-1.2 W1 FTK CE	PC clear UV400 2C-1.2 W1 FTKN CE	PC clear UV400 2C-1.2.1 FTKN CE	PC CBR65 UV400 5-1.4 W1 FTKN CE	PC grey 23% UV400 5-2.5 W1 FTK CE	PC light green UV400 2-1.2 W1 FTKN CE	PC orange UV525 2-1.4 W1 FTK CE
Weight	39 g	39 g	39 g	39 g	39 g	39 g	39 g
Order quantity multiples/ Order unit	8 PC	8 PC	8 PC	8 PC	8 PC	PC	8 PC

MADE IN GERMANY

uvex

uvex megasonic Visionary technologies at a glance

The uvex megasonic's revolutionary lens design does not restrict the wearer's field of vision, meaning users have the clearest possible view at all times – even under difficult conditions. It has a sporty, ergonomic design and is extremely comfortable to wear, making it a piece of equipment you can depend on during your everyday work.



Frameless and innovative lens design
for an optimum, unrestricted view



x-frame design
for flexible adjustment
to any face



reddot winner 2020



Ergonomic face piece
for a perfect fit and
maximum comfort



Fits comfortably over most prescription glasses
thanks to the unique frame design



uvex supravision
coating technology



Extra-wide headband
for an optimal fit and
extra wearer comfort

MADE IN GERMANY

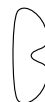

Safety Goggles

uvex megasonic



9320415
9320265



9320500



9320223



9320281

uvex megasonic

- functional safety goggle in ski goggle design with a truly panoramic field of vision
- unique frameless lens design for edge-to-edge optical clarity and increased safety
- soft, adaptive face seal providing a universal fit for different head and facial shapes as well as a tight fit without pressure points
- generous internal volume to accommodate prescription spectacles and frame recesses to locate the side arms ensuring a comfortable fit
- indirect ventilation system increases air circulation
- length-adjustable 30 mm wide textile headband for optimal low pressure hold and individual adaptability

- robust polycarbonate lens with uvex's proven supravision coating technology – permanent anti-fog and scratch-resistant lens
- UV400 – 100 % protection against dangerous UVA and UVB radiation up to 400 nm
- a sustainable benefit: lenses and headbands can be replaced when required
- metal-free



reddot winner 2020



Further information can be found at uvex-safety.com/en/megasonic (or scan the QR code).

uvex megasonic					
Art. no.	9320265	9320415	9320500	9320223	9320281
Replacement lens	9320255	9320455	-	-	9320257
Replacement headband	9320011	9320011	-	-	9320012
Version	uvex supravision excellence	uvex supravision ETC	uvex supravision clean autoclavable (20 cycles)	uvex supravision excellence sunglare filter	uvex supravision excellence sunglare filter
Standard	EN 166, EN 170	EN 166, EN 170	EN 166, EN 170	EN 166, EN 172	EN 166, EN 172
Frame	anthracite, blue W 166 34 BT CE	anthracite, blue W 166 34 BT CE	transparent, white W 166 34 BT CE	black, grey W 166 34 BT CE	anthracite, lime W 166 34 BT CE
Lens	PC clear UV400	PC clear UV400	PC clear UV400	PC CBR23 UV400	PC grey 23% UV400
Weight	2C-1.2 W1 BTKN CE 96 g	2C-1.2 W1 BTKN CE 96 g	2C-1.2 W1 BTKN CE 107 g	5-2.5 W1 BTKN CE 96 g	5-2.5 W1 BTKN CE 96 g
Order quantity multiples	4 PC	4 PC	4 PC	4 PC	4 PC

MADE IN GERMANY

Safety Goggles

uvex pheos cx2 sonic



9309275



9309064



9309286

uvex pheos cx2 sonic

- sporty, compact and extremely lightweight safety goggle
- very soft and flexible, ergonomic face seal for a custom fit and ultimate comfort
- indirect ventilation system increases air circulation
- very light, length-adjustable textile headband for a secure fit and individual adaptability
- robust polycarbonate lens with uvex's proven supravision coating technology – permanent anti-fog and scratch-resistant lens
- UV400 – 100 % protection against dangerous UVA and UVB radiation up to 400 nm
- metal-free

uvex pheos cx2 sonic			
Art. no.	9309275	9309064	9309286
Version	uvex supravision extreme	uvex supravision extreme sunglare filter	uvex supravision extreme sunglare filter
Standard	EN 166, EN 170	EN 166, EN 172	EN 166, EN 172
Frame	white, black W 166 34 BT CE	white, black W 166 34 BT CE	white, black W 166 34 BT CE
Lens	PC clear UV400 2C-1.2 W1 BTKN CE	PC CBR65 UV400 5-1.4 W1 BTKN CE	PC grey 23% UV400 5-2.5 W1 BTKN CE
Weight	34 g	34 g	34 g
Order quantity multiples	10 PC	10 PC	10 PC

MADE IN GERMANY 

uvex academy
Industrial protective eyewear



A practical introductory seminar on the selection, use and benefits of protective eyewear

- The basic applications of safety eyewear, including which products protect against mechanical dangers, chemical and radiation risks (e.g. welding protection), and products designed for specialised applications
- Demonstration and assessment of the dangers posed by mechanical risks, infrared and ultraviolet radiation (e.g. encountered during welding applications or during the use of chemicals), illustrated by case studies
- Assessment of the risk of eye injury in the workplace
- Explanation of how these risks can be dealt with efficiently in each workplace
- Comprehensive overview of the requirements of industrial safety eyewear, standards, applications, risk assessment and how to care for protective eyewear
- Information on the classification of protection products based on their labelling and the areas of application of the various types of equipment

Target group

Those responsible for the work-related health and safety of employees within a company, e.g. health and safety officers, occupational nurses and specialist purchasers



For more information or to book a place, please visit uvex-academy.de, call +49 (0)911 9736 1710 or email academy@uvex.de

uvex

uvex CR

Autoclave safety eyewear that goes further

Innovative coating technology –
the first autoclavable safety eyewear
with anti-fog performance

uvex has developed the first autoclavable safety eyewear with anti-fog coating for specialist requirements in laboratories, clinics, cleanrooms and food manufacturing. From ultra-light safety spectacles and goggles with a panoramic lens, the uvex CR is the ideal safety eyewear for all areas of application and specifically have been designed for repeated autoclave sterilisation (20 times for 20 minutes each at a max. of 121°C).

uvex CR – professional safety eyewear that compliments hygiene standards.



9178500



9169500

uvex super fit CR

- sporty safety spectacle with slim, flat side arms, making it highly compatible with other PPE
- the combination of soft padding around the brow with ergonomically shaped side arms and soft-grip temple ends provide a comfortable, secure fit without pressure
- soft, adjustable nose pad allows spectacle to be adapted to the wearer to deliver a comfortable, non-slip and pressure-free fit
- robust polycarbonate lens with uvex's proven supravision coating technology – permanent anti-fog and scratch-resistant lens
- UV400 – 100 % protection against dangerous UVA and UVB radiation up to 400 nm



9320500

uvex super f OTG CR

- classic overspecs for prescription spectacle wearers with a flat lens for wide field of vision, designed for maximum wearer acceptance
- side arms with soft-grip temple ends provide a comfortable, secure fit without pressure
- nose bridge designed for all-day comfort
- robust polycarbonate lens with uvex's proven infradur coating technology – permanent anti-fog and scratch-resistant lens
- UV400 – 100 % protection against dangerous UVA and UVB radiation up to 400 nm



9302500

uvex megasonic CR

- functional safety goggles in ski goggle design with a truly panoramic field of vision
- unique frameless lens design for edge-to-edge optical clarity and increased safety
- soft, adaptive face seal providing a universal fit for different head and facial shapes as well as a tight fit without pressure points
- generous internal volume to accommodate prescription spectacles and frame recesses to locate the side arms ensuring a comfortable fit
- indirect ventilation system increases air circulation
- length-adjustable 30 mm wide silicone headband for optimal low pressure hold and individual adaptability
- robust polycarbonate lens with uvex's proven supravision coating technology – permanent anti-fog and scratch-resistant lens
- UV400 – 100% protection against dangerous UVA and UVB radiation up to 400 nm
- metal-free

uvex ultrasonic CR

- functional safety goggle with panoramic lens suitable for a wide range of applications
- soft, flexible face seal naturally moulds to any facial shape
- generous internal volume to accommodate prescription spectacles and ensure a comfortable fit
- indirect ventilation system increases air circulation
- length-adjustable silicone headband for a secure fit and individual adaptability
- robust polycarbonate lens with uvex's proven supravision coating technology – permanent anti-fog and scratch-resistant lens
- UV400 – 100 % protection against dangerous UVA and UVB radiation up to 400 nm
- a sustainable benefit: lenses can be replaced when required
- metal-free

MADE IN GERMANY 



Safety Goggles

uvex ultrasonic



9302245



9302285



9302275



9302601



9302600



9302500



9302286

uvex ultrasonic

- functional safety goggle with panoramic lens suitable for a wide range of applications
- soft, flexible face seal naturally moulds to any facial shape
- generous internal volume to accommodate prescription spectacles and ensure a comfortable fit
- indirect ventilation system increases air circulation
- length-adjustable textile or silicone headband for a secure fit and individual adaptability
- robust polycarbonate lens with uvex's proven supravision coating technology – permanent anti-fog and scratch-resistant lens
- UV400 – 100 % protection against dangerous UVA and UVB radiation up to 400 nm
- a sustainable benefit: lenses can be replaced when required
- metal-free

uvex ultrasonic				
Art. no.	9302245	9302285	9302275	9302601
Replacement lens	9302255	9302255	9302155	9302155
Version	uvex supravision excellence	uvex supravision excellence	uvex supravision extreme	uvex supravision extreme reduced ventilation
Standard Frame	EN 166, EN 170 grey, orange W 166 34 B CE	EN 166, EN 170 black, grey W 166 34 B CE	EN 166, EN 170 anthracite, lime W 166 34 B CE	EN 166, EN 170 black, red W 166 34 B CE
Lens	PC clear, UV400 2C-1.2 W1 BKN CE	PC clear, UV400 2C-1.2 W1 BKN CE	PC clear, UV400 2C-1.2 W1 BKN CE	PC clear, UV400 2C-1.2 W1 BKN CE
Weight	83 g	83 g	83 g	95 g
Order quantity multiples	4 PC	4 PC	4 PC	4 PC

uvex ultrasonic			
Art. no.	9302600	9302500	9302286
Replacement lens	9302155	9302259	9302256
Version	uvex supravision extreme reduced ventilation	uvex supravision clean autoclavable (20 cycles)	uvex supravision excellence sunglare filter
Standard Frame	EN 166, EN 170 blue, grey W 166 34 B CE	EN 166, EN 170 transparent, white W 166 34 B CE	EN 166, EN 172 black, grey W 166 34 B CE
Lens	PC clear, UV400 2C-1.2 W1 BKN CE	PC clear, UV400 2C-1.2 W1 BKN CE	PC grey 23%, UV400 5-2.5 W1 BKN CE
Weight	95 g	95 g	83 g
Order quantity multiples	4 PC	4 PC	4 PC

MADE IN GERMANY

Safety Goggles

uvex ultravision



9301714



9301906



9301716



9301424

Please note:
CA lenses do not fit the PC models
and vice-versa.

uvex ultravision

- classic safety goggle suitable for a wide range of applications
- flexible face seal naturally moulds to any facial shape
- generous internal volume accommodating prescription spectacles and frame recesses to locate the side arms ensuring a comfortable fit
- indirect ventilation system increases air circulation
- length-adjustable textile or neoprene headband for a secure fit and individual adaptability
- robust polycarbonate lens with uvex's proven supravision coating technology – permanent anti-fog and scratch-resistant lens
- UV400 – 100 % protection against dangerous UVA and UVB radiation up to 400 nm
- also available with a cellulose acetate lens featuring anti-fog performance on the inside and UV380 protection
- a sustainable benefit: lenses can be replaced when required
- metal-free

uvex ultravision				
Art. no.	9301714	9301906	9301716	9301424
Replacement lens	9300517	9300956	9300517	9300517
Version	anti-fog on the inside	anti-fog on the inside wide nose piece, particularly well suited in combination with dust masks	anti-fog on the inside with foam layer	anti-fog on the inside with neoprene headband
Standard	EN 166, EN 170	EN 166, EN 170	EN 166, EN 170	EN 166, EN 170
Frame	transparent grey W 166 34 F CE	transparent grey W 166 3 F CE	transparent grey W 166 34 F CE	transparent grey W 166 34 F CE
Lens	CA clear UV380 2C-1.2 W1 FN CE	CA clear UV380 2C-1.2 W1 FN CE	CA clear UV380 2C-1.2 W1 FN CE	CA clear UV380 2C-1.2 W1 FN CE
Weight	116 g	130 g	118 g	108 g
Order quantity multiples	4 PC	4 PC	4 PC	4 PC



Safety Goggles

uvex ultravision



9301605



9301116



9301105



9301626



9301813



9301815



9301613



9301633



9301064

uvex ultravision					
Art. no.	9301605	9301116	9301105	9301626	9301813
Replacement lens	-	-	9301255	9301255	9301255
Tear-off films	-	-	-	-	9300316
Version	uvex supravision plus	uvex supravision plus with foam layer	uvex supravision excellence	uvex supravision excellence with foam layer	uvex supravision excellence with tear-off films, 2 units
Standard	EN 166, EN 170	EN 166, EN 170	EN 166, EN 170	EN 166, EN 170	EN 166, EN 170
Frame	transparent grey	transparent grey	transparent grey	transparent grey	transparent grey
	W 166 34 BT CE	W 166 34 BT CE	W 166 34 BT CE	W 166 34 BT CE	W 166 34 BT CE
Lens	PC clear	PC clear	PC clear	PC clear	PC clear
	UV400	UV400	UV400	UV400	UV400
	2C-1.2 W1 BTKN CE	2C-1.2 W1 BTKN CE	2C-1.2 W1 BTKN CE	2C-1.2 W1 BTKN CE	2C-1.2 W1 BTKN CE
Weight	131 g	134 g	131 g	134 g	126 g
Order quantity multiples	4 PC	4 PC	4 PC	4 PC	4 PC

Art. no.	9301815	9301613	9301633	9301064
Replacement lens	9301255	9301255	9301255	-
Tear-off films	-	-	-	-
Version	uvex supravision excellence top ventilation closed	uvex supravision excellence closed ventilation (gas-proof)	uvex supravision excellence closed ventilation (gas-proof) heat-resistant frame material	uvex supravision excellence sunglare filter
Standard	EN 166, EN 170	EN 166, EN 170	EN 166, EN 170	EN 166, EN 172
Frame	transparent grey	yellow	red	transparent grey
	W 166 34 BT CE	W 166 345 BT CE	W 166 345 BT CE	W 166 34 BT CE
Lens	PC clear	PC clear	PC clear	PC CBR65
	UV400	UV400	UV400	UV400
	2C-1.2 W1 BTKN CE	2C-1.2 W1 BTKN CE	2C-1.2 W1 BTKN CE	5-1.4 W1 BTKN CE
Weight	131 g	133 g	133 g	131 g
Order quantity multiples	4 PC	4 PC	4 PC	4 PC

MADE IN GERMANY

Safety Goggles

uvex ultravision faceguard · helmet mounted safety goggles



9301555
Safety Goggle: 9301105



9301317



9301318

uvex ultravision faceguard

- combination of safety goggle with face guard
- protection for eyes and face
- 9301555 or 9301318: Lifting mechanism allows flexible handling during use e.g. communication, drinking, etc.

	Goggles with face protection	Face protection	Face protection
Art. no.	9301555	9301317	9301318
Version	Goggles with uvex supravision excellence (9301105) with faceguard (9301318)	for all models 9301 with PC lens without spectacles uncoated	for all models 9301 with PC lens without spectacles uncoated
Standard	EN 166, EN 170	-	-
Frame	transparent grey	transparent	transparent
	W 166 34 BT CE	CE	CE
Lens	PC clear	-	-
	UV400	-	-
	2C-1.2 W1 BTKN CE	-	-
Weight	212 g	64 g	81 g
Order quantity multiples/	4 PC	PC	PC
Order unit			



9302510



9301544



9924010

Helmet mounted safety goggles uvex ultrasonic and uvex ultravision

- safety goggle for combination with helmet and safety earmuffs uvex K1H or uvex K2H (safety earmuffs are not included)
- for attaching the uvex ultrasonic or the uvex ultravision without safety earmuffs, additional adapters (item no. 9924010) are required

	uvex ultrasonic	uvex ultravision	Adapter
Art. no.	9302510	9301544	9924010
Replacement lens	9302155	-	-
Version	uvex supravision extreme reduced ventilation	anti-fog on the inside	Adapter for attaching without earmuffs
Standard	EN 166, EN 170	EN 166, EN 170	
Frame	blue, grey	transparent grey	
	W 166 34 B CE	W 166 34 F CE	
Lens	PC clear	CA clear	
	UV400	UV380	
	2C-1.2 W1 BKN CE	2C-1.2 W1 FN CE	
Weight	121 g	132 g	-
Order quantity multiples	4 PC	4 PC	4 PC
Content	-	-	1 pair



Safety Goggles

uvex carbonvision · uvex 9305 · uvex 9405



9307375



9307365

uvex carbonvision

- classic, lightweight safety goggle
- soft, flexible face seal naturally moulds to any facial shape
- indirect ventilation system increases air circulation
- length-adjustable textile or neoprene headband for a secure fit and individual adaptability
- robust polycarbonate lens with uvex's proven supravision coating technology – permanent anti-fog and scratch-resistant lens
- UV400 – 100 % protection against dangerous UVA and UVB radiation up to 400 nm
- metal-free

uvex carbonvision		
Art. no.	9307375	9307365
Version	uvex supravision extreme	uvex supravision extreme with neoprene headband
Standard Frame	EN 166, EN 170 black, grey W 166 34 B CE	EN 166, EN 170 black, grey W 166 34 B CE
Lens	PC clear UV400 2C-1.2 W1 BKN CE	PC clear UV400 2C-1.2 W1 BKN CE
Weight	46 g	51 g
Order quantity multiples	10 PC	10 PC



9305514

9305714



9405714



uvex 9305

- classic safety goggle
- flexible face seal naturally moulds to any facial shape
- internal volume comfortably accommodates prescription spectacles
- indirect ventilation system increases air circulation
- length-adjustable textile or rubber headband for a secure fit and individual adaptability
- cellulose acetate lens with anti-fog performance on the inside and UV380 protection
- metal-free

uvex 9305		
Art. no.	9305514	9305714
Version	anti-fog on the inside with rubber headband	anti-fog on the inside with textile headband
Standard Frame	EN 166, EN 170 transparent grey W 166 34 F CE	EN 166, EN 170 transparent grey W 166 34 F CE
Lens	CA clear UV380 2C-1.2 W1 FN CE	CA clear UV380 2C-1.2 W1 FN CE
Weight	95 g	91 g
Order quantity multiples	4 PC	4 PC

uvex 9405

- classic safety goggle
- flexible face seal naturally moulds to any facial shape
- internal volume comfortably accommodates prescription spectacles
- indirect ventilation system increases air circulation
- length-adjustable textile headband for a secure fit and individual adaptability
- cellulose acetate lens with anti-fog performance on the inside and UV380 protection
- metal-free

uvex 9405	
Art. no.	9405714
Version	anti-fog on the inside
Standard Frame	EN 166, EN 170 transparent grey W 166 34 F CE
Lens	CA clear UV380 2C-1.2 W1 FN CE
Weight	84 g
Order quantity multiples	4 PC

Welding Protection

A new generation of welding protection eyewear available with different grey-tint lenses and protection classes. The innovative technology affords protection from UV and infrared light while maintaining perfect colour recognition in line with uvex sunglare filters.

The special uvex infradur plus coating has anti-fog properties which prevents the inside of the lenses misting up and the extreme scratch-resistance on the outside keeps damage from welding sparks to an absolute minimum.

With various welding safety spectacles and goggle solutions, there is something for everyone – enhancing comfort and the wearer experience.

N.B.: Do not use for electric welding.



All welding products have polycarbonate lenses providing protection against impact as well as UV rays, IR rays and visible glare.

The products do not provide protection against laser beams!

For expert advice on safety and in selecting the right laser protection eyewear, talk to our specialists

laservision

Call them on +49 (0)911 9736 8100.

New grey tint offers increased impact protection than traditional green welding tint products

IR/UV filter for improved safety

Sun/glare protection filters

Perfect colour recognition



Marking K and N for uvex infradur plus coated lenses

uvex-laservision.com

Levels of welding protection and recommendations for use according to EN 169

Level of protection	Use
1.7	For welding assistants, protection against UV radiation and bright scattered light
2	Lightweight oxyacetylene cutting
3	Flame derusting, flame cutting, lightweight oxyacetylene cutting
4	Welding and hard soldering with up to 70 l/h of acetylene, flame cutting with up to 900 l/h of oxygen, steel and grey cast iron welding, lightweight oxyacetylene cutting
5	Welding and hard soldering with 70 to 200 l/h of acetylene, flame cutting with 2000 to 4000 l/h of oxygen
6	Welding and hard soldering with 200 to 800 l/h of acetylene, flame cutting with 2000 to 4000 l/h of oxygen

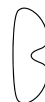

Welding Protection

uvex i-5 · uvex futura



uvex i-5

- sporty premium quality welding safety spectacle with a range of adaptive features
- x-tended eyeshield: soft seal frame technology wraps around the brow providing protection from particle ingress
- x-tended sideshield offers additional protection from hazards
- ergonomically shaped side arms with multi-incline points and length adjustment allow a high level of individualisation to ensure a good fit for all facial shapes and head widths
- soft-grip temple ends provide a comfortable, secure fit without pressure
- soft, flexible nose pad adapts to the wearer, delivering a non-slip and pressure-free fit
- robust polycarbonate lens with uvex's proven infraradur coating technology – permanent anti-fog and scratch-resistant lens
- IR protection according to EN 169 with perfect colour recognition according to EN 172
- UV400 – 100 % protection against dangerous UVA and UVB radiation up to 400 nm
- optional clip-in frame seal provides extra protection against particles, dirt and dust
- metal-free

uvex i-5			
Art. no.	9183041	9183043	9183045
Version	uvex infradur plus welding protection level 1.7	uvex infradur plus welding protection level 3	uvex infradur plus welding protection level 5
Standard	EN 166, EN 169	EN 166, EN 169	EN 166, EN 169
Frame	black, green W 166 FT CE	black, green W 166 FT CE	black, green W 166 FT CE
Lens	PC grey UV400 + IR 1,7 W1 FTKN CE	PC grey UV400 + IR 3 W1 FTKN CE	PC grey UV400 + IR 5 W1 FTKN CE
Weight	29 g	29 g	29 g
Order quantity multiples	10 PC	10 PC	10 PC



uvex futura

- robust dual lens welding safety spectacle with excellent, close fit
- side arms with multi-incline points and length adjustment allow spectacle to be adapted to ensure a good fit for all facial shapes and head widths
- side arms with soft-grip temple ends provide a secure fit without pressure
- nose bridge designed for all-day comfort
- robust polycarbonate lens with uvex's proven infradur coating technology – both sides scratch-resistant lens
- IR protection according to EN 169 with perfect colour recognition according to EN 172
- UV400 – 100 % protection against dangerous UVA and UVB radiation up to 400 nm

uvex futura	
Art. no.	9180145
Version	uvex infradur welding protection level 5
Standard	EN 166, EN 169
Frame	black, green W 166 F CE
Lens	PC grey UV400 + IR 5 W1 FTKN CE
Weight	49 g
Order quantity multiples	10 PC

Welding Protection

uvex super f OTG · uvex megasonic · uvex ultrasonic



9169541



9169543



9169545

uvex super f OTG

- classic welding overspecs for prescription spectacle wearers with a flat lens for wide field of vision, designed for maximum wearer acceptance
- side arms with soft-grip temple ends provide a comfortable, secure fit without pressure
- nose bridge designed for all-day comfort
- robust polycarbonate lens with uvex's proven infraradur coating technology – permanent anti-fog and scratch-resistant lens
- IR protection according to EN 169 with perfect colour recognition according to EN 172
- UV400 – 100 % protection against dangerous UVA and UVB radiation up to 400 nm

uvex super f OTG			
Art. no.	9169541	9169543	9169545
Version	uvex infraradur plus welding protection level 1.7	uvex infraradur plus welding protection level 3	uvex infraradur plus welding protection level 5
Standard	EN 166, EN 169	EN 166, EN 169	EN 166, EN 169
Frame	black, green W 166 FT CE	black, green W 166 FT CE	black, green W 166 FT CE
Lens	PC grey UV400 + IR 1.7 W1 FTKN CE	PC grey UV400 + IR 3 W1 FTKN CE	PC grey UV400 + IR 5 W1 FTKN CE
Weight	39 g	39 g	39 g
Order quantity multiples	5 PC	5 PC	5 PC



9320045

uvex megasonic

- functional welding safety goggle in a ski goggle design and a truly panoramic field of vision
- unique frameless lens design for edge-to-edge optical clarity and increased safety
- soft, adaptive face seal providing a universal fit for different head and face shapes as well as a tight fit without pressure points
- generous internal volume to accommodate prescription eyewear and frame recesses to locate the side arms ensuring a comfortable fit
- indirect ventilation system increases air circulation
- length-adjustable 30 mm wide textile headband
- robust polycarbonate lens with uvex's proven infraradur coating technology – permanent anti-fog and scratch-resistant lens
- IR protection according to EN 169 with perfect colour recognition according to EN 172
- UV400 – 100 % protection against dangerous UVA and UVB radiation up to 400 nm
- metal-free

uvex megasonic	
Art. no.	9320045
Version	uvex infraradur plus welding protection level 5
Standard	EN 166, EN 169
Frame	black W 166 34 BT CE
Lens	PC grey UV400 + IR 5 W1 BTKN CE
Weight	96 g
Order quantity multiples	4 PC



9302045

uvex ultrasonic

- functional welding safety goggle with panoramic and flip-up lens for an increased use of applications
- soft, flexible face seal naturally moulds to any facial shape
- generous internal volume to accommodate prescription spectacles and ensure a comfortable fit
- indirect ventilation system increases air circulation
- length-adjustable textile headband for a secure fit and individual adaptability
- robust polycarbonate lens with uvex's proven supravision and infraradur coating technology – permanent anti-fog and scratch-resistant lens
- IR protection according to EN 169 with perfect colour recognition according to EN 172
- UV400 – 100 % protection against dangerous UVA and UVB radiation up to 400 nm
- a sustainable benefit: lenses can be replaced when required
- metal-free

uvex ultrasonic	
Art. no.	9302045
Replacement lens flip-up	9302085
Version	uvex supravision excellence with flip-up and easily replaceable filter
Standard	EN 166, EN 169, EN 170
Frame	black, green
Lens	W 166 34 B CE PC clear, UV400 2C-1,2 W1 BKN CE PC grey, UV400 + IR uvex infraradur, 5 W1 CE welding protection level 5
Additional lens	
Weight	123 g
Order quantity multiples	4 PC

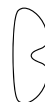

Accessories

uvex cleaning accessories · Presentation



9970005



9972101



9963000

uvex eyewear cleaning station

- including
2 x 9971000
1 x 9972103
1 x 9973101

Plastic pump

- for uvex cleaning fluid 9972103

uvex cleaning fluid

- 500 ml cleaning fluid
- suitable for all uvex lenses

Cleaning paper

- replacement pack silicone-free paper
- approx. 760 sheets
- antistatic
- suitable for all uvex lenses

Magnetic wall bracket

- for easy mounting of the uvex cleaning station (9970005)

uvex eyewear cleaning station
Art. no. 9970005
Order unit PC

Plastic pump
Art. no. 9973101
Order unit PC

uvex cleaning fluid
Art. no. 9972103
Content 500 ml
Order unit PC

Cleaning papers
Art. no. 9971000
Order unit PC

Magnetic wall bracket
Art. no. 9963004
Order unit PC

uvex cleaning fluid

- 500 ml cleaning fluid
- suitable for all uvex lenses
- Note: does not fit in the cleaning stations (9970005 and 9970002).

uvex cleaning fluid
Art. no. 9972101
Content 500 ml
Order unit PC

- Note:
spare parts for 9970002

uvex cleaning fluid
Art. no. 9972100
Content 500 ml
Order unit PC

Plastic pump
Art. no. 9973100
Order unit PC

Spare parts for uvex cleaning station 9970002 only

uvex lens cleaning towelettes

- 100 towelettes per box
- individually packed
- silicone-free
- not antistatic
- suitable for all uvex lenses

uvex cleaning towelettes
Art. no. 9963000
Order unit PC



9972130

uvex microfibre cloth

- suitable for cleaning all uvex lenses

uvex microfibre cloth
Art. no. 9972130
Order unit BG
Content 5 PC



9957503

uvex display

- with integrated mirror
- for four safety spectacles and one safety goggle

uvex Display
Art. no. 9957503
Order unit PC

Accessories Storage



9954600

uvex eyewear case

- extremely robust hard case for protection against external influences
- soft embedded inside
- with belt loop
- practical snap hook
- especially suitable for curved safety eyewear (e.g. uvex i-vo)



9954500

uvex eyewear case

- robust case
- additional space for spare lens
- reinforced zipper
- with belt loop
- suitable for all uvex safety spectacles



9954501

uvex eyewear case

- large and robust case
- additional space for spare lens
- with belt loop
- suitable for all uvex safety spectacles and goggles

uvex eyewear case		
Art. no.	9954600	9954500
Order quantity multiples	10 PC	10 PC
		9954501
		10 PC



6118002

uvex eyewear case

- flexible case made of robust nylon material
- Velcro fastener individually adjustable
- extendable by zipper on the side
- with belt loop
- suitable for all uvex safety spectacles



9954355

uvex microfibre bag

- elegant microfibre bag
- suitable for all uvex safety spectacles



9954360

uvex microfibre bag

- elegant microfibre bag
- suitable for all uvex safety overspecs and safety goggles

uvex eyewear case		uvex microfibre bag	
Art. no.	6118002	9954355	9954360
Order quantity multiples	10 PC	10 PC	10 PC



9954326

uvex carry case

- with flexible adjustable storage compartments (by Velcro)
- with adjustable shoulder strap
- capacity for safety spectacles: 12 pcs. (3x4)
- also suitable for safety goggles

uvex carry case	
Art. no.	9954326
Order unit	PC



9957502

uvex SECU box

- storage box for wall mounting
- for spectacles and goggles:
 - 2 safety goggles or
 - 3 safety spectacles or
 - 1 safety goggles and 2 safety spectacles

uvex SECU box	
Art. no.	9957502
Order unit	PC



Accessories

uvex hang-cords · uvex headband



9958017



9959002

uvex eyewear cord

- individual length adjustment
- for compatibility with uvex models please see overview on p. 74

uvex eyewear cord	
Art. no.	9958017
Order quantity multiples	10 PC

uvex eyewear cord

- suitable for all uvex safety spectacles

uvex eyewear cord	
Art. no.	9959002
Order quantity multiples	10 PC

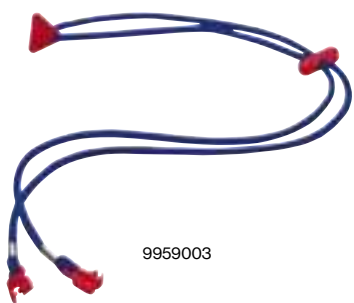

9959003



9959004

uvex eyewear cord

- individual length adjustment
- for compatibility with uvex models please see overview on p. 74

uvex eyewear cord	
Art. no.	9959003
Order quantity multiples	10 PC

uvex eyewear cord

- individual length adjustment
- metal-free
- for compatibility with uvex models please see overview on p. 74

uvex eyewear cord	
Art. no.	9959004
Order quantity multiples	10 PC



9958020



9958023

uvex pheos headband

- headband for uvex pheos and uvex pheos s (see p. 44, 45)
- individual length adjustment
- metal-free















uvex pheos headband	
Art. no.	9958020
Order quantity multiples	10 PC

uvex x-fit / x-fit pro headband

- headband for uvex x-fit und uvex x-fit pro (see p. 38, 39)
- individual length adjustment
- metal-free

uvex x-fit / uvex x-fit pro headband	
Art. no.	9958023
Order quantity multiples	10 PC

Cord/case matrix

Model	Name	Cords/straps							Cases						
															
		9958017	9958020 (pheos/pheos s)	9958009 (i-3/i-3 s)	9959003	9959004	9959002	9958023 (x-fit family)	9954600	9954500	9954501	6118002	9954355	9954360	9957502 SECU-Box
9134	uvex meteor	<input type="checkbox"/>	<input type="checkbox"/>	<input type="checkbox"/>	<input checked="" type="checkbox"/>	<input checked="" type="checkbox"/>	<input checked="" type="checkbox"/>	<input type="checkbox"/>	<input checked="" type="checkbox"/>	<input checked="" type="checkbox"/>	<input checked="" type="checkbox"/>	<input checked="" type="checkbox"/>	<input checked="" type="checkbox"/>	<input checked="" type="checkbox"/>	<input checked="" type="checkbox"/>
9137	uvex ceramic	<input checked="" type="checkbox"/>	<input type="checkbox"/>	<input type="checkbox"/>	<input type="checkbox"/>	<input type="checkbox"/>	<input checked="" type="checkbox"/>	<input type="checkbox"/>	<input checked="" type="checkbox"/>	<input checked="" type="checkbox"/>	<input checked="" type="checkbox"/>	<input checked="" type="checkbox"/>	<input checked="" type="checkbox"/>	<input checked="" type="checkbox"/>	<input checked="" type="checkbox"/>
9143	uvex i-lite	<input checked="" type="checkbox"/>	<input type="checkbox"/>	<input type="checkbox"/>	<input checked="" type="checkbox"/>	<input checked="" type="checkbox"/>	<input checked="" type="checkbox"/>	<input type="checkbox"/>	<input checked="" type="checkbox"/>	<input checked="" type="checkbox"/>	<input checked="" type="checkbox"/>	<input checked="" type="checkbox"/>	<input checked="" type="checkbox"/>	<input checked="" type="checkbox"/>	<input checked="" type="checkbox"/>
9143	uvex i-guard	<input checked="" type="checkbox"/>	<input type="checkbox"/>	<input type="checkbox"/>	<input checked="" type="checkbox"/>	<input checked="" type="checkbox"/>	<input checked="" type="checkbox"/>	<input type="checkbox"/>	<input checked="" type="checkbox"/>	<input checked="" type="checkbox"/>	<input checked="" type="checkbox"/>	<input type="checkbox"/>	<input checked="" type="checkbox"/>	<input checked="" type="checkbox"/>	<input checked="" type="checkbox"/>
9143	uvex i-guard+	<input type="checkbox"/>	<input type="checkbox"/>	<input type="checkbox"/>	<input type="checkbox"/>	<input type="checkbox"/>	<input type="checkbox"/>	<input type="checkbox"/>	<input checked="" type="checkbox"/>	<input checked="" type="checkbox"/>	<input checked="" type="checkbox"/>	<input type="checkbox"/>	<input checked="" type="checkbox"/>	<input checked="" type="checkbox"/>	<input checked="" type="checkbox"/>
9145	uvex pure-fit	<input checked="" type="checkbox"/>	<input type="checkbox"/>	<input type="checkbox"/>	<input type="checkbox"/>	<input type="checkbox"/>	<input checked="" type="checkbox"/>	<input type="checkbox"/>	<input type="checkbox"/>	<input checked="" type="checkbox"/>	<input checked="" type="checkbox"/>	<input checked="" type="checkbox"/>	<input checked="" type="checkbox"/>	<input checked="" type="checkbox"/>	<input checked="" type="checkbox"/>
9155	uvex mercury	<input checked="" type="checkbox"/>	<input type="checkbox"/>	<input type="checkbox"/>	<input type="checkbox"/>	<input type="checkbox"/>	<input checked="" type="checkbox"/>	<input type="checkbox"/>	<input type="checkbox"/>	<input checked="" type="checkbox"/>	<input checked="" type="checkbox"/>	<input checked="" type="checkbox"/>	<input checked="" type="checkbox"/>	<input checked="" type="checkbox"/>	<input checked="" type="checkbox"/>
9159	uvex winner	<input checked="" type="checkbox"/>	<input type="checkbox"/>	<input type="checkbox"/>	<input type="checkbox"/>	<input type="checkbox"/>	<input checked="" type="checkbox"/>	<input type="checkbox"/>	<input checked="" type="checkbox"/>	<input checked="" type="checkbox"/>	<input checked="" type="checkbox"/>	<input checked="" type="checkbox"/>	<input checked="" type="checkbox"/>	<input checked="" type="checkbox"/>	<input checked="" type="checkbox"/>
9160	uvex i-vo	<input type="checkbox"/>	<input type="checkbox"/>	<input type="checkbox"/>	<input checked="" type="checkbox"/>	<input checked="" type="checkbox"/>	<input checked="" type="checkbox"/>	<input type="checkbox"/>	<input checked="" type="checkbox"/>	<input checked="" type="checkbox"/>	<input checked="" type="checkbox"/>	<input checked="" type="checkbox"/>	<input checked="" type="checkbox"/>	<input checked="" type="checkbox"/>	<input checked="" type="checkbox"/>
9161	uvex 9161	<input type="checkbox"/>	<input type="checkbox"/>	<input type="checkbox"/>	<input type="checkbox"/>	<input type="checkbox"/>	<input checked="" type="checkbox"/>	<input type="checkbox"/>	<input type="checkbox"/>	<input checked="" type="checkbox"/>	<input checked="" type="checkbox"/>	<input checked="" type="checkbox"/>	<input checked="" type="checkbox"/>	<input checked="" type="checkbox"/>	<input checked="" type="checkbox"/>
9164	uvex astrospec 2.0	<input checked="" type="checkbox"/>	<input type="checkbox"/>	<input type="checkbox"/>	<input checked="" type="checkbox"/>	<input checked="" type="checkbox"/>	<input checked="" type="checkbox"/>	<input type="checkbox"/>	<input checked="" type="checkbox"/>	<input checked="" type="checkbox"/>	<input checked="" type="checkbox"/>	<input checked="" type="checkbox"/>	<input checked="" type="checkbox"/>	<input checked="" type="checkbox"/>	<input checked="" type="checkbox"/>
9169	uvex super OTG	<input checked="" type="checkbox"/>	<input type="checkbox"/>	<input type="checkbox"/>	<input type="checkbox"/>	<input type="checkbox"/>	<input checked="" type="checkbox"/>	<input type="checkbox"/>	<input type="checkbox"/>	<input checked="" type="checkbox"/>	<input checked="" type="checkbox"/>	<input checked="" type="checkbox"/>	<input checked="" type="checkbox"/>	<input checked="" type="checkbox"/>	<input checked="" type="checkbox"/>
9169	uvex super f OTG	<input checked="" type="checkbox"/>	<input type="checkbox"/>	<input type="checkbox"/>	<input type="checkbox"/>	<input type="checkbox"/>	<input checked="" type="checkbox"/>	<input type="checkbox"/>	<input type="checkbox"/>	<input checked="" type="checkbox"/>	<input checked="" type="checkbox"/>	<input type="checkbox"/>	<input checked="" type="checkbox"/>	<input checked="" type="checkbox"/>	<input checked="" type="checkbox"/>
9172	uvex super g	<input checked="" type="checkbox"/>	<input type="checkbox"/>	<input type="checkbox"/>	<input type="checkbox"/>	<input type="checkbox"/>	<input checked="" type="checkbox"/>	<input type="checkbox"/>	<input checked="" type="checkbox"/>	<input checked="" type="checkbox"/>	<input checked="" type="checkbox"/>	<input checked="" type="checkbox"/>	<input checked="" type="checkbox"/>	<input checked="" type="checkbox"/>	<input checked="" type="checkbox"/>
9175	uvex skyguard NT	<input type="checkbox"/>	<input type="checkbox"/>	<input type="checkbox"/>	<input checked="" type="checkbox"/>	<input checked="" type="checkbox"/>	<input checked="" type="checkbox"/>	<input type="checkbox"/>	<input checked="" type="checkbox"/>	<input checked="" type="checkbox"/>	<input checked="" type="checkbox"/>	<input type="checkbox"/>	<input checked="" type="checkbox"/>	<input checked="" type="checkbox"/>	<input checked="" type="checkbox"/>
9175	uvex skyguard NT (9175275)	<input type="checkbox"/>	<input type="checkbox"/>	<input type="checkbox"/>	<input type="checkbox"/>	<input type="checkbox"/>	<input checked="" type="checkbox"/>	<input type="checkbox"/>	<input checked="" type="checkbox"/>	<input checked="" type="checkbox"/>	<input checked="" type="checkbox"/>	<input type="checkbox"/>	<input checked="" type="checkbox"/>	<input checked="" type="checkbox"/>	<input checked="" type="checkbox"/>
9178	uvex super fit	<input checked="" type="checkbox"/>	<input type="checkbox"/>	<input type="checkbox"/>	<input type="checkbox"/>	<input type="checkbox"/>	<input checked="" type="checkbox"/>	<input type="checkbox"/>	<input checked="" type="checkbox"/>	<input checked="" type="checkbox"/>	<input checked="" type="checkbox"/>	<input checked="" type="checkbox"/>	<input checked="" type="checkbox"/>	<input checked="" type="checkbox"/>	<input checked="" type="checkbox"/>
9180	uvex futura	<input type="checkbox"/>	<input type="checkbox"/>	<input type="checkbox"/>	<input type="checkbox"/>	<input type="checkbox"/>	<input checked="" type="checkbox"/>	<input type="checkbox"/>	<input checked="" type="checkbox"/>	<input checked="" type="checkbox"/>	<input checked="" type="checkbox"/>	<input checked="" type="checkbox"/>	<input checked="" type="checkbox"/>	<input checked="" type="checkbox"/>	<input checked="" type="checkbox"/>
9181	uvex suXceed	<input checked="" type="checkbox"/>	<input type="checkbox"/>	<input type="checkbox"/>	<input type="checkbox"/>	<input type="checkbox"/>	<input checked="" type="checkbox"/>	<input type="checkbox"/>	<input checked="" type="checkbox"/>	<input checked="" type="checkbox"/>	<input checked="" type="checkbox"/>	<input checked="" type="checkbox"/>	<input checked="" type="checkbox"/>	<input checked="" type="checkbox"/>	<input checked="" type="checkbox"/>
9183	uvex i-5	<input checked="" type="checkbox"/>	<input type="checkbox"/>	<input type="checkbox"/>	<input type="checkbox"/>	<input type="checkbox"/>	<input checked="" type="checkbox"/>	<input type="checkbox"/>	<input checked="" type="checkbox"/>	<input checked="" type="checkbox"/>	<input checked="" type="checkbox"/>	<input checked="" type="checkbox"/>	<input checked="" type="checkbox"/>	<input checked="" type="checkbox"/>	<input checked="" type="checkbox"/>
9188	uvex cybric	<input type="checkbox"/>	<input type="checkbox"/>	<input type="checkbox"/>	<input checked="" type="checkbox"/>	<input checked="" type="checkbox"/>	<input checked="" type="checkbox"/>	<input type="checkbox"/>	<input checked="" type="checkbox"/>	<input checked="" type="checkbox"/>	<input checked="" type="checkbox"/>	<input checked="" type="checkbox"/>	<input checked="" type="checkbox"/>	<input checked="" type="checkbox"/>	<input checked="" type="checkbox"/>
9190	uvex i-3 / i-3 s	<input checked="" type="checkbox"/>	<input type="checkbox"/>	<input checked="" type="checkbox"/>	<input type="checkbox"/>	<input type="checkbox"/>	<input checked="" type="checkbox"/>	<input type="checkbox"/>	<input checked="" type="checkbox"/>	<input checked="" type="checkbox"/>	<input checked="" type="checkbox"/>	<input checked="" type="checkbox"/>	<input checked="" type="checkbox"/>	<input checked="" type="checkbox"/>	<input checked="" type="checkbox"/>
9192	uvex pheos / pheos s	<input checked="" type="checkbox"/>	<input checked="" type="checkbox"/>	<input type="checkbox"/>	<input checked="" type="checkbox"/>	<input checked="" type="checkbox"/>	<input checked="" type="checkbox"/>	<input type="checkbox"/>	<input checked="" type="checkbox"/>	<input checked="" type="checkbox"/>	<input checked="" type="checkbox"/>	<input checked="" type="checkbox"/>	<input checked="" type="checkbox"/>	<input checked="" type="checkbox"/>	<input checked="" type="checkbox"/>
9192	uvex pheos guard / s	<input type="checkbox"/>	<input checked="" type="checkbox"/>	<input type="checkbox"/>	<input type="checkbox"/>	<input type="checkbox"/>	<input type="checkbox"/>	<input type="checkbox"/>	<input checked="" type="checkbox"/>	<input checked="" type="checkbox"/>	<input checked="" type="checkbox"/>	<input checked="" type="checkbox"/>	<input checked="" type="checkbox"/>	<input checked="" type="checkbox"/>	<input checked="" type="checkbox"/>
9193	uvex sportstyle	<input checked="" type="checkbox"/>	<input type="checkbox"/>	<input type="checkbox"/>	<input type="checkbox"/>	<input type="checkbox"/>	<input checked="" type="checkbox"/>	<input type="checkbox"/>	<input checked="" type="checkbox"/>	<input checked="" type="checkbox"/>	<input checked="" type="checkbox"/>	<input checked="" type="checkbox"/>	<input checked="" type="checkbox"/>	<input checked="" type="checkbox"/>	<input checked="" type="checkbox"/>
9194	uvex i-works	<input checked="" type="checkbox"/>	<input type="checkbox"/>	<input type="checkbox"/>	<input checked="" type="checkbox"/>	<input checked="" type="checkbox"/>	<input checked="" type="checkbox"/>	<input type="checkbox"/>	<input checked="" type="checkbox"/>	<input checked="" type="checkbox"/>	<input checked="" type="checkbox"/>	<input checked="" type="checkbox"/>	<input checked="" type="checkbox"/>	<input checked="" type="checkbox"/>	<input checked="" type="checkbox"/>
9198	uvex pheos cx2	<input type="checkbox"/>	<input type="checkbox"/>	<input type="checkbox"/>	<input type="checkbox"/>	<input type="checkbox"/>	<input checked="" type="checkbox"/>	<input type="checkbox"/>	<input checked="" type="checkbox"/>	<input checked="" type="checkbox"/>	<input checked="" type="checkbox"/>	<input checked="" type="checkbox"/>	<input checked="" type="checkbox"/>	<input checked="" type="checkbox"/>	<input checked="" type="checkbox"/>
9199	uvex x-fit	<input checked="" type="checkbox"/>	<input type="checkbox"/>	<input type="checkbox"/>	<input type="checkbox"/>	<input checked="" type="checkbox"/>	<input checked="" type="checkbox"/>	<input checked="" type="checkbox"/>	<input checked="" type="checkbox"/>	<input checked="" type="checkbox"/>	<input checked="" type="checkbox"/>	<input checked="" type="checkbox"/>	<input checked="" type="checkbox"/>	<input checked="" type="checkbox"/>	<input checked="" type="checkbox"/>
9199	uvex x-fit pro	<input type="checkbox"/>	<input type="checkbox"/>	<input type="checkbox"/>	<input type="checkbox"/>	<input checked="" type="checkbox"/>	<input checked="" type="checkbox"/>	<input checked="" type="checkbox"/>	<input checked="" type="checkbox"/>	<input checked="" type="checkbox"/>	<input checked="" type="checkbox"/>	<input checked="" type="checkbox"/>	<input checked="" type="checkbox"/>	<input checked="" type="checkbox"/>	<input checked="" type="checkbox"/>
9231	uvex polavision	<input checked="" type="checkbox"/>	<input type="checkbox"/>	<input type="checkbox"/>	<input type="checkbox"/>	<input type="checkbox"/>	<input checked="" type="checkbox"/>	<input type="checkbox"/>	<input checked="" type="checkbox"/>	<input checked="" type="checkbox"/>	<input checked="" type="checkbox"/>	<input checked="" type="checkbox"/>	<input checked="" type="checkbox"/>	<input checked="" type="checkbox"/>	<input checked="" type="checkbox"/>
9301	uvex ultravision	<input type="checkbox"/>	<input type="checkbox"/>	<input type="checkbox"/>	<input type="checkbox"/>	<input type="checkbox"/>	<input type="checkbox"/>	<input type="checkbox"/>	<input type="checkbox"/>	<input type="checkbox"/>	<input checked="" type="checkbox"/>	<input type="checkbox"/>	<input type="checkbox"/>	<input checked="" type="checkbox"/>	<input checked="" type="checkbox"/>
9302	uvex ultrasonic	<input type="checkbox"/>	<input type="checkbox"/>	<input type="checkbox"/>	<input type="checkbox"/>	<input type="checkbox"/>	<input type="checkbox"/>	<input type="checkbox"/>	<input type="checkbox"/>	<input type="checkbox"/>	<input checked="" type="checkbox"/>	<input type="checkbox"/>	<input type="checkbox"/>	<input checked="" type="checkbox"/>	<input checked="" type="checkbox"/>
9305	uvex 9305	<input type="checkbox"/>	<input type="checkbox"/>	<input type="checkbox"/>	<input type="checkbox"/>	<input type="checkbox"/>	<input type="checkbox"/>	<input type="checkbox"/>	<input type="checkbox"/>	<input type="checkbox"/>	<input checked="" type="checkbox"/>	<input type="checkbox"/>	<input type="checkbox"/>	<input checked="" type="checkbox"/>	<input checked="" type="checkbox"/>
9307	uvex carbonvision	<input type="checkbox"/>	<input type="checkbox"/>	<input type="checkbox"/>	<input type="checkbox"/>	<input type="checkbox"/>	<input type="checkbox"/>	<input type="checkbox"/>	<input checked="" type="checkbox"/>	<input checked="" type="checkbox"/>	<input checked="" type="checkbox"/>	<input checked="" type="checkbox"/>	<input checked="" type="checkbox"/>	<input checked="" type="checkbox"/>	<input checked="" type="checkbox"/>
9309	uvex pheos cx2 sonic	<input type="checkbox"/>	<input type="checkbox"/>	<input type="checkbox"/>	<input type="checkbox"/>	<input type="checkbox"/>	<input type="checkbox"/>	<input type="checkbox"/>	<input checked="" type="checkbox"/>	<input checked="" type="checkbox"/>	<input checked="" type="checkbox"/>	<input checked="" type="checkbox"/>	<input checked="" type="checkbox"/>	<input checked="" type="checkbox"/>	<input checked="" type="checkbox"/>
9320	uvex megasonic	<input type="checkbox"/>	<input type="checkbox"/>	<input type="checkbox"/>	<input type="checkbox"/>	<input type="checkbox"/>	<input type="checkbox"/>	<input type="checkbox"/>	<input type="checkbox"/>	<input type="checkbox"/>	<input checked="" type="checkbox"/>	<input type="checkbox"/>	<input type="checkbox"/>	<input checked="" type="checkbox"/>	<input checked="" type="checkbox"/>
9405	uvex 9405	<input type="checkbox"/>	<input type="checkbox"/>	<input type="checkbox"/>	<input type="checkbox"/>	<input type="checkbox"/>	<input type="checkbox"/>	<input type="checkbox"/>	<input type="checkbox"/>	<input type="checkbox"/>	<input checked="" type="checkbox"/>	<input type="checkbox"/>	<input type="checkbox"/>	<input checked="" type="checkbox"/>	<input checked="" type="checkbox"/>

2 goggles or 3-4 spectacles
or 1 goggles + 2 spectacles

compatible not compatible

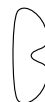

Applications

Always the perfect solution

Working conditions	Eyewear model	Lens material	Lens tint	Lens coating
Light and precision engineering	Spectacles	PC	clear	uvex supravision AR (anti-reflet) uvex supravision excellence
Assembly, maintenance	Spectacles	PC	clear	uvex supravision excellence
Grinding, angle grinding	Spectacles Goggles	PC	clear	uvex supravision excellence uvex supravision extreme
Turning, milling	Spectacles	PC	clear	uvex supravision excellence
Dusty environments	Goggles	PC	clear	uvex supravision excellence uvex supravision extreme
Foundry cleaning	Goggles	PC	clear	uvex supravision excellence uvex supravision extreme
Forestry and agriculture	Spectacles	PC	clear amber grey 23 %	uvex supravision excellence uvex supravision extreme
Laboratory	Spectacles Goggles	PC CA	clear	uvex supravision sapphire uvex supravision excellence
Working with acids and galvanic media	Goggles	PC CA	clear	uvex supravision excellence uvex supravision extreme
Spot welding, soldering oxygene cutting gas welding, braze welding Welders assistant foundries furnaces	Spectacles Goggles	PC	welding shade	uvex infradur uvex infradur plus
Outdoors – sunglare	Spectacles	PC	grey CBR23 silver mirror	uvex supravision excellence uvex supravision extreme
Offshoring / maritime	Spectacles	PC	variomatic polavision	uvex supravision variomatic uvex polavision
Strong lighting, glare	Spectacles	PC	CBR65 silver mirror 53 %	uvex supravision excellence uvex supravision extreme
Mixed lighting	Spectacles	PC	clear	uvex supravision AR (anti-reflet)
Sterile working conditions	Spectacles Overspecs	PC	clear	uvex supravision CR
Oil and gas	Spectacles Overspecs Goggles	PC	clear	uvex supravision plus
Plant visitors	Spectacles Overspecs	PC	clear	uvex supravision excellence uvex supravision sapphire uncoated

Safety Eyewear

Overview

Model	Name	Product	Order quantity multiples/ Order unit	uvex supravision sapphire	uvex supravision plus	uvex supravision excellence	uvex supravision extreme	uvex supravision ETC	uvex supravision clean	uvex supravision AR	Silver mirror, inside anti-fog	uvex supravision variomatic	uvex infradur	uvex infradur plus	CA uncoated	CA anti-fog on the inside	Scratch-resistant on both sides	Scratch-resistant + anti-fog	Uncoated	Page	
9134	uvex meteor	Plastic safety spectacles	5 PC	■															■	54	
9137	uvex ceramic	Metal safety spectacles	5 PC	■																	55
9143	uvex i-lite	Plastic safety spectacles	10 PC			■															31
9143	uvex i-guard	Plastic safety spectacles	8 PC			■															31
9143	uvex i-guard+	Safety goggles	8 PC			■															31
9143	uvex i-range	Replacement lenses	15 PC			■															31
9145	uvex pure-fit	Plastic safety spectacles	75 PC			■														■	33
9155	uvex mercury	Metal safety spectacles	5 PC	■																	55
9159	uvex winner	Metal safety spectacles	5 PC															■	■		55
9160	uvex i-vo	Plastic safety spectacles	10 PC	■	■	■															52
9161	uvex 9161	Plastic safety spectacles	5 PC	■	■															■	56
9164	uvex astrospec 2.0/astrospec 2.0 CB	Plastic safety spectacles	10 PC	■	■	■	■														49
9169	uvex super OTG	Plastic safety spectacles	8 PC	■		■															56
9169	uvex super f OTG	Plastic safety spectacles	8 PC	■		■															57
9169	uvex super f OTG	Plastic safety spectacles	PC									■									57
9169	uvex super f OTG UV525	Plastic safety spectacles	8 PC	■						■											57
9169	uvex super f OTG CR	Plastic safety spectacles	8 PC						■												57
9169	uvex super f OTG	Safety spectacles - welding protection	8 PC											■							70
9172	uvex super g	Plastic safety spectacles	10 PC	■	■	■															50
9172	uvex super g	Replacement lenses	20 PC			■															50
9175	uvex skyguard NT	Plastic safety spectacles	10 PC			■	■														53
9178	uvex super fit	Plastic safety spectacles	10 PC	■	■	■		■													51
9178	uvex super fit CR	Plastic safety spectacles	10 PC						■												51
9178	uvex super fit	Replacement lenses	20 PC			■															51
9180	uvex futura	Plastic safety spectacles	10 PC	■	■																54
9180	uvex futura	Safety spectacles - welding protection	10 PC										■								69
9181	uvex suXxeed	Plastic safety spectacles	10 PC			■															35
9181	uvex suXxeed	Clip-in frame	20 PC																		35
9183	uvex i-5	Plastic safety spectacles	10 PC	■		■		■													37
9183	uvex i-5	Clip-in frame	20 PC																		37
9183	uvex i-5	Safety spectacles - welding protection	10 PC											■							69
9188	uvex cybric	Plastic safety spectacles	10 PC	■	■																54
9190	uvex i-3/uvex i-3s	Plastic safety spectacles	10 PC	■	■	■				■	■										46/47
9190	uvex i-3	Plastic safety spectacles	PC							■		■									46
9190	uvex i-3/uvex i-3s	Clip-in frame	20 PC																		46/47
9192	uvex pheos/uvex pheos CB/uvex pheos s	Plastic safety spectacles	10 PC		■	■	■	■			■										44/45
9192	uvex pheos guard/uvex pheos s guard	uvex pheos headband version	10 PC				■														45
9192	uvex pheos/uvex pheos s	Clip-in frame	20 PC																		44/45
9193	uvex sportstyle	Plastic safety spectacles	10 PC		■	■	■	■		■	■										41
9193	uvex sportstyle	Plastic safety spectacles	PC									■									41
9194	uvex i-works	Plastic safety spectacles	10 PC			■					■										48
9198	uvex pheos cx2	Plastic safety spectacles	10 PC	■		■	■	■			■										42
9199	uvex x-fit	Plastic safety spectacles	10 PC	■		■		■													39
9199	uvex x-fit pro	Plastic safety spectacles	10 PC	■		■															38
9199	uvex x-fit pro (ohne Slider)	Plastic safety spectacles	10 PC			■															38
9199	uvex x-fit/uvex x-fit pro	Clip-in frame	20 PC																		38/39

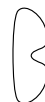

Model	Name	Product	Order quantity multiples/ Order unit	uvex supravision sapphire	uvex supravision plus	uvex supravision excellence	uvex supravision extreme	uvex supravision ETC	uvex supravision clean	uvex supravision AR	Silver mirror, inside anti-fog	uvex supravision variomatic	uvex infraradur	uvex infraradur plus	CA uncoated	CA anti-fog on the inside	Scratch-resistant on both sides	Scratch-resistant + anti-fog	Uncoated	Page
9231	uvex polavision	Plastic safety spectacles	PC																	53
9301	uvex ultravision	Safety goggles	4 PC	■	■											■				64/65
9301	uvex ultravision	Replacement lenses	20/30 PC			■										■				64/65
9300	uvex ultravision	Tear-off films	10 PC																	64/65
9301	uvex ultravision faceguard	Safety goggles	4 PC			■														66
9301	uvex ultravision	Goggles with helmet attachment	4 PC													■				66
9301	uvex ultravision	Mouth shield	PC																■	66
9302	uvex ultrasonic	Safety goggles	4 PC			■	■													63
9302	uvex ultrasonic	Replacement lenses	15 PC			■	■													63
9302	uvex ultrasonic	Goggles with helmet attachment	4 PC				■													63
9302	uvex ultrasonic CR	Safety goggles	4 PC						■											63
9302	uvex ultrasonic flip-up	Safety goggles - welding protection	4 PC			■							■							70
9302	uvex ultrasonic flip-up	Replacement lenses	15 PC										■							70
9305	uvex 9305	Safety goggles	4 PC													■				67
9307	uvex carbonvision	Safety goggles	10 PC				■													67
9309	uvex pheos cx2 sonic	Safety goggles	10 PC				■													60
9320	uvex megasonic	Safety goggles	4 PC			■		■												59
9320	uvex megasonic CR	Safety goggles	4 PC						■											59
9320	uvex megasonic	Replacement lenses	15 PC			■		■												59
9320	uvex megasonic	Headband	4 PC																	59
9320	uvex megasonic	Safety goggles - welding protection	4 PC										■							70
9405	uvex 9405	Safety goggles	4 PC													■				67
6118		eyewear case	10 PC																	72
9972		Microfibre cloth	10 PC																	71
9954		Eyewear case	10 PC																	72
9954		Carry case	PC																	72
9954		Microfibre bag	10 PC																	72
9957		Display	PC																	71
9957		SECU-Box	PC																	72
9958	uvex x-fit/x-fit pro	Comfort Slider	BG (incl. 5 pair)																	39
9958		Neck hang cord	10 PC																	73
9958	uvex pheos/uvex pheos s	Headband	10 PC																	73
9958	uvex x-fit/x-fit pro	Headband	10 PC																	73
9959		Neck hang cord	10 PC																	73
9963		Cleaning towelettes	PC																	71
9970		Cleaning station	PC																	71
9971		Replacement cleaning papers	PC																	71
9972		Cleaning fluid	PC																	71
9973		Plastic pump	PC																	71
9999	uvex x-fit/x-fit pro	uvex LED mini light including adapter (right and left)	PC																	39

laservision

At laservision, as an integral part of uvex, we protect with our products of one of the most sensitive organs - the human eye - from laser radiation. This for 35 years with commitment, customer orientation and innovative strength - worldwide and in accordance with standards. Whether in industry, research and development or in the medical sector, whether as glasses, curtains / roller blinds or partition walls – laservision laser protection products stand for quality, safety and protection - in accordance with the DNA and the claim of the uvex safety group - „protecting people“!

Product portfolio

- Laser protection eyewear made of plastic, glass or with reflective coating
- Patient protection, magnifying glasses, IPL glasses
- Laser protection windows made of glass and plastic
- Active laser protection windows
- Extensive laser protection such as: curtains, blinds, screens, roll-ups
- Laser protection for optical tables

laservision

LASERVISION GmbH & Co. KG
Phone: +49 911 9736-8100
E-Mail: info@lv.com · uvex-laservision.de





Hearing Protection

protecting planet

To help raise awareness of its commitment to achieving increased sustainability, uvex has developed the **protecting planet** icon.

For uvex, **protecting planet** is more than a label. Based on the brand claim, **protecting people**, our sustainable approach integrates three core interlinked pillars – **ecology, economy** and **social responsibility**, that are incorporated throughout the business to improve our sustainability performance.

This explains the comprehensive audit, measurement and evaluation management process uvex undertakes along the entire value chain to ensure its products are as sustainable as possible.



uvex xact-fit planet



The **uvex xact-fit planet** is an example of the **planet series** product system.



protecting planet

by using recycled material //
by maximum reduction of pollutants

100 percent recycled polypropylene (PP) is used for the ergonomically shaped pins of the uvex xact-fit planet. The oval-shaped foam plugs are subject to strict controls and have a maximum reduction of pollutants and harmful substances.



protecting planet

by using environmentally-
friendly packaging

All packaging of the hearing protection product is made of 100 percent recycled cardboard.



protecting planet

by reducing CO₂ emissions

The SwedSafe company, which is part of the uvex Group, leaves only a small carbon footprint. No fossil fuels are used in production and 100 percent of the electricity required comes from renewable sources. To promote biodiversity at the site, natural grasslands/meadow landscapes and additional flowering plants have been created to provide more insect habitats. SwedSafe is certified to ISO 14001 environmental management.

Hearing Protection

All ears when it comes to safety

Noise-induced hearing loss is still one of the most common occupational hazards of all.

It develops painlessly, is progressive and generally goes unnoticed. It is the fact that it's irreversible which makes it so serious. The risk to hearing and the importance of hearing protection are often recognised too late.

What is noise?

Loud sounds which comprise noise not only pose a risk to hearing but can also be distracting and debilitating.

Persistent low-grade sounds such as a clock ticking or a dripping tap can also affect concentration levels.

Adverse health effects caused by harmful noise levels

Listed below are the maximum periods of time a person should be exposed to harmful noise per day without wearing hearing protection.

85 dB	8 hours	103 dB	7.5 minutes
88 dB	4 hours	106 dB	4 minutes
91 dB	2 hours	109 dB	2 minutes
94 dB	1 hour	112 dB	1 minute
97 dB	30 minutes	115 dB	30 seconds
100 dB	15 minutes		



Only those who suffer from hearing loss really understand just how essential a good sense of hearing is and that protecting it should be a top priority.

What are the consequences of noise?

We use our hearing continuously, it never gets a break and cannot be "switched off". We are exposed to noise every day, all day, from multiple sources so our hearing is under constant stress.

These daily demands on our ears can lead to irreversible noise-induced hearing loss. But, it's not just our hearing that is affected; noise means stress for the entire body. Noise affects us subconsciously and can lead to difficulty concentrating, gastrointestinal illness, elevated blood pressure and increased risk of a heart attack.





Tests and standards

All uvex hearing protection products comply with the requirements of current EU legislation, including the PPE regulation (EU) 2016/425, which ensures CE conformity. The products have been tested in accordance with the applicable European standards and additional international standards. As category III products, they are subject to Module D inspections by a notified body, as indicated by the code printed on the product after the CE mark.

Continuous quality assurance with ISO 9001/2015, I ISO 14001:2015 ISO 45001.

Applicable DIN EN norms are:

- EN 352: Part 1 Earmuffs
- EN 352: Part 2 Ear plugs
- EN 352: Part 3 Earmuffs attached to a safety helmet
- EN 352: Part 4 Level-dependent hearing protection earmuffs
- EN 352: Part 6 Earmuffs with communication equipment
- EN 352: Part 8 Audio earmuffs for entertainment

Abbreviations for protection values with explanations

SNR	Single Number Rating/average protection capacity
f/Hz	Frequency given as a unit of Hertz
(MA) Mean Attenuation	Mean attenuation
(SD)	Standard Deviation
(APV) Assumed Protection Value	Assumed protection value
HML value	H: Attenuation value at high frequencies
	M: Attenuation value at medium frequencies
	L: Attenuation value at low frequencies

Hearing protection

Size and fit

Everyone's ear canal is unique – much like a fingerprint. Which is why it's all the more important that you choose adequate and suitable hearing protection that is the correct size to achieve a good fit. uvex offers a complete range of hearing protection to ensure all wearers are able to achieve a fit that's right for them.

Choosing the wrong size can severely reduce the protection value, exposing wearers to harmful noise, and makes the ear plugs uncomfortable to wear.

- if the earplugs are too large, they are unlikely to sit deep enough in the ear canal, so the specified protection level cannot be achieved. They'll also feel uncomfortable
- if the earplugs are too small, although they may be comfortable to wear, there could be noise leakage and reduced protection capacity which over time can cause noise-induced hearing loss.
- round earplugs don't necessarily completely seal an oval-shaped ear canal. It is on this premise that we developed the uvex xact-fit range of hearing protectors.

It is best to try different sizes to find the one that gives you the best protection and fit. With the uvex com4-fit and uvex x-fit, we offer something for the majority of ear canal shapes.



Look out for the different sizes



The cross-section of an ear canal is oval shaped

Anyone can get used to wearing hearing protection; you just need to choose the right type of protection for you.

- wearing time
- noise levels
- choose earplugs according to the size of your ear canal
- earmuffs are not recommended for hot workplaces
- fitting accuracy (glasses wearers)
- for earmuff wearers, the weight should be taken into consideration
- handling (dirty hands, gloves, disabilities)
- compatibility with other PPE (helmet, glasses, respiratory protection)

The right hearing protection can make even the loudest noises more comfortable.

Hearing Protection

Different situations, different ears



A unique design, even inside the earplugs

uvex xtra-fit			<ul style="list-style-type: none"> • intricate recess design for long-term wearer comfort • designed to minimise pressure in the ear canal • grip section for easy insertion and removal
uvex x-fit			
uvex com4-fit			
uvex hi-com			<p>Defined protection zone for controlled noise reduction, resulting in excellent speech and signal recognition and good communication</p>
uvex xact-fit			

Hearing protection for every situation

There are many types of uvex hearing protection which are suitable for different situations and if you work in or are passing through high noise level areas you need the right level of protection.

It is important to strike the right balance between the need to adequately protect your hearing from dangerous noise while not compromising your ability to hear and communicate.

The below chart gives you an overview of which uvex hearing protection may be suitable based on the noise level.



Hearing protection

The uvex xact-fit family

Using earplugs has never been easier



Easy, fast and accurate insertion

Medium protection capacity for excellent speech and signal recognition for easy communication

Replacement earplugs are available, for a cost-effective and environmentally conscious choice

No rolling required, so they can be used with dirty hands or while wearing gloves

Ergonomically shaped stems make fitting easy, hygienic, accurate and achieves a high level of wearer comfort

Thumb indentations with left and right marking ensures correct insertion and easy fitting

The shape means it fits most ear canals securely and comfortably

The uvex xact-fit family



uvex xact-fit

Catalogue page 92



uvex xact-fit detec

Catalogue page 94



uvex xact-fit multi reusable

Catalogue page 92



uvex xact-band

Catalogue page 96

Hearing protection

The uvex xact-fit family



uvex xact-fit – intelligent ergonomics

A new dimension of wearer comfort



The cross-section of an ear canal is oval shaped

The stem is ergonomically shaped to fit either the left or right ear to increase wearer comfort and make the earplugs easier to insert and remove.

The design is easily identifiable from a distance, making it easier to monitor usage in accordance with your company's regulations.

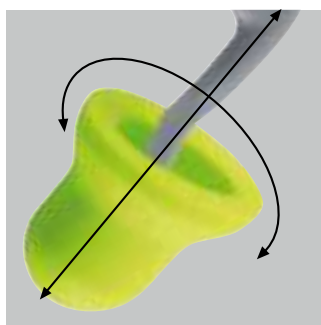

Perfect fit

Oval-shaped foam earplugs mimic the natural shape of the ear canal for low pressure fit and enhanced comfort

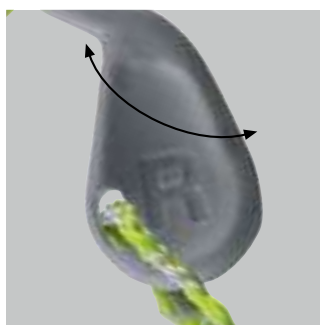

Ergonomic thumb indentations

The ergonomic thumb indentations with left and right marking ensures correct insertion and easy fitting

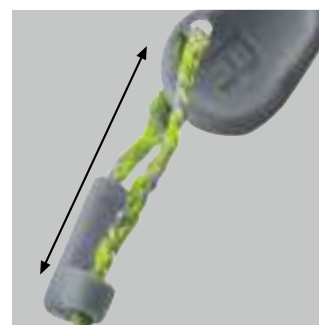

Adjustable cord

Hearing Protection

Disposable ear plugs

uvex hi-com

A unique design – even on the inside

Patented

Designed to minimise pressure in the ear canal

Reduced risk of over protection and feelings of isolation

Intricate recess design for long-term wearer comfort

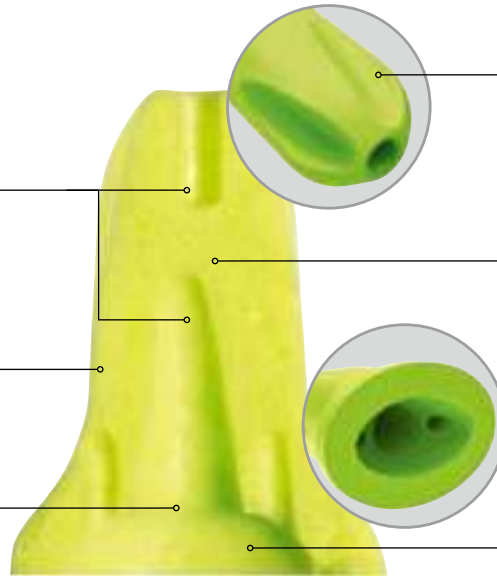

Large surface area delivers softer acoustics and absorbs inner ear sounds which can become obvious when wearing hearing protection in quieter areas

Defined protection zone for controlled noise reduction, resulting in excellent speech and signal recognition and good communication

Grip recess for easy removal



2112100
2112095



2112106



2112095
Table-top dispenser box



2112101

uvex hi-com

- delivers low, flat attenuation allowing for excellent speech and sound recognition
- large surface area delivers softer acoustics and absorbs inner ear sounds which can become obvious when wearing hearing protection in quieter areas
- available in two colours

uvex hi-com		
Art. no.	2112100	2112101
Design	without cord	with cord
Standard	EN 352-2:2020	EN 352-2:2020
Colour	lime	lime
Order unit	CT	CT
Content	200 PR, packed in pairs in CT	100 PR, packed in pairs in CT

uvex hi-com		
Art. no.	2112095	2112106
Design	without cord	without cord
Standard	EN 352-2:2020	EN 352-2:2020
Colour	lime	beige
Order unit	CT	CT
Content	100 PR, packed in pairs in CT	200 PR, packed in pairs in CT

f/Hz	125	250	500	1000	2000	4000	8000	SNR	26 dB H	30 dB M	33 dB L	18 dB
MA dB	17,6	19,0	25,4	29,6	34,5	39,0	43,8	SNRm	30,1 dB Hm	34,4 dB Mm	27,3 dB Lm	21,9 dB
SD dB	4,2	3,7	5,0	5,2	3,8	5,5	4,1	SNRs	3,7 dB Hs	3,9 dB Ms	3,9 dB Ls	3,7 dB
APV dB	13,5	15,3	20,3	24,5	30,6	33,5	39,6					

Refill boxes for uvex "one2click" dispenser on page 90

MADE IN SWEDEN

Hearing Protection

Disposable ear plugs



2112012



2112004
2112096
2112131

uvex com4-fit

- disposable earplugs with a compact, ergonomic design
- perfect for narrow and smaller ear canals
- suitable for use in high noise environments
- patented x-grip technology reduces pressure on the ear canal and aids easy, hygienic removal
- increased wearing comfort, when worn for extended periods

uvex com4-fit				
Art. no.	2112004	2112096	2112131	2112012
Design	without cord	without cord	without cord	with cord
Standard	EN 352-2:2020	EN 352-2:2020	EN 352-2:2020	EN 352-2:2020
Colour	light orange	light orange	light orange	light orange
Order unit	CT	CT	CT	CT
Content	200 PR, packed in pairs in CT	100 PR, packed in pairs in CT	15 PR, loose in CT	100 PR, packed in pairs in CT

f/Hz	63	125	250	500	1000	2000	4000	8000	SNR	33 dB H	34 dB M	31 dB L	29 dB
MA dB	28.9	31.0	33.6	33.8	33.6	36.2	40.6	44.3	SNRm	36.3 dB Hm	36.6 dB Mm	33.9 dB Lm	33.1 dB
SD dB	3.4	5.2	5.4	5.4	4.0	4.2	3.7	2.9	SNRs	2.9 dB Hs	2.8 dB Ms	3.3 dB Ls	4.2 dB
APV dB	25.5	25.8	28.2	28.4	29.6	32.0	36.9	41.4					

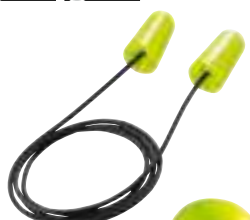

2112010



2112001
2112094
2112133

uvex x-fit

- tapered plug shape ensures natural, pressure free fit – maximising comfort and protection levels
- suitable for use in high noise environments
- patented x-grip technology reduces pressure on the ear canal and aids easy, hygienic removal

uvex x-fit					
Art. no.	2112001	2112094	2112013	2112133	2112010
Design	without cord	without cord	without cord	without cord	with cord
Standard	EN 352-2:2020	EN 352-2:2020	EN 352-2:2020	EN 352-2:2020	EN 352-2:2020
Colour	lime	lime	lime	lime	lime
Order unit	CT	CT	CT	CT	CT
Content	200 PR, packed in pairs in CT	100 PR, packed in pairs in CT	50 PR, loose in CT	15 PR, loose in CT	100 PR, packed in pairs in CT

f/Hz	63	125	250	500	1000	2000	4000	8000	SNR	37 dB H	36 dB M	35 dB L	34 dB
MA dB	35.3	38.4	39.3	40.8	38.9	37.8	45.9	45.1	SNRm	40.0 dB Hm	39.1 dB Mm	38.1 dB Lm	38.0 dB
SD dB	4.2	6.3	5.3	5.5	5.5	4.3	3.9	4.6	SNRs	2.8 dB Hs	3.1 dB Ms	3.2 dB Ls	3.6 dB
APV dB	31.1	32.1	34.0	35.3	33.4	33.5	42.0	40.5					



2112060
2112093

uvex xtra-fit

- disposable earplugs ideal for larger ear canals
- adapts to the shape and size of the ear canal, thereby optimising fit and protection
- very soft and comfortable to wear

uvex xtra-fit	
Art. no.	2112060
Design	without cord
Standard	EN 352-2:2020
Colour	orange
Order unit	BG
Content	200 PR, packed in pairs in BG

f/Hz	63	125	250	500	1000	2000	4000	8000	SNR	35 dB H	34 dB M	33 dB L	32 dB
MA dB	32.7	34.8	36.8	38.9	36.9	36.2	44.0	41.5	SNRm	38.1 dB Hm	37.1 dB Mm	36.5 dB Lm	36.4 dB
SD dB	4.6	4.4	5.6	5.2	4.7	3.7	4.0	5.0	SNRs	2.9 dB Hs	2.7 dB Ms	3.2 dB Ls	3.9 dB
APV dB	28.1	30.4	31.2	33.7	32.2	32.5	40.0	36.5					

Hearing Protection

Disposable ear plugs · Earplug dispenser · Refill packs



2112000
2111988

2111989



2111990

2111991

2111992

uvex dispenser “one2click”

- easy-to-use and robust hearing protection dispenser with two different mounting options
- earplugs available to hand with just one click
- ensures hygienic dispensing whenever it's needed
- magnetic wall mount requires no drilling
- can be refilled even if the container is not empty
- collecting tray prevents earplugs from falling on the floor
- suitable for all uvex disposable earplugs
- quantities: 600 pairs (extra-fit 500 pairs)
- magnetic variant for flexible use on all magnetic surfaces (2112988)
- stationary wall mounting using screws (2112000)
- magnetic wall mount can be retrofitted individually (2112989)

uvex dispenser "one2click"

Art. no.	2112000	2111988
Mounting	empty, screw mounting	empty, magnetic mounting
Order unit	CT	CT

uvex magnetic bracket for dispenser

Art. no.	2111989
Mounting	retrofit kit for dispenser for magnetic mounting
Material	polished steel
Order unit	CT

uvex dispenser "one2click"

Art. no.	2111990	2111991	2111992
Type	ready to use (filled), screw mounting	ready to use (filled), screw mounting	ready to use (filled), screw mounting
	600 pairs of x-fit	600 pairs of com4-fit	600 pairs of hi-com
Order unit	CT	CT	CT

► For the ready-to-use magnetic version, the magnetic plate (2112989) must be ordered separately

uvex dispenser “one2click” – Refill packs



	uvex x-fit	uvex com4-fit	uvex xact-fit
Art. no.	2112022	2112023	2124003
Design	without cord	without cord	replacement earplugs
Standard	EN 352-2:2020	EN 352-2:2020	EN 352-2:2020
	additional requirement: S, V, W, E,	additional requirement: S, V, W, E,	additional requirement: W
SNR	37 dB (see page 89)	33 dB (see page 87)	26 dB (see page 90)
Colour	lime	light orange	lime
Size	M	S	M
Order unit	CT	CT	CT
Content	300 PR, loose in CT	300 PR, loose in CT	400 PR, loose in CT

	uvex hi-com	uvex hi-com	uvex xtra-fit
Art. no.	2112118	2112119	2112061
Design	without cord	without cord	without cord
Standard	EN 352-2:2020	EN 352-2:2020	EN 352-2:2020
	additional requirement: W	additional requirement: W	additional requirement: S, V, W, E,
SNR	26 dB (see page 86)	26 dB (see page 86)	35 dB (see page 87)
Colour	lime	beige	orange
Size	M	M	L
Order unit	CT	CT	BG
Content	300 PR, loose in CT	300 PR, loose in CT	250 PR, loose in BG

Sustainable uvex packaging

Wood exterior – sugar cane interior

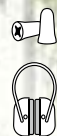

The uvex hearing protection earplugs packaging material is made from renewable raw materials:

The kraft paper is made from wood and the LD polyethylene coating on the interior is made from sugar cane. This means the packaging can be completely recycled.

- **Now made of kraft paper instead of plastic**
- **Completely recyclable**
- **Sustainable raw materials**
- **Optimised for energy recovery**



The material complies with the applicable requirements of the EU Directive 94/62/EC and 2004/12/EC on packaging materials/packaging waste.



2112087

MADE IN SWEDEN

uvex x-fit

- tapered plug shape ensures natural, pressure free fit – maximising comfort and protection levels
- suitable for use in high noise environments
- patented x-grip technology reduces pressure on the ear canal and aids easy, hygienic removal

uvex x-fit	
Art. no.	2112087
Design	without cord
Standard	EN 352-2:2020
Colour	lime
Order unit	CT
Content	100 PR, packed in pairs in CT

SNR: 37 dB H: 36 dB M: 35 dB L: 34 dB

Details on page 88

Hearing Protection

Disposable earplugs · Reusable earplugs · uvex xact-fit



2124001



2124002



2124026

minibox

uvex xact-fit planet

- ergonomically shaped pins made from 100% recycled material
- left/right pod carriers simplify fitting and ensure accurate fit everytime
- tapered plug shape ensures natural, pressure free fit – maximizing comfort and protections level
- adjustable neck cord can be altered to wearers for increased safety
- all packaging is made of recycled cardboard

uvex xact-fit planet		uvex xact-fit planet replacement earplugs	
Art. no.	2124001	2124026	2124002
Design	with reusable pin, in minibox	with reusable pin in earplug box	replacement earplugs, in minibox
Standard	EN 352-2:2020	EN 352-2:2020	EN 352-2:2020
Colour	lime	lime	lime
Order unit	CT	CT	CT
Content	50 PR, packed in pairs in CT	50 PR, packed in pairs in CT	250 PR, CT of 5 pairs

f/Hz	63	125	250	500	1000	2000	4000	8000	SNR	26 dB H	28 dB M	23 dB L	20 dB
MA dB	16.6	19.4	22.0	25.6	27.5	31.8	34.4	36.9	SNRm	29.7 dB Hm	31.3 dB Mm	27.2 dB Lm	23.9 dB
SD dB	5.4	4.9	4.2	4.9	4.7	3.8	4.4	6.0	SNRs	3.6 dB Hs	3.2 dB Ms	3.9 dB Ls	4.0 dB
APV dB	11.2	14.5	17.8	20.7	22.8	28.0	30.0	30.9					



2124019



2124017

uvex xact-fit multi reusable

- Reusable earplugs with thumb indentations
- oval-shaped earplugs mimics the natural shape of the ear canal for optimum fit and comfort
- interchangeable replacement earplugs
- can be handled with dirty hands or while wearing gloves
- available in two sizes

uvex xact-fit multi reusable S		uvex xact-fit multi reusable M/L	
Art. no.	2124019	2124020	2124017
Design	with oval-shaped reusable earplugs, in minibox	with oval-shaped reusable earplugs, in minibox	with oval-shaped reusable earplugs, in earplug box
Standard	EN 352-2:2020	EN 352-2:2020	EN 352-2:2020
Colour	grey, transparent	grey, transparent	grey, transparent
Size	S	S	S
Order unit	CT	CT	CT
Content	50 PR, packed in pairs in CT	50 PR, packed in pairs in CT	50 PR, packed in pairs in CT



2124020



2124018

uvex xact-fit multi reusable M/L		uvex xact-fit multi reusable S	
Art. no.	2124020	2124017	2124019
Design	with oval-shaped reusable earplugs, in minibox	with oval-shaped reusable earplugs, in minibox	with oval-shaped reusable earplugs, in earplug box
Standard	EN 352-2:2020	EN 352-2:2020	EN 352-2:2020
Colour	grey, transparent	grey, transparent	grey, transparent
Size	M/L	M/L	S
Order unit	CT	CT	CT
Content	50 PR, packed in pairs in CT	50 PR, packed in pairs in CT	50 PR, packed in pairs in CT

f/Hz	125	250	500	1000	2000	4000	8000	SNR	26 dB H	26 dB M	24 dB L	22 dB
MA dB	26.9	25.4	26.1	28.3	31.9	32.8	37.2	SNRm	29.6 dB Hm	30.6 dB Mm	27.5 dB Lm	26.3 dB
SD dB	4.4	4.5	5.4	5.5	4	6.9	6.7	SNRs	3.7 dB Hs	4.4 dB Ms	3.8 dB Ls	3.9 dB
APV dB	22.5	20.9	20.7	22.8	27.9	25.9	30.5					

Hearing Protection

Reusable ear plugs



minibox
2111201



2111237

uvex whisper

- easy-to-clean reusable corded earplugs
- smooth, dirt-repellent surface can be easily cleaned using soap and water
- earplug box for hygienic storage when not in use
- with the cord, the earplugs are conveniently to hand – in low-noise areas, the earplugs can be worn comfortably around the neck

uvex whisper	
Art. no.	2111201 2111237
Design	with cord, in minibox with cord, in earplug box
Standard	EN 352-2:2020 EN 352-2:2020
Colour	orange orange
Order unit	CT CT
Content	50 PR, in pairs in CT 50 PR, in pairs in CT

f/Hz	63	125	250	500	1000	2000	4000	8000	SNR	22 dB H	23 dB M	19 dB L	17 dB
MA dB	23.7	23.2	21.1	22.6	24.8	31.7	33.4	39.4	SNRm	27.1 dB Hm	29.6 dB Mm	24.3 dB Lm	22.4 dB
SD dB	5.6	5.8	6.8	5.2	5.7	6.0	9.5	8.2	SNRs	5.6 dB Hs	6.3 dB Ms	5.2 dB Ls	5.7 dB
APV dB	18.1	17.4	14.3	17.4	19.1	25.7	23.9	31.2					

uvex whisper +

- easy-to-clean reusable corded earplugs
- smooth, dirt-repellent surface can be easily cleaned using soap and water
- earplug box for hygienic storage when not in use
- with the cord, the earplugs are conveniently to hand – in low-noise areas, the earplugs can be worn comfortably around the neck



minibox
2111212



2111238

uvex whisper +	
Art. no.	2111212 2111238
Design	with cord, in minibox with cord, in earplug box
Standard	EN 352-2:2020 EN 352-2:2020
Colour	lime lime
Order unit	CT CT
Content	50 PR, in pairs in CT 50 PR, in pairs in CT

f/Hz	63	125	250	500	1000	2000	4000	8000	SNR	27 dB H	27 dB M	24 dB L	22 dB
MA dB	26.6	26.9	24.3	26.1	28.8	32.8	32.6	38.1	SNRm	30.3 dB Hm	31.4 dB Mm	28.0 dB Lm	26.0 dB
SD dB	6.1	6.1	4.1	5.1	5.1	5.0	6.5	5.3	SNRs	3.8 dB Hs	4.0 dB Ms	4.1 dB Ls	4.0 dB
APV dB	20.5	20.8	20.2	21.0	23.7	27.8	26.1	32.8					

uvex whisper supreme

- easy-to-clean reusable corded earplugs
- smooth, dirt-repellent surface can be easily cleaned using soap and water
- earplug box for hygienic storage when not in use
- with the cord, the earplugs are conveniently to hand – in low-noise areas, the earplugs can be worn comfortably around the neck



2111235

uvex whisper supreme	
Art. no.	2111235
Design	with cord, in earplug box
Standard	EN 352-2:2020
Colour	yellow
Order unit	CT
Content	50 PR, in pairs in CT

f/Hz	125	250	500	1000	2000	4000	8000	SNR	30 dB H	31 dB M	27 dB L	27 dB
MA dB	33.8	29.2	32.7	30.0	36.0	34.3	41.0	SNRm	33.4 dB Hm	33.9 dB Mm	31.0 dB Lm	30.4 dB
SD dB	5.1	4.6	4.9	5.0	4.0	3.6	4.4	SNRs	2.9 dB Hs	2.7 dB Ms	3.6 dB Ls	3.6 dB
APV dB	28.7	24.5	27.8	25.0	32.0	30.6	36.6					

Hearing Protection

Detectable ear plugs



211214



2112011



2124011



2124013



minibox

uvex hi-com detec

- metal powder in cord allows full detection even if the cord is shredded, coloured blue for easy recognition
- oval pods match the shape of the outer ear ensuring pressure free, comfortable fit
- delivers low, flat attenuation allowing for excellent speech and sound recognition
- large surface area delivers softer acoustics and absorbs inner ear sounds which can become obvious when wearing hearing protection in quieter areas

uvex hi-com detec												
Art. no.	211214											
Design	with cord, detectable											
Standard	EN 352-2:2020											
Colour	blue											
Order unit	CT											
Content	100 PR, in pairs in CT											

f/Hz	125	250	500	1000	2000	4000	8000	SNR	26 dB H	30 dB M	23 dB L	18 dB
MA dB	17.6	19.0	25.4	29.6	34.5	39	43.8	SNRm	30.1 dB Hm	34.4 dB Mm	27.3 dB Lm	21.9 dB
SD dB	4.2	3.7	5.0	5.2	3.8	5.5	4.1	SNRs	3.7 dB Hs	3.9 dB Ms	3.9 dB Ls	3.7 dB
APV dB	13.5	15.3	20.3	24.5	30.6	33.5	39.6					

uvex x-fit detec

- disposable earplugs coloured blue with metal component for easy detection
- suitable for use in high noise environments
- tapered shape matches the ear canal anatomy for comfortable and secure fit
- patented x-grip technology reduces pressure on the ear canal and aids easy, hygienic removal
- sealed PU foam reduces the potential for contamination

uvex x-fit detec												
Art. no.	2112011											
Design	with cord, detectable											
Standard	EN 352-2:2020											
Colour	blue											
Order unit	CT											
Content	100 PR, in pairs in CT											

f/Hz	63	125	250	500	1000	2000	4000	8000	SNR	37 dB H	36 dB M	35 dB L	34 dB
MA dB	35.3	38.4	39.3	40.8	38.9	37.8	45.9	45.1	SNRm	40.0 dB Hm	39.1 dB Mm	38.1 dB Lm	38.0 dB
SD dB	4.2	6.3	5.3	5.5	5.5	4.3	3.9	4.6	SNRs	2.8 dB Hs	3.1 dB Ms	3.2 dB Ls	3.6 dB
APV dB	31.1	32.1	34.0	35.3	33.4	33.5	42.0	40.5					

uvex xact-fit detec

- disposable plugs with integrated metal elements makes both earplugs and cord detectable
- tapered plug shape ensures natural, pressure free fit – maximising comfort and protection levels
- left / right pod carriers simplify fitting and ensure accurate fit every-time
- adjustable neck cord can be altered to wearers requirements
- sealed PU foam reduces the potential for contamination for increased hygiene
- replacement pods prolong the life of the product

uvex xact-fit detec												
Art. no.	2124011						2124013					
Design	with reusable pin, detectable						replacement earplugs					
Standard	EN 352-2:2020						EN 352-2:2020					
Colour	blue						blue					
Order unit	CT						CT					
Content	50 PR, in pairs in CT						400 PR, loose in CT					

f/Hz	63	125	250	500	1000	2000	4000	8000	SNR	26 dB H	28 dB M	23 dB L	20 dB
MA dB	16.6	19.4	22.0	25.6	27.5	31.8	34.4	36.9	SNRm	29.7 dB Hm	31.3 dB Mm	27.2 dB Lm	23.9 dB
SD dB	5.4	4.9	4.2	4.9	4.7	3.8	4.4	6.0	SNRs	3.6 dB Hs	3.2 dB Ms	3.9 dB Ls	4.0 dB
APV dB	11.2	14.5	17.8	20.7	22.8	28.0	30.0	30.9					

Hearing Protection

Detectable ear plugs



SNR ^{dB}
22



minibox
2111261

2111262

uvex whisper detec

- easy-to-clean reusable corded earplugs
- smooth, dirt-repellent surface can be easily cleaned using mild soap and water
- earplug box for hygienic storage when not in use
- integrated metal parts and the blue colour ensure the earplugs can be detected in a production environment
- thanks to the cord, the earplugs are always conveniently to hand – in low-noise areas, the earplugs can be worn around the neck

uvex whisper detec

Art. no.	2111261	2111262
Design	with cord detectable, in minibox	with cord detectable, in earplug box
Standard	EN 352-2:2020	EN 352-2:2020
Colour	blue	blue
Order unit	CT	CT
Content	50 PR, in pairs in CT	50 PR, in pairs in CT

f/Hz	63	125	250	500	1000	2000	4000	8000	SNR	22 dB H	23 dB M	19 dB L	17 dB
MA dB	23.7	23.2	21.1	22.6	24.8	31.7	33.4	39.4	SNRm	27.1 dB Hm	29.6 dB Mm	24.3 dB Lm	22.4 dB
SD dB	5.6	5.8	6.8	5.2	5.7	6.0	9.5	8.2	SNRs	5.6 dB Hs	6.3 dB Ms	5.2 dB Ls	5.7 dB
APV dB	18.1	17.4	14.3	17.4	19.1	25.7	23.9	31.2					

SNR ^{dB}
27



minibox
2111260

2111239

uvex whisper+ detec

- easy-to-clean reusable corded earplugs
- smooth, dirt-repellent surface can be easily cleaned using mild soap and water
- earplug box for hygienic storage when not in use
- integrated metal parts and the blue colour ensure the earplugs can be detected in a production environment
- thanks to the cord, the earplugs are always conveniently to hand – in low-noise areas, the earplugs can be worn around the neck

uvex whisper+ detec

Art. no.	2111260	2111239
Design	with cord detectable, in minibox	with cord detectable, in earplug box
Standard	EN 352-2:2020	EN 352-2:2020
Colour	blue	blue
Order unit	CT	CT
Content	50 PR, in pairs in CT	50 PR, in pairs in CT

f/Hz	63	125	250	500	1000	2000	4000	8000	SNR	27 dB H	27 dB M	24 dB L	22 dB
MA dB	26.6	26.9	24.3	26.1	28.8	32.8	32.6	38.1	SNRm	30.3 dB Hm	31.4 dB Mm	28.0 dB Lm	26.0 dB
SD dB	6.1	6.1	4.1	5.1	5.1	5.0	6.5	5.3	SNRs	3.8 dB Hs	4.0 dB Ms	4.1 dB Ls	4.0 dB
APV dB	20.5	20.8	20.2	21.0	23.7	27.8	26.1	32.8					

MADE IN SWEDEN

Hearing Protection

Banded hearing protection



2125361

2125351

uvex x-cap

- ergonomically shaped banded ear protector for optimal positioning in front of the chin
- ergonomically shaped earplugs provide a high level of wearer comfort
- replaceable earplugs
- seal forms at the opening of the ear canal meaning there is no pressure in the ear

uvex x-cap			
Art. no.	2125361	2125351	
Design	with band	replacement earplugs	
Standard	EN 352-2:2020		
Colour	grey, sky blue, lime	sky blue, lime	
Order unit	CT	CT	
Content	15 PC, individually packed in CT	60 PR, CT of 5 pairs	

f/Hz	63	125	250	500	1000	2000	4000	8000	SNR	23 dB H	27 dB M	20 dB L	18 dB
MA dB	23.7	22.0	21.6	19.0	23.8	31.9	39.6	39.6	SNRm	26.7 dB Hm	30.4 dB Mm	23.1 dB Lm	21.4 dB
SD dB	4.0	2.9	4.7	4.3	3.6	4.0	2.7	3.7	SNRs	3.4 dB Hs	3.0 dB Ms	3.5 dB Ls	3.8 dB
APV dB	19.7	19.1	16.9	14.7	20.2	27.9	36.9	35.9					



2125344

uvex x-fold

- ergonomically shaped banded ear protector for optimal positioning in front of the chin which eliminates noise transfer on contact
- ergonomically shaped replacement earplugs for optimal wearer comfort
- foldable banded ear protectors make storage easy

uvex x-fold			
Art. no.	2125344	2125351	
Design	with foldable band	replacement earplugs	
Standard	EN 352-2:2020		
Colour	grey, sky blue, lime	sky blue, lime	
Order unit	CT	CT	
Content	5 PC, individually packed in CT	60 PR, CT of 5 pairs	

f/Hz	125	250	500	1000	2000	4000	8000	SNR	26 dB H	30 dB M	23 dB L	21 dB
MA dB	27.1	23.0	24.1	26.2	35.1	39.6	40.4	SNRm	30.1 dB Hm	33.1 dB Mm	26.7 dB Lm	24.7 dB
SD dB	5.1	4.2	4.3	4.2	3.1	3.4	4.4	SNRs	3.6 dB Hs	3.0 dB Ms	3.8 dB Ls	3.8 dB
APV dB	22.0	18.8	19.8	22.0	31.9	36.2	36.0					



2125372

2124002
2124003

uvex xact-band

- extremely low weight – just 4 grams
- seal forms inside the ear canal, just like disposable plugs
- integrated sound absorbers reduce noise transmission through the band
- replacement earplugs can be dispensed through the standard uvex wall mounted dispenser unit
- banded ear protector
- thumb indentations on the stems for quick and easy fitting

uvex xact-band				
Art. no.	2125372	2124002	2124003	
Design	with band	replacement earplugs	replacement earplugs	
Standard	EN 352-2:2020			
Colour	grey, sky-blue, lime	lime	lime	
Order unit	CT	CT	CT	
Content	5 PC, individually packed in CT	250 PR, CT of 5 pairs	400 PR, loose in CT	

f/Hz	63	125	250	500	1000	2000	4000	8000	SNR	26 dB H	29 dB M	22 dB L	21 dB
MA dB	21.5	23.3	24.7	25.3	27.1	33.0	37.3	38.5	SNRm	30.4 dB Hm	32.4 dB Mm	27.4 dB Lm	25.5 dB
SD dB	3.6	3.6	4.7	6.0	5.5	2.7	4.3	4.9	SNRs	4.5 dB Hs	3.6 dB Ms	5.1 dB Ls	4.6 dB
APV dB	17.9	19.7	20.0	19.3	21.5	30.3	33.0	33.6					



Earmuffs

uvex aXess one

safe. active. connected.



RAL – real active listening

Active listening function with the ability to individually adjust the volume of ambient noise. Safe application thanks to integrated sound level limiter.

Bluetooth® 5.2

Good sound quality, fast data transfer and a large range with optimised energy consumption.

Dual connection mode

The hearing protection can be paired with two Bluetooth devices at the same time.

Certified hearing protection

Attenuation value with SNR 31 dB

Audio streaming

Ideal for monotonous work.

Two surround-sound microphones

For reliable transmission of ambient noise.

Voice microphone

Ensures optimal voice quality.

Status messages

The audio assistant provides you information through voice prompts ("Bluetooth connected"), so there's no need to remove the hearing protection in hazardous areas.

External audio input

Connects wireless devices or media players via a cable.

Charging socket USB Type-C

Fast charging time thanks to higher performance. Easy handling thanks to rotationally symmetrical connectors.

IP 54 Protection class

Suitable for outdoor use or dusty and damp working areas thanks to sealing caps.

Hands-free telephony

Make calls without interrupting your work thanks to Bluetooth connectivity.



LED display

Signals your current work mode, e.g. whether you are making a phone call or are available.

Unique function keys

Can be felt easily and can also be operated even when wearing gloves.



Hear what's important

The smart hearing protection for greater occupational safety



Outdoor microphones for secure communication

uvex aXess one are active electronic earmuffs with RAL function (real active listening). This function gives the user the feeling of not wearing hearing protection and of actively participating in the environment with hearing protection. This makes communication possible and warning signals can be perceived better. The volume of the ambient sounds can be set individually.

For safe hearing protection, the maximum output level is limited. The level gain below the sound level limiter is very helpful, for example when adjusting machines or performing diagnostic work.

Conveniently answer calls via Bluetooth®

uvex aXess one connects to your smartphone via Bluetooth 5.2, meaning you no longer miss important calls and can make them without interrupting your work. Dual mode allows you to add another device if needed.

Calls can be answered quickly and easily using the function keys on the earmuffs, so both hands are free when you make calls. The large radio range ensures that paired devices can remain in a protected location rather than at the workplace.



2640001



Protection against dust and moisture

Closure caps seal connector sockets.



uvex aXess one

- active Bluetooth® earmuffs with foldable headband
- communication, telephony and streaming
- attenuation of harmful impulse noise
- real active listening function for clear perception of ambient noise
- buttons with a shape that corresponds to their function
- IP54 water and dust protected ideal for outdoor applications
- battery status indicator and battery warning message
- continuous length adjustment for the perfect positioning
- padded headband for a comfortable fit
- microphone covers can be used to minimise wind noise or provide additional protection

uvex aXess one	
Art. no.	2640001
Design	Active earmuffs with Bluetooth
SNR protection value	31 dB
H-M-L value	H: 37 dB, M: 29 dB, L: 21 dB
Weight	360 g
Colour	matt black, grey
Order unit	PC

Hearing Protection

Earmuffs – Tested in accordance with DIN EN 352-1



2000002



SNR
dB
30

2630010



SNR
dB
33

2630020



SNR
dB
36

2630030

Note: Order earmuff bag separately



uvex K10 · uvex K20 · uvex K30

- earmuffs with foldable headband
- variable length adjustment for easy positioning
- optimal earmuff shape for pressure-free protection of the outer ear
- padded headband for wearer comfort

- wearer comfort guaranteed thanks to extra-soft memory foam earmuff cushions, even when worn for long periods
- replaceable earmuff cushions for high hygiene requirements

Art. no.	uvex K10 2630010	uvex K20 2630020	uvex K30 2630030	uvex earmuff bag 2000002
Design	with foldable headband	with foldable headband	with foldable headband	with belt loop and hook-and-loop fastener
SNR protection value	30 dB	33 dB	36 dB	
H-M-L value	H: 35 dB, M: 28 dB, L: 19 dB	H: 36 dB, M: 32 dB, L: 22 dB	H: 37 dB, M: 34 dB, L: 26 dB	
Weight	185 g	230 g	385 g	
Colour	black, green	black, yellow	black, red	
Order unit	PC	PC	PC	PC

Hearing Protection

Earmuffs – Tested in accordance with DIN EN 352-1



2630011



uvex KX10

- earmuffs with rubberised surface
- increased grip and secure fit, ideal for oily or damp environments
- foldable headband
- variable length adjustment for easy positioning
- optimal earmuff shape for pressure-free protection of the outer ear
- padded headband for wearer comfort
- comfortable fit guaranteed thanks to extra-soft memory foam earmuff cushions, even when worn for long periods
- replaceable earmuff cushions for high hygiene requirements

uvex KX10	
Art. no.	2630011
Design	Hearing protection earmuffs with rubberised surface
SNR protection value	30 dB
H-M-L value	H: 35 dB, M: 28 dB, L: 19 dB
Weight	185 g
Colour	matt black, green
Order unit	PC



2630021



uvex K20 hi-viz

- earmuffs in fluorescent colours thanks to the high-visibility design
- foldable headband
- variable length adjustment for easy positioning
- optimal earmuff shape for pressure-free protection of the outer ear
- padded headband for wearer comfort
- comfortable fit guaranteed thanks to extra-soft memory foam earmuff cushions, even when worn for long periods
- replaceable earmuff cushions for high hygiene requirements

uvex K20 hi-viz	
Art. no.	2630021
Design	with foldable headband
SNR protection value	33 dB
H-M-L value	H: 36 dB, M: 32 dB, L: 22 dB
Weight	230 g
Colour	hi-viz
Order unit	PC

Hearing Protection

Earmuffs – Tested in accordance with DIN EN 352-1



2600001



2600002



2600003



2600004

uvex K1 · uvex K2 · uvex K3 · uvex K4

- earmuffs with length adjustment
- lightweight with a small cup
- easily adjustable for a perfect fit

- padded headband for optimum wearer comfort
- wearer comfort guaranteed thanks to extra-soft memory foam ear cushions, even when worn for long periods (excluding uvex K1)

	uvex K1	uvex K2	uvex K3	uvex K4
Art. no.	2600001	2600002	2600003	2600004
Design	with headband	with headband	with headband	with headband
SNR protection value	28 dB	32 dB	33 dB	35 dB
H-M-L value	H: 35 dB; M: 24 dB; L: 17 dB	H: 37 dB; M: 29 dB; L: 21 dB	H: 36 dB; M: 30 dB; L: 22 dB	H: 38 dB; M: 33 dB; L: 24 dB
Weight	180 g	217 g	297 g	356 g
Colour	black, green	black, yellow	black, red	neon lime
Order unit	PC	PC	PC	PC

Hearing Protection

Earmuffs – Tested in accordance with DIN EN 352-1



2600012

SNR
dB
31



SNR
dB
28



possible wearing styles



2600200

uvex K2 foldable

- dielectric earmuffs with length adjustment and foldable headband
- lightweight with a small cup
- extra-soft memory foam ear cushions for wearer comfort
- hi-vis design for improved wearer visibility

uvex K200

- dielectric ear muffs with length adjustment
- suitable for use in workplace environments with exposure to electrical voltage
- adjustable headband for a perfect fit and optimum protection
- easily adjustable for a customised fit
- range of positions possible with 360° capsule rotation

uvex K2 foldable	
Art. no.	2600012
Design	with foldable headband
SNR protection value	31 dB
H-M-L value	H: 35 dB, M: 29 dB, L: 21 dB
Weight	229 g
Colour	neon lime
Order unit	PC

uvex K200	
Art. no.	2600200
Design	with 360° headband rotatable
SNR protection value	28 dB
H-M-L value	H: 33 dB, M: 25 dB, L: 18 dB
Weight	173 g
Colour	black, ochre
Order unit	PC



2600000



2600010



2600011



2600013

SNR
dB
29

uvex K Junior

- earmuffs with shorter headband
- suitable for head widths up to 145 mm, equivalent to sizes S/M
- padded headband and soft cushions for optimum wearer comfort

uvex K Junior				
Art. no.	2600000	2600010	2600011	2600013
Design	with shorter headband	with shorter headband	with shorter headband	with shorter headband
SNR protection value	29 dB	EN 352-1	EN 352-1	EN 352-1
H-M-L value	H: 34 dB, M: 26 dB, L: 18 dB	H: 34 dB, M: 26 dB, L: 18 dB	H: 34 dB, M: 26 dB, L: 18 dB	H: 34 dB, M: 26 dB, L: 18 dB
Weight	167 g	167 g	167 g	167 g
Colour	yellow	blue	lime	pink
Order unit	PC	PC	PC	PC

Hearing Protection

Helmet earmuffs for 30-mm Euroslot – Tested in accordance with DIN EN 352-3



uvex K10H · uvex K20H · uvex K30H

- hearing protection earmuffs that can be attached to a safety helmet using the 30-mm Euroslot
- dielectric design
- soft, variable length adjustment
- sound isolation thanks to the rubber-cushioned earmuffs
- length is easily adjustable for a perfect fit on the helmet
- 360° rotation for standby and resting positions
- wearer comfort guaranteed thanks to extra-soft memory foam earmuff cushions, even when worn for long periods
- not compatible with the uvex pheos visor system

	uvex K10H	uvex K20H	uvex K30H
Art. no.	2630210	2630220	2630230
Design	dielectric helmet earmuffs for 30-mm Euroslot	dielectric helmet earmuffs for 30-mm Euroslot	dielectric helmet earmuffs for 30-mm Euroslot
SNR protection value	28 dB	30 dB	34 dB
H-M-L value	H: 34 dB; M: 26 dB; L: 18 dB	H: 34 dB; M: 28 dB; L: 20 dB	H: 36 dB; M: 32 dB; L: 24 dB
Weight	216 g	263 g	420 g
Colour	black, green	black, yellow	black, red
Order unit	PR	PR	PR

Hearing Protection

Helmet earmuffs for 30-mm Euroslot - Tested in accordance with DIN EN 352-3



uvex K1H · uvex K2H

- not compatible with the uvex pheos visor system
- length is easily adjustable for a perfect fit on the helmet
- 360° rotation for standby and resting positions
- soft ear cushions adapt to surface and head shape to ensure optimum wearer comfort (uvex K1H)

- wearer comfort guaranteed thanks to extra-soft memory foam ear cushions, even when worn for long periods (uvex K2H)

	uvex K1H	uvex K2H
Art. no.	2600201	2600202
Design	helmet earmuffs for 30-mm Euroslot	helmet earmuffs for 30-mm Euroslot
SNR protection value	27 dB	30 dB
H-M-L value	H: 32 dB; M: 24 dB; L: 17 dB	H: 35 dB, M: 27 dB, L: 20 dB
Weight	210 g	251 g
Colour	black, green	black, yellow
Order unit	PR	PR

Combination options K10H · K20H · K30H · K1H · K2H

Compatible with the following products:

uvex industrial safety helmets uvex pronamic alpine, uvex pheos ABS, uvex pheos B, uvex pheos B-WR, uvex pheos B-S-WR, uvex pheos IES, uvex pheos alpine, uvex airwing, uvex perffexion, uvex super boss (page 122 onwards) together with the K10H, K20H, K30H, K1H, K2H helmet earmuffs (page 104/105) and the 9790 visor (page 141)



K10H,K20H,K30H
all uvex pheos models,
K1H, K2H not for
uvex pheos E
(not dielectric)

uvex pheos alpine

uvex airwing

uvex superboss

uvex pronamic alpine

uvex perffexion

Hearing Protection

uvex pheos helmet system

Adapts perfectly to your requirements – thanks to the flexible modular system.



Every detail of the new pheos helmet system has been carefully thought through to deliver an advanced head protection solution. The magnetic locking system makes it simple to attach the visor and ear muffs, while the ergonomic joint system makes it extremely comfortable to wear for long periods.



Magnetic lock system
for visor and ear muffs

One click attachment system

The unique magnetic lock system allows parts to connect easily – the helmet does not need to be removed when attaching or removing the ear muffs.

Extra-soft ear muffs

Wearer comfort guaranteed thanks to extra-soft memory foam ear cushions, even when worn for long periods.

Hearing Protection

uvex pheos helmet earmuffs – Tested in accordance with DIN EN 352-3



SNR
dB
28

2600216

SNR
dB
30

2600214
2600215

uvex pheos K2P
magnetic connection

uvex pheos K2P and K1P
bayonet connection

uvex pheos K1P · uvex pheos K2P

- the soft foam ear cushion of the K1P adapts to the wearer's head shape to ensure optimum wearer comfort
- the K2P guarantees a comfortable fit thanks to extra-soft memory foam earmuff cushions, even when worn for long periods
- 360° rotation for standby and resting positions
- both variants are available in a bayonet version and can be attached and removed quickly and easily without tools (only possible in combination with a uvex helmet including mounted pheos visor or on the pheos faceguard)
- helmet earmuffs can only be used with uvex pheos visors
- K2P available as a magnetic variant so the earmuffs can be quickly and easily attached and removed without having to take off the helmet (Only possible in combination with helmet adapter 9790078 or a uvex helmet including mounted magnetic pheos visor system)
- easy, convenient height adjustment of earmuffs
- dielectric

	uvex pheos K1P	uvex pheos K2P	uvex pheos K2P magnetic
Art. no.	2600216	2600214	2600215
Design	bayonet connection	bayonet connection	magnetic connection
SNR protection value	28 dB	30 dB	30 dB
H-M-L value	H: 34 dB, M: 25 dB, L: 18 dB	H: 35 dB, M: 27 dB, L: 20 dB	H: 35 dB, M: 27 dB, L: 20 dB
Weight	191 g	235 g	240 g
Colour	black, grey	black, yellow	black, yellow
Order unit	PR	PR	PR

Magnetic helmet adapter

Art. no.	9790078
Design	helmet adapter for magnetic helmet earmuffs
Order unit	PR

The adapter is required to attach the uvex pheos K2P magnetic earmuffs 2600215 to the helmet. If a pheos visor is already mounted magnetically, this adapter is no longer required. The adapter can be retrofitted to a helmet at any time via the 30-mm Euroslot. The adapter only fits uvex pheos and uvex pheos alpine helmets.



9790078

Hearing Protection

Earplug accessories



6177116



2111404



2134000

uvex clear otoplastics

- silicone-free towelettes for quick and easy cleaning of reusable ear plugs

uvex clear otoplastics	
Art. no.	6177116
Content	30 towelettes per PC
Order unit	PC

uvex earplug box

- box for hygienic earplug storage
- compact and dirt-resistant design
- for one pair of reusable earplugs with cord
- or two pairs of reusable earplugs without cord

uvex earplug box	
Art. no.	2111404
Design	earplugs not included
Colour	transparent
Content	50 PC per Box
Order unit	CT

Wall bracket for dispenser box

- plexiglas wall-mounted dispenser, suitable for uvex x-fit (2112001, 2112010, 2112011), uvex com4-fit (2112004, 2112012), uvex one-fit (2112045), uvex xtra-fit (2112060), uvex hi-com (2112100, 2112101, 2112106, 2112114).

Wall bracket for dispenser box	
Art. no.	2134000
Material	PMMA
Colour	transparent
Order unit	PC



Hearing protection tester box

- Find the perfect hearing protection for you:
- box containing selection of uvex disposable/reusable and detectable hearing protection earplugs plus uvex xact-band banded ear protectors
 - article number: 1000929

Usage poster

- Article numbers
- 1001165 (German)
 - 1001166 (English)
 - Size: A2

Hearing protection guide

- 25 pages
- with Euro holes
- includes all essential information about hearing protection
- art. no.: 1001.214 (German)
- art. no.: 1001.215 (English)

Hearing protection

Earmuff accessories



2599978



2599971
2599972



2592640

uvex K series comfort pads “uvex dry pads”

- accessories for all models in the uvex K series
- the comfort pads can be attached to the sealing cushions to absorb moisture and sweat

uvex K series comfort pads “uvex dry pads”	
Art. no.	2599978
Design	self-adhesive, suitable for all models in the uvex K series
Content	10 Pads in BG
Order unit	BG

uvex K Series · Hygiene kits

	uvex K series hygienekit standard	uvex K series hygienekit-premium
Art. no.	2599971	2599972
Design	accessories for uvex K1, uvex K1H, uvex K1P, uvex K200, uvex K junior	accessories for uvex K2, uvex K2 foldable, uvex K3, uvex K4, uvex K10, uvex KX10, uvex K20, uvex K30, uvex K2H uvex K2P, uvex K10H, uvex K20H, uvex K30H, uvex aXess one
Content	2 ear pads and 2 muffling pads in BG	in BG
Order unit	BG	BG

uvex microphone cover

uvex microphone cover	
Art. no.	2599978
Design	Set of nine, self-adhesive, suitable for the uvex aXess series
Order unit	BG



2000002



2000000



uvex earmuff bag

uvex earmuff bag	
Art. no.	2000002
Design	with belt loop and hook-and-loop fastener
Size	150x120x120 mm
Order unit	PC

Storage box for earmuffs

Storage box for earmuffs	
Art. no.	2000000
Design	Plastic storage box
Size	236x225x125 mm
Order unit	PC

Sample case for earplugs

- empty, with six compartments for earmuffs
- art. no.: 2599966

Hearing Protection

Overview

Art. no.	Name	Product	Colour	Content	Page
2000000		Aufbewahrungsbox	blue	PC	109
2000002		Earmuff bag		PC	109
2111201	uvex whisper	Reusable earplugs with cord in a mini box	orange	50 PR, in pairs in CT	93
2111212	uvex whisper+	Reusable earplugs with cord in a mini box	lime	50 PR, in pairs in CT	93
2111235	uvex whisper supreme	Reusable earplugs with cord in earplug box	yellow	50 PR, in pairs in CT	93
2111237	uvex whisper	Reusable earplugs with cord in earplug box	orange	50 PR, in pairs in CT	93
2111238	uvex whisper+	Reusable earplugs with cord in earplug box	lime	50 PR, in pairs in CT	93
2111239	uvex whisper+ detec	Detectable reusable earplugs with cord in earplug box	blue	50 PR, in pairs in CT	95
2111260	uvex whisper+ detec	Reusable earplugs with cord in a mini box		50 PR, in pairs in CT	95
2111261	uvex whisper detec	Reusable earplugs with cord in a mini box		50 PR, in pairs in CT	95
2111262	uvex whisper detec	Reusable earplugs with cord in a mini box		50 PR, in pairs in CT	95
2111404		uvex earplug box	transparent	CT	108
2111988	one 2 click	dispenser, empty, magnetic		CT	90
2111989		Magnetic wall bracket for dispenser		CT	90
2111990	one 2 click	Dispenser filled with 600 pairs of x-fit earplugs		600 PR, x-fit	90
2111991	one 2 click	Dispenser filled with 600 pairs of com4-fit earplugs		600 PR, xcom4-fit	90
2111992	one 2 click	Dispenser filled with 600 pairs of hi-com earplugs		600 PR, hi-com	90
2112000	one 2 click	Dispenser for 600 pairs of earplugs, empty		CT	90
2112001	uvex x-fit	Disposable earplugs without cord	lime	200 PR, packed in pairs in CT	89
2112004	uvex com4-fit	Disposable earplugs without cord	light orange	200 PR, packed in pairs in CT	89
2112010	uvex x-fit	Disposable earplugs with cord	lime	100 PR, packed in pairs in CT	89
2112011	uvex x-fit detec	Detectable disposable earplugs with cord	blue	100 PR, in pairs in CT	94
2112012	uvex com4-fit	Disposable earplugs with cord	light orange	100 PR, packed in pairs in CT	89
2112013	uvex x-fit	Disposable earplugs without cord		50 PR, loose in CT	89
2112022	uvex x-fit	Refill box	lime	300 PR, loose in CT	90
2112023	uvex com4-fit	Refill box	light orange	300 PR, loose in CT	90
2112060	uvex xtra-fit	Disposable earplugs without cord	orange	200 PR, packed in pairs in BG	89
2112061	uvex xtra-fit	Refill box	orange	250 PR, loose in BG	90
2112087	uvex x-fit	Disposable earplugs without cord	lime	100 PR, packed in pairs in CT	89
2112093	uvex xtra-fit	Minidispenser Box	orange	100 PR, packed in pairs in CT	89
2112094	uvex x-fit	Minidispenser Box	lime	100 PR, packed in pairs in CT	89
2112095	uvex hi-com	Minidispenser Box	lime	100 PR, packed in pairs in CT	88
2112096	uvex com4-fit	Minidispenser Box	light orange	100 PR, packed in pairs in CT	89
2112100	uvex hi-com	Disposable earplugs without cord	lime	200 PR, packed in pairs in CT	88
2112101	uvex hi-com	Disposable earplugs with cord	lime	100 PR, packed in pairs in CT	88
2112106	uvex hi-com	Disposable earplugs without cord	beige	200 PR, packed in pairs in CT	88
2112114	uvex hi-com detec	Detectable disposable earplugs with cord	blue	100 PR, in pairs in CT	94
2112118	uvex hi-com	Refill box	lime	300 PR, loose in CT	90
2112119	uvex hi-com	Refill box	beige	300 PR, loose in CT	90
2112131	uvex com4-fit	Disposable earplugs without cord	light orange	15 PR, loose in CT	89
2112133	uvex x-fit	Disposable earplugs without cord		15 PR, loose in CT	89
2124001	uvex xact-fit	Earplugs with cord and pin	lime, grey	50 PR, packed in pairs in CT	92
2124002	uvex xact-fit	Replacement earplugs	lime	250 PR, CT of 5 pairs	92
2124003	uvex xact-fit	Refill box	lime	400 PR, loose in CT	90
2124011	uvex xact-fit detec	Detectable earplugs with pin	blue	50 PR, in pairs in CT	94
2124013	uvex xact-fit detec	Replacement earplugs	blue	400 PR, loose in CT	94
2124017	uvex xact-fit multi reusable S	Reusable earplugs with oval-shaped reusable plugs	grey, transparent	50 PR, packed in pairs in CT	92
2124018	uvex xact-fit multi reusable M/L	Reusable earplugs with oval-shaped reusable plugs	grey, transparent	50 PR, packed in pairs in CT	92
2124019	uvex xact-fit multi reusable S	Reusable earplugs with oval-shaped reusable plugs	grey, transparent	50 PR, packed in pairs in CT	92
2124020	uvex xact-fit multi reusable M/L	Reusable earplugs with oval-shaped reusable plugs	grey, transparent	50 PR, packed in pairs in CT	92
2124026	uvex xact-fit planet	Earplugs with pin	lime	50 PR, packed in pairs in CT	92
2125344	uvex x-fold	Folding banded ear protector	grey, sky blue, lime	5 PC, individually packed in CT	96
2125351		Replacement earplugs for uvex x-cap and uvex x-fold	sky blue, lime	60 PR, CT of 5 pairs	96
2125361	uvex x-cap	Banded ear protector	grey, sky blue, lime	15 PC, individually packed in CT	96
2125372	uvex xact-band	Banded ear protector	grey, sky blue, lime	5 PC, individually packed in CT	96
2134000		Wall-mounted dispenser		PC	108
2592640		Mikrofonabdeckung	black	BG	109
2599971		Hygiene kit uvex K series standard		2 ear pads and 2 muffling pads in BG	109
2599972		Hygiene kit uvex K series premium		2 ear pads and 2 muffling pads in BG	109
2599978		Comfort pads		10 Pads in BTL	109
2600000	uvex K junior	Passive earmuffs	yellow, black	PC	103
2600001	uvex K1	Passive earmuffs	black, green	PC	102
2600002	uvex K2	Passive earmuffs	black, yellow	PC	102
2600003	uvex K3	Passive earmuffs	black, red	PC	102
2600004	uvex K4	Passive earmuffs	neon lime	PC	102
2600010	uvex K junior	Passive earmuffs	blue	PC	103
2600011	uvex K junior	Passive earmuffs	lime	PC	103
2600012	uvex K2 foldable	Passive earmuffs	neon lime	PC	103
2600013	uvex K junior	Passive earmuffs	pink	PC	103
2600200	uvex K200	Passive earmuffs	black, ochre	PC	103
2600201	uvex K1H	Earmuffs with helmet attachment	black, green	PR	105
2600202	uvex K2H	Earmuffs with helmet attachment	black, yellow	PR	105
2600214	uvex pheos K2P	Earmuffs with helmet attachment	black, yellow	PR	107
2600215	uvex pheos K2P magnet	Earmuffs with helmet attachment	black, yellow	PR	107
2600216	uvex pheos K1P	Earmuffs with helmet attachment	black, grey	PR	107
2630010	uvex K10	Earmuffs with helmet attachment	black, green	PC	100
2630011	uvex KX10	Earmuffs with helmet attachment	matt black, green	PC	101
2630020	uvex K20	Earmuffs with helmet attachment	black, yellow	PC	100
2630021	uvex K20 hi-viz	Earmuffs with helmet attachment	hi-viz	PC	101
2630030	uvex K30	Earmuffs with helmet attachment	black, red	PC	100
2630210	uvex K10H	Earmuffs with helmet attachment	black, green	PC	104
2630220	uvex K20H	Earmuffs with helmet attachment	black, yellow	PC	104
2630230	uvex K30H	Earmuffs with helmet attachment	black, red	PC	104
2640001	uvex aXess one	Active earmuffs	matt black, grey	PC	99
6177116	uvex clear otoplastics	silicone-free towelettes		30 towelettes, PC	108
9790078		Helmet adapter	black	PR	107



Safety Helmets

Standards at a glance

EN 397 · EN 50365

EN 397 – Industrial safety helmets













Protection against falling objects and the consequences thereof, such as brain damage and skull fracture

Binding requirements: all helmets certified according to EN 397 must meet these requirements.

- shock absorption, vertical
- penetration resistance (against sharp and pointed objects)
- flame resistance
- chin strap attachment: chin strap releases at minimum 150 N and maximum 250 N

Optional requirements: a helmet certified in accordance with EN 397 may meet these requirements; they are, however, not mandatory requirements.

- very low temperatures (-20°C or -30°C)
- very high temperatures (+150°C)
- electrical insulation (440 V)
- molten metal (MM)
- lateral deformation

very low temperatures (-20°C or -30°C)	 uvex airwing	 uvex super boss	 uvex pheos	 uvex pheos alpine	 uvex perffexion	 uvex pronamic alpine
very high temperatures (+150°C)		 uvex thermo boss				
electrical insulation (440 V)	 uvex airwing E	 uvex thermo boss				
molten metal (MM)			 uvex pheos			 uvex pronamic alpine
lateral deformation					 uvex perffexion	 uvex pronamic alpine

EN 50365 – Insulating helmets for use on low voltage installations

Protection against electric shocks and prevention of dangerous electric current passing through the head

Requirements:

- All helmets must also meet the requirements in accordance with EN 397.
- Protection against alternating voltage of up to 1000 V (AC) or direct voltage up to 1500 V (DC)
- Insulating helmets must not contain any conductive parts.
- Air vents (if available) must not allow any accidental contact with live parts.



uvex pheos E

Overview of standards

EN 12492 · EN 1078

EN 12492 – Helmets for mountaineers

Protection against hazards that may occur during activities undertaken by mountaineers

Requirements:

- Shock absorption, vertical, frontal, lateral, dorsal
- Carrier element (chin strap releases at min. 500 N)
- Strength of carrier element: Chin strap may exhibit maximum elongation of 25 mm
- Carrier element effectiveness: Helmet must not slide from the head



uvex pheos alpine

uvex perffexion

uvex pronamic alpine



EN 1078: European standard for cycling helmets

Helmets for pedal cyclists and for users of skateboards and roller skates

Requirements:

- absorbs impact from vertical force
- low temperatures (-20°C)
- the effectiveness of the retention system must be ensured via a retention test
- the mechanical strength of the chin strap must be ensured – the maximum permissible elongation is 35 mm



uvex perffexion



Safety Helmets

uvex pronamic alpine



Generous ventilation

The side air vents significantly improve the temperature inside the helmet.



Optimal adjustment

The wheel ratchet system provides plenty of scope for adjustments and the suspension harness inside the helmet can be adjusted as desired to provide the perfect fit for the wearer's head shape



EN 12492 and EN 397

The best equipment for various applications. Whether used while working at height or as an industrial safety helmet, the helmet's chin strap system is quick and easy to change, enabling the helmet to fulfil the safety standards for both applications and offer optimum protection at all times



MIPS included

An additional MIPS inner shell can be integrated as an option to absorb rotational energy, reducing the force transferred to the wearer's head. A detailed description of how the MIPS safety system works can be found on page 117.



Accessories can be fitted easily and quickly

The four stylistic retaining clips guarantee an optimal fit of the helmet accessories. This ensures that the user has access to any necessary application-related products, such as helmet torches or goggles, and that these are in the perfect position at all times.



Further information can be found at uvex-safety.com/en/uvex-pronamic-alpine (or scan the QR code).

Safety Helmets

uvex pronamic alpine



LD-tested

uvex pronamic alpine

- multi-standard helmet that meets the requirements of EN 397 and EN 12492
- patented MIPS inner shell available as an option
- side Euroslot adapters (30 mm) for attaching earmuffs
- four retaining clips for fitting head torches or goggles
- additional elements allow our wide range of accessories to be attached to the helmet
- air vents for maximum ventilation
- versatile and adjustable suspension harness with variable wheel ratchet system
- EPS inner shell ensures excellent fit and comfort
- EN 12492 forked chin strap (art. no. 9790351) included in the standard scope of delivery, EN 397 version (art. no. 9790021) sold separately as an accessory
- replaceable hygiene kits 9790350 and 9790352 (MIPS)

uvex pronamic alpine						
Art. no.	9735030	9735130	9735230	9735031	9735131	9735231
Colour	white	hi-viz yellow	hi-viz orange	white	hi-viz yellow	hi-viz orange
Version				Mips	Mips	Mips
Material	ABS	ABS	ABS	ABS	ABS	ABS
Standard	EN 12492, EN 397	EN 12492, EN 397	EN 12492, EN 397	EN 12492, EN 397	EN 12492, EN 397	EN 12492, EN 397
	-30°C, MM, LD	-30°C, MM, LD	-30°C, MM, LD	-30°C, MM, LD	-30°C, MM, LD	-30°C, MM, LD
Sizes	51 to 63 cm	51 to 63 cm	51 to 63 cm	51 to 63 cm	51 to 63 cm	51 to 63 cm
Order unit	PC	PC	PC	PC	PC	PC
Outer packaging	8 PC per CT	8 PC per CT	8 PC per CT	8 PC per CT	8 PC per CT	8 PC per CT

Safety Helmets

uvex pheos S-KR Mips



MIPS inner shell

The additional MIPS safety system is integrated into the suspension harness.



Large neck piece

The additional neck piece increases the contact surface, reducing pressure on the back of the wearer's head. This improves the wearing comfort.



Pre-mounted forked chin strap

The comfortable forked chin strap secures the helmet and guarantees optimum protection, especially when carrying out overhead work

Safety Helmets

uvex pheos S-KR Mips

What is MIPS?

The MIPS safety system is designed to provide additional protection for helmets during a wide variety of accidents. In certain impact situations, the MIPS system can reduce dangerous forces that might otherwise be transferred to the helmet wearer's head.

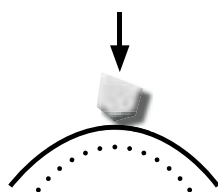

Linear impacts

Conventional helmets are designed and tested for linear impacts. In most cases, however, impacts occur at an angle and lead to a rotational movement of the head.

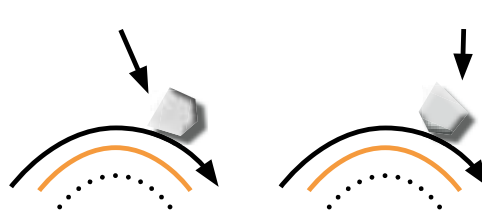

Angled impacts

The low-friction inner shell is designed to help reduce the rotational forces acting on the head in certain cases of an angled impact.



Further information can be found at uvex-safety.com/en/mips/ (or scan the QR code).



9772260

uvex pheos S-KR Mips

- safety helmet with slots for uvex visors, helmet earmuffs and helmet torches
- MIPS inner shell absorbs rotational forces
- side Euroslot adapters (30 mm) for attaching earmuffs
- three adjustable air vents for maximum ventilation
- suspension harness with wheel ratchet system for variable width adjustment
- six-point textile band attachment ensures excellent fit and comfort
- pre-mounted forked chin strap (9790021)
- large neck piece (9790149) increases wearing comfort
- fitted with a sweatband (9760260)

uvex pheos S-KR Mips	
Art. no.	9772260
Colour	hi-viz orange
Version	with short brim
Material	HDPE
Standard	EN 397
	-30°C, MM
Sizes	52 to 61 cm
Order unit	PC
Outer packaging	20 PC per CT

protecting planet

To help raise awareness of its commitment to achieving increased sustainability, uvex has developed the **protecting planet** icon.

For uvex, **protecting planet** is more than a label. Based on the brand claim, **protecting people**, our sustainable approach integrates three core interlinked pillars – **ecology, economy** and **social responsibility**, that are incorporated throughout the business to improve our sustainability performance.

This explains the comprehensive audit, measurement and evaluation management process uvex undertakes along the entire value chain to ensure its products are as sustainable as possible.



uvex pheos planet

uvex pheos planet B-WR // uvex pheos planet B-S-WR

The **uvex pheos planet** is an example of the **planet series** product system.



protecting planet

by using recycled material //
by using bio-based material

The helmet shell is made of up to 30 percent bioplastic. The organic raw material, sugar cane, is converted using a process that complies with the strictest quality requirements and achieves high stability and strength. 50 percent of the material for the headband is made of helmet shells. This significantly reduces process-related waste during production.



protecting planet

by using environmentally-
friendly packaging

All individual packaging is made of regranulated material and has been taken from the recycling economy. The packaging is single-grade and can be returned to the recycling chain after use. This also saves fossil resources. The user instructions are printed on 100 percent recycled paper.

uvex pheos planet B-WR
uvex pheos planet B-S-WR

- helmet shell partially made of bioplastic
- headbands made of regranulated helmet shells



	uvex pheos planet B-WR	uvex pheos planet B-S-WR
Art. no.	9772042	9772043
Colour	white	white
Type	with long brim	with short brim
Material	HDPE	HDPE
Standard	EN 397	EN 397
	-30 °C, MM	-30 °C, MM
Sizes	52 to 61 cm	52 to 61 cm
Order unit	PC	PC
Outer packaging	25 PC per CT	25 PC per CT

uvex perfexxion

Adjustable head protection for optimum wearer comfort



No hot spots thanks to maximum ventilation

Adjustable air vents ensure optimal air circulation and prevent uncomfortable hot spots under the helmet



High wearer comfort

The integrated inner mesh and padded suspension harness make the helmet even more comfortable. The mesh ensures optimal ventilation.

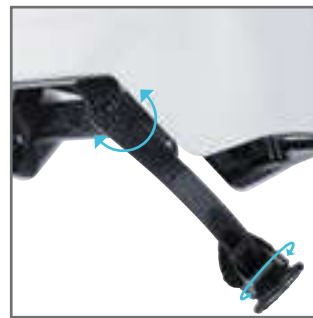

Perfect fit

With variable width and height adjustment

uvex perfexxion meets all the applicable protection standards for use as an industrial helmet, a mountaineering helmet or a cycling helmet – and with its optimised temperature cooling and ergonomic fit, it's exceptionally comfortable to wear.

Safety Helmets

uvex perffexion



9720940



9720040



9720950



9720050



LD-tested

uvex perffexion

- unique combination of the standards EN 397 (meets partly), EN 12492 and EN 1078
- side Euroslot adapters (30 mm) for attaching earmuffs
- additional slots allow for a wide variety of accessories to be attached
- complies with the following standards:
 - EN 397 (in part) – Industrial safety helmet standard
 - optional requirements: LD, -30°C
 - EN 12492 – Mountaineering helmet standard
 - EN 1078 – Cycling helmet standard
- increased resistance to lateral deformation (LD) provides additional protection
- adjustable and convenient air vents for maximum ventilation
- suspension harness with wheel ratchet system for variable width adjustment and height adjustment
- suspension harness with convenient inner mesh for added wearer comfort
- optimal fit thanks to two different sizes (M and L)
- additional clip-on brim included in the scope of delivery

uvex perffexion				
Art. no.	9720940	9720950	9720040	9720050
Colour	black	black	white	white
Version	with short brim	with short brim	with short brim	with short brim
Material	ABS	ABS	ABS	ABS
Standard	EN 397, -30 °C, LD EN 12492, EN 1078	EN 397, -30 °C, LD EN 12492, EN 1078	EN 397, -30 °C, LD EN 12492, EN 1078	EN 397, -30 °C, LD EN 12492, EN 1078
Sizes	M (52 to 58 cm)	L (59 to 63 cm)	M (52 to 58 cm)	L (59 to 63 cm)
Order unit	PC	PC	PC	PC
Outer packaging	6 PC per CT	6 PC per CT	6 PC per CT	6 PC per CT

Safety Helmets

uvex airwing B · uvex airwing B-WR · uvex super boss



uvex airwing B · uvex airwing B-WR

- safety helmet with slots for uvex visors and earmuffs
- side Euroslot adapters (30 mm) for attaching earmuffs
- meets standard EN 397 and additional requirement for very low temperatures (-30 °C)
- three variable air vents for maximum ventilation
- conventional suspension harness for comfortable adjustable fit (uvex airwing B)
- suspension harness with wheel ratchet for variable width adjustment (uvex airwing B-WR)
- fitted with the 9760005 sweatband
- six-point textile band attachment ensures optimal fit and comfort

uvex airwing B with conventional suspension harness							
Art. no.	9762020	9762120	9762220	9762320	9762420	9762520	9762920
Colour	white	yellow	orange	red	green	blue	black
Version	with long brim	with long brim	with long brim	with long brim	with long brim	with long brim	with long brim
Material	HDPE	HDPE	HDPE	HDPE	HDPE	HDPE	HDPE
Standard	EN 397, -30 °C	EN 397, -30 °C	EN 397, -30 °C	EN 397, -30 °C	EN 397, -30 °C	EN 397, -30 °C	EN 397, -30 °C
Sizes	51 to 61 cm	51 to 61 cm	51 to 61 cm	51 to 61 cm	51 to 61 cm	51 to 61 cm	51 to 61 cm
Order unit	PC	PC	PC	PC	PC	PC	PC
Outer packaging	25 PC per CT	25 PC per CT	25 PC per CT	25 PC per CT	25 PC per CT	25 PC per CT	25 PC per CT

uvex airwing B-WR with wheel ratchet system						
Art. no.	9762030	9762130	9762230	9762330	9762430	9762530
Colour	white	yellow	orange	red	green	blue
Version	with long brim	with long brim	with long brim	with long brim	with long brim	with long brim
Material	HDPE	HDPE	HDPE	HDPE	HDPE	HDPE
Standard	EN 397, -30 °C	EN 397, -30 °C	EN 397, -30 °C	EN 397, -30 °C	EN 397, -30 °C	EN 397, -30 °C
Sizes	52 to 61 cm	52 to 61 cm	52 to 61 cm	52 to 61 cm	52 to 61 cm	52 to 61 cm
Order unit	PC	PC	PC	PC	PC	PC
Outer packaging	25 PC per CT	25 PC per CT	25 PC per CT	25 PC per CT	25 PC per CT	25 PC per CT



uvex super boss

- safety helmet with slots for uvex visors and earmuffs
- side Euroslot adapters (30 mm) for attaching earmuffs
- meets standard EN 397 and additional requirement for very low temperatures (-20 °C)
- conventional suspension harness for comfortable adjustable fit
- fitted with the 9790004 sweatband
- adjustable side ventilation slits
- six-point textile band attachment ensures optimal fit and comfort

uvex super boss with conventional suspension harness			
Art. no.	9750020	9750120	9750520
Colour	white	yellow	blue
Version	with long brim	with long brim	with long brim
Material	HDPE	HDPE	HDPE
Standard	EN 397, -20 °C	EN 397, -20 °C	EN 397, -20 °C
Sizes	52 to 61 cm	52 to 61 cm	52 to 61 cm
Order unit	PC	PC	PC
Outer packaging	25 PC per CT	25 PC per CT	25 PC per CT



Safety Helmets

uvex airwing B-S · uvex airwing B-S-WR · uvex thermo boss



uvex airwing B-S · uvex airwing B-S-WR

- safety helmet with slots for uvex visors and earmuffs
- side Euroslot adapters (30 mm) for attaching earmuffs
- meets standard EN 397 and additional requirement for very low temperatures (-30 °C)
- three variable air vents for maximum ventilation
- conventional suspension harness for comfortable adjustable fit (uvex airwing B-S)

- suspension harness with wheel ratchet for variable width adjustment (uvex airwing B-S-WR)
- fitted with the 9760005 sweatband
- shorter brim for a wider field of upward vision
- six-point textile band attachment ensures optimal fit and comfort

uvex airwing B-S with conventional suspension harness

Art. no.	9762021	9762121	9762221	9762321	9762421	9762521
Colour	white	yellow	orange	red	green	blue
Version	with short brim	with short brim	with short brim	with short brim	with short brim	with short brim
Material	HDPE	HDPE	HDPE	HDPE	HDPE	HDPE
Standard	EN 397, -30 °C	EN 397, -30 °C	EN 397, -30 °C	EN 397, -30 °C	EN 397, -30 °C	EN 397, -30 °C
Sizes	51 to 61 cm	51 to 61 cm	51 to 61 cm	51 to 61 cm	51 to 61 cm	51 to 61 cm
Order unit	PC	PC	PC	PC	PC	PC
Outer packaging	25 PC per CT	25 PC per CT	25 PC per CT	25 PC per CT	25 PC per CT	25 PC per CT

uvex airwing B-S-WR with wheel ratchet system

Art. no.	9762031	9762131	9762231	9762331	9762431	9762531
Colour	white	yellow	orange	red	green	blue
Version	with short brim	with short brim	with short brim	with short brim	with short brim	with short brim
Material	HDPE	HDPE	HDPE	HDPE	HDPE	HDPE
Standard	EN 397, -30 °C	EN 397, -30 °C	EN 397, -30 °C	EN 397, -30 °C	EN 397, -30 °C	EN 397, -30 °C
Sizes	52 to 61 cm	52 to 61 cm	52 to 61 cm	52 to 61 cm	52 to 61 cm	52 to 61 cm
Order unit	PC	PC	PC	PC	PC	PC
Outer packaging	25 PC per CT	25 PC per CT	25 PC per CT	25 PC per CT	25 PC per CT	25 PC per CT



uvex thermo boss

- safety helmet with slots for uvex visors and earmuffs
- the helmet shell is made from heat-resistant polycarbonate and is suitable for use in high ambient temperatures.
- side Euroslot adapters (30 mm) for attaching earmuffs
- meets standard EN 397 and additional requirement (440 V AC) +150 °C
- conventional suspension harness for comfortable adjustable fit
- fitted with the 9790004 sweatband
- six-point textile band attachment ensures optimal fit and comfort

uvex thermo boss

Art. no.	9754000	9754100	9754300
Colour	white	yellow	red
Version	with long brim	with long brim	with long brim
Material	PC reinforced with fibreglass		
Standard	EN 397 +150 °C, 440 V AC	EN 397 +150 °C, 440 V AC	EN 397 +150 °C, 440 V AC
Sizes	52 to 61 cm	52 to 61 cm	52 to 61 cm
Order unit	PC	PC	PC
Outer packaging	25 PC per CT	25 PC per CT	25 PC per CT

MADE IN GERMANY



Safety Helmets

uvex pheos alpine



9773050



9773150



9773250



9773350



9773450



9773550



9773950



uvex pheos alpine

- multifunctional helmet for working at heights and rescue operations
- combines the features of an industrial protection helmet (EN 397) with the requirements for a climbing helmet (EN 12492)
- light ABS helmet shell offers a high level of protection and durability
- shorter brim for a wider field of upward vision
- side Euroslot adapters (30 mm) for attaching earmuffs and visor
- options for attaching head torches and goggles
- permanently opened air vents
- meets standard EN 397 and additional requirements for very low temperatures (-30°C)
- firmly riveted chin strap for use in accordance with EN 12492
- six-point textile band attachment ensures ideal fit and great comfort
- suspension harness with wheel ratchet system for variable width adjustment

- the helmet is delivered as standard with a black PU sweatband (art. no. 9760009); there is also an option of a light sweatband made of synthetic leather (art. no. 9760005)



product design award

2013

uvex pheos alpine with wheel ratchet system							
Art. no.	9773050	9773150	9773250	9773350	9773450	9773550	9773950
Colour	white	yellow	orange	red	green	blue	black
Version	with short brim	with short brim	with short brim	with short brim	with short brim	with short brim	with short brim
Material	ABS	ABS	ABS	ABS	ABS	ABS	ABS
Standard	EN 397, -30 °C EN 12492	EN 397, -30 °C EN 12492	EN 397, -30 °C EN 12492	EN 397, -30 °C EN 12492	EN 397, -30 °C EN 12492	EN 397, -30 °C EN 12492	EN 397, -30 °C EN 12492
Sizes	52 to 61 cm	52 to 61 cm	52 to 61 cm	52 to 61 cm	52 to 61 cm	52 to 61 cm	52 to 61 cm
Order unit	PC,	PC,	PC,	PC,	PC,	PC,	PC,
Outer packaging	individually packed in CT 6 PC per CT	individually packed in CT 6 PC per CT	individually packed in CT 6 PC per CT	individually packed in CT 6 PC per CT	individually packed in CT 6 PC per CT	individually packed in CT 6 PC per CT	individually packed in CT 6 PC per CT

Safety Helmets

uvex pheos forestry · uvex pheos ABS



Further information can be found at uvex-safety.com/en/forestryset (or scan the QR code).



9774236



9774237



9774238



uvex pheos forestry

- set specially developed to meet the needs of forestry workers, consisting of the uvex pheos ABS B-S-WR, uvex pheos forestry visor and uvex pheos K2P mechanical
- labelled with label set, including pre-attached chin strap and signal whistle
- meets standards EN 166, 1731, 352-1 and 397 and additional requirement for very low temperatures (-30 °C)
- fully integrated metal mesh visor with high transmission (transparency) protects against foreign objects and ensures a clear view
- high-insulation earmuffs (SNR: 30 dB) round off the system perfectly and reliably protect against noise produced by chainsaws and brush cutters
- three variable air vents for maximum ventilation, offering ventilation in the direction of movement
- suspension harness with wheel ratchet system enables the width to be variably adjusted with just one hand

uvex pheos forestry - pre-assembled set			
Art. no.	9774236	9774237	9774238
Colour	yellow	orange	red
Version	with short brim	with short brim	with short brim
Material	ABS	ABS	ABS
Standard	EN 397, -30 °C, MM	EN 397, -30 °C, MM	EN 397, -30 °C, MM
	EN 1731:2006-F	EN 1731:2006-F	EN 1731:2006-F
	EN 352-3	EN 352-3	EN 352-3
Sizes	52 to 61 cm	52 to 61 cm	52 to 61 cm
Order unit	PC	PC	PC
Outer packaging	15 PC per CT	15 PC per CT	15 PC per CT

uvex pheos forestry - spare parts		
Art. no.		Order unit
9790210	Replacement visor (metal)	PC
2600214	uvex K2P mechanical	PR
9760106	Replacement suspension harness pheos ABS	PC
9760009	Sweatband pheos ABS	PC
9790021	Four-point chin strap	PC
9790146	Signal whistle	PC



9772071



9772171



9772271



9772371

MADE IN GERMANY



uvex pheos ABS

- ABS safety helmet with slots for uvex visors, earmuffs and helmet lamps
- side Euroslot adapters (30 mm) for attaching earmuffs
- meets EN 397 standards and additional requirements for very low temperatures (-30°C)
- high lateral rigidity
- three variable air vents for maximum ventilation
- conventional suspension harness for comfortable adjustable fit (uvex pheos B)
- suspension harness with wheel ratchet system (9760106) and sweatband (9760009)
- six-point textile band attachment ensures optimum fit and comfort

uvex pheos ABS B-S-WR with wheel ratchet system				
Art. no.	9772071	9772171	9772271	9772371
Colour	white	yellow	orange	red
Version	with short brim	with short brim	with short brim	with short brim
Material	ABS	ABS	ABS	ABS
Standard	EN 397	EN 397	EN 397	EN 397
	-30 °C, MM	-30 °C, MM	-30 °C, MM	-30 °C, MM
Sizes	52 to 61 cm	52 to 61 cm	52 to 61 cm	52 to 61 cm
Order unit	PC	PC	PC	PC
Outer packaging	24 PC per CT	24 PC per CT	24 PC per CT	24 PC per CT

Safety Helmets

uvex pheos E · uvex pheos E-WR · uvex pheos E-S-WR



uvex pheos B · uvex pheos B-WR

- safety helmet with slots for uvex visors, earmuffs and lamps
- side Euroslot adapters (30 mm) for attaching earmuffs
- meets standard EN 397 and additional requirements for very low temperatures (-30 °C) and molten metal (MM) splash
- three variable air vents for maximum ventilation
- conventional suspension harness for comfortable adjustable fit (uvex pheos B)
- suspension harness with wheel ratchet for variable width adjustment (uvex pheos B-WR)
- fitted with the 9760005 sweatband
- six-point textile band attachment ensures optimal fit and comfort

uvex pheos B with conventional suspension harness						
Art. no.	9772020	9772120	9772220	9772320	9772520	9772920
Colour	white	yellow	orange	red	blue	black
Version	with long brim					
Material	HDPE	HDPE	HDPE	HDPE	HDPE	HDPE
Standard	EN 397	EN 397	EN 397	EN 397	EN 397	EN 397
	-30 °C, MM	-30 °C, MM	-30 °C, MM	-30 °C, MM	-30 °C, MM	-30 °C, MM
Sizes	51 to 61 cm	51 to 61 cm	51 to 61 cm	51 to 61 cm	51 to 61 cm	51 to 61 cm
Order unit	PC	PC	PC	PC	PC	PC
Outer packaging	25 PC per CT	25 PC per CT	25 PC per CT	25 PC per CT	25 PC per CT	25 PC per CT

uvex pheos B-WR with wheel ratchet system							
Art. no.	9772030	9772130	9772230	9772330	9772430	9772530	9772930
Colour	white	yellow	orange	red	green	blue	black
Version	with long brim						
Material	HDPE	HDPE	HDPE	HDPE	HDPE	HDPE	HDPE
Standard	EN 397	EN 397	EN 397	EN 397	EN 397	EN 397	EN 397
	-30 °C, MM	-30 °C, MM	-30 °C, MM	-30 °C, MM	-30 °C, MM	-30 °C, MM	-30 °C, MM
Sizes	52 to 61 cm	52 to 61 cm	52 to 61 cm	52 to 61 cm	52 to 61 cm	52 to 61 cm	52 to 61 cm
Order unit	PC	PC	PC	PC	PC	PC	PC
Outer packaging	25 PC per CT	25 PC per CT	25 PC per CT	25 PC per CT	25 PC per CT	25 PC per CT	25 PC per CT



uvex pheos B-S-WR

- safety helmet with slots for uvex visors, earmuffs and lamps
- side Euroslot adapters (30 mm) for attaching earmuffs
- meets standard EN 397 and additional requirements for very low temperatures (-30 °C) and molten metal (MM) splash
- three variable air vents for maximum ventilation
- suspension harness with wheel ratchet for variable width adjustment

- fitted with the 9760005 sweatband
- shorter brim for a wider field of upward vision
- six-point textile band attachment ensures optimal fit and comfort

uvex pheos B-S-WR with wheel ratchet system							
Art. no.	9772031	9772131	9772231	9772332	9772531	9772832	9772932
Colour	white	yellow	orange	red	blue	dark grey	black
Version	with short brim						
Material	HDPE	HDPE	HDPE	HDPE	HDPE	HDPE	HDPE
Standard	EN 397	EN 397	EN 397	EN 397	EN 397	EN 397	EN 397
	-30 °C, MM	-30 °C, MM	-30 °C, MM	-30 °C, MM	-30 °C, MM	-30 °C, MM	-30 °C, MM
Sizes	52 to 61 cm	52 to 61 cm	52 to 61 cm	52 to 61 cm	52 to 61 cm	52 to 61 cm	52 to 61 cm
Order unit	PC	PC	PC	PC	PC	PC	PC
Outer packaging	25 PC per CT	25 PC per CT	25 PC per CT	25 PC per CT	25 PC per CT	25 PC per CT	25 PC per CT

Safety Helmets

uvex pheos E · uvex pheos E-WR · uvex pheos E-S-WR



uvex pheos E · uvex pheos E-WR

- safety helmet with slots for uvex visors, earmuffs and lamps
- side Euroslot adapters (30 mm) for attaching earmuffs
- suitable for use by electricians as helmet shell is fully enclosed
- meets standard EN 397 and additional requirements for very low temperatures (-30 °C) and molten metal (MM) splash and is approved in accordance with EN 50365 (1000 V AC)
- conventional suspension harness for comfortable adjustable fit (uvex pheos E)
- suspension harness with wheel ratchet for variable width adjustment (uvex pheos E-WR)
- fitted with the 9760005 (uvex pheos E) or 9760009 (uvex pheos E-WR) sweatband
- six-point textile band attachment ensures optimal fit and comfort

uvex pheos E with conventional suspension harness		
Art. no.	9770020	9770120
Colour	white	yellow
Version	with long brim	with long brim
Material	HDPE	HDPE
Standard	EN 397	EN 397
	-30 °C, MM	-30 °C, MM
	EN 50365, 1000 V AC	EN 50365, 1000 V AC
Sizes	51 to 61 cm	51 to 61 cm
Order unit	PC	PC
Outer packaging	25 PC per CT	25 PC per CT

uvex pheos E-WR with wheel ratchet system							
Art. no.	9770030	9770130	9770230	9770330	9770430	9770530	9770830
Colour	white	yellow	orange	red	green	blue	dark grey
Version	with long brim	with long brim	with long brim	with long brim	with long brim	with long brim	with long brim
Material	HDPE	HDPE	HDPE	HDPE	HDPE	HDPE	HDPE
Standard	EN 397	EN 397	EN 397	EN 397	EN 397	EN 397	EN 397
	-30 °C, MM	-30 °C, MM	-30 °C, MM	-30 °C, MM	-30 °C, MM	-30 °C, MM	-30 °C, MM
	EN 50365, 1000 V AC	EN 50365, 1000 V AC	EN 50365, 1000 V AC	EN 50365, 1000 V AC	EN 50365, 1000 V AC	EN 50365, 1000 V AC	EN 50365, 1000 V AC
Sizes	52 to 61 cm	52 to 61 cm	52 to 61 cm	52 to 61 cm	52 to 61 cm	52 to 61 cm	52 to 61 cm
Order unit	PC	PC	PC	PC	PC	PC	PC
Outer packaging	25 PC per CT	25 PC per CT	25 PC per CT	25 PC per CT	25 PC per CT	25 PC per CT	25 PC per CT



uvex pheos E-S-WR

- safety helmet with slots for uvex visors, earmuffs and lamps
- side Euroslot adapters (30 mm) for attaching earmuffs
- suitable for use by electricians as helmet shell is fully enclosed
- meets standard EN 397 and additional requirements for very low temperatures (-30 °C) and molten metal (MM) splash and is approved in accordance with EN 50365 (1000 V AC)
- suspension harness with wheel ratchet for variable width adjustment
- fitted with the 9760009 sweatband
- shorter brim for a wider field of upward vision
- six-point textile band attachment ensures optimal fit and comfort

uvex pheos E-S-WR with wheel ratchet system								
Art. no.	9770031	9770131	9770231	9770331	9770431	9770531	9770832	9770931
Colour	white	yellow	orange	red	green	blue	dark grey	black
Version	with short brim	with short brim	with short brim	with short brim	with short brim	with short brim	with short brim	with short brim
Material	HDPE	HDPE	HDPE	HDPE	HDPE	HDPE	HDPE	HDPE
Standard	EN 397	EN 397	EN 397	EN 397	EN 397	EN 397	EN 397	EN 397
	-30 °C, MM	-30 °C, MM	-30 °C, MM	-30 °C, MM	-30 °C, MM	-30 °C, MM	-30 °C, MM	-30 °C, MM
	EN 50365	EN 50365	EN 50365	EN 50365	EN 50365	EN 50365	EN 50365	EN 50365
	1000 V AC	1000 V AC	1000 V AC	1000 V AC	1000 V AC	1000 V AC	1000 V AC	1000 V AC
Sizes	52 to 61 cm	52 to 61 cm	52 to 61 cm	52 to 61 cm	52 to 61 cm	52 to 61 cm	52 to 61 cm	52 to 61 cm
Order unit	PC	PC	PC	PC	PC	PC	PC	PC
Outer packaging	25 PC per CT	25 PC per CT	25 PC per CT	25 PC per CT	25 PC per CT	25 PC per CT	25 PC per CT	25 PC per CT



Safety Helmets

uvex pheos IES · uvex pheos S-KR · reflex set



uvex pheos IES

- safety helmet with slots for uvex visors, earmuffs, lamps and Integrated Eyewear System (IES)
- side Euroslot adapters (30 mm) for attaching earmuffs
- meets standard EN 397 and additional requirements for very low temperatures (-30 °C) and molten metal (MM) splash
- three variable air vents for maximum ventilation
- suspension harness with wheel ratchet for variable width adjustment – also has the option to mount uvex pheos, uvex pheos or uvex i-works safety spectacles
- fitted with the 9760007 sweatband
- six-point textile band attachment ensures optimal fit and comfort

uvex pheos IES with wheel ratchet system					
Art. no.	9772040	9772140	9772240	9772340	9772540
Colour	white	yellow	orange	red	blue
Version	with long brim				
Material	HDPE	HDPE	HDPE	HDPE	HDPE
Standard	EN 397	EN 397	EN 397	EN 397	EN 397
	-30 °C, MM	-30 °C, MM	-30 °C, MM	-30 °C, MM	-30 °C, MM
Sizes	55 to 61 cm	55 to 61 cm	55 to 61 cm	55 to 61 cm	55 to 61 cm
Order unit	PC	PC	PC	PC	PC
Outer packaging	25 PC per CT	25 PC per CT	25 PC per CT	25 PC per CT	25 PC per CT

MADE IN GERMANY



uvex pheos S-KR

- safety helmet with slots for uvex visors, helmet earmuffs and helmet torches
- side Euroslot adapters (30 mm) for attaching earmuffs
- three adjustable air vents for maximum ventilation
- fitted with the sweatband 9760005
- suspension harness with wheel ratchet system for variable width adjustment
- six-point textile band attachment ensures excellent fit and comfort
- pre-fitted four-point forked chin strap
- attachment clip (9790022) for positioning the forked chin strap in the resting position or as a holder for goggles
- products that are eligible according to BG-Bau (German employer's liability insurance association for the construction industry) are available on request

uvex pheos S-KR					
Art. no.	9772034	9772134	9772234	9772335	9772534
Colour	white	yellow	orange	red	blue
Version	with short brim				
Material	HDPE	HDPE	HDPE	HDPE	HDPE
Standard	EN 397	EN 397	EN 397	EN 397	EN 397
	-30 °C, MM	-30 °C, MM	-30 °C, MM	-30 °C, MM	-30 °C, MM
Sizes	52 to 61 cm	52 to 61 cm	52 to 61 cm	52 to 61 cm	52 to 61 cm
Order unit	PC	PC	PC	PC	PC
Outer packaging	25 PC per CT	25 PC per CT	25 PC per CT	25 PC per CT	25 PC per CT

MADE IN GERMANY



uvex pheos reflex set L

- safety helmet with highly reflective sticker set
- helmets are delivered with the stickers already applied



uvex pheos reflex set L
(select preferred helmet colour)

uvex pheos reflex set L					
Art. no.	Colour	Version	Art. no.	Colour	Version
9772026	white	uvex pheos B with reflective sticker	9772038	white	uvex pheos B-S-WR with reflective sticker
9772126	yellow	uvex pheos B with reflective sticker	9772137	yellow	uvex pheos B-S-WR with reflective sticker
9772226	orange	uvex pheos B with reflective sticker	9772239	orange	uvex pheos B-S-WR with reflective sticker
9772326	red	uvex pheos B with reflective sticker	9772334	red	uvex pheos B-S-WR with reflective sticker
9772526	blue	uvex pheos B with reflective sticker	9772537	blue	uvex pheos B-S-WR with reflective sticker
9772926	black	uvex pheos B with reflective sticker	9770026	white	uvex pheos E with reflective sticker
9772035	white	uvex pheos B-WR with reflective sticker	9770126	yellow	uvex pheos E with reflective sticker
9772138	yellow	uvex pheos B-WR with reflective sticker	9770036	white	uvex pheos E-WR with reflective sticker
9772236	orange	uvex pheos B-WR with reflective sticker	9770136	yellow	uvex pheos E-WR with reflective sticker
9772437	green	uvex pheos B-WR with reflective sticker	9770536	blue	uvex pheos E-WR with reflective sticker
9772538	blue	uvex pheos B-WR with reflective sticker			
9772936	black	uvex pheos B-WR with reflective sticker			

Order quantity multiples/ 25 PC
Order unit

▶ Please contact our service hotline free of charge on **+49 911 9736-0**.

Safety Helmets Accessories



9790065
with safety helmet
(helmet not included)



9790075
with safety helmet
(helmet not included)



9790076
with safety helmet
(helmet not included)



9790068



9790066



9790086
with safety helmet
(helmet not included)



9790086

uvex winter cap

- winter cap for use in all uvex helmets
- windproof and waterproof outer material
- all-around reflective strip
- side mesh to increase the wearer's attention to environmental influences (ear area)
- warming fleece lining

uvex balaclava

- uvex balaclava is the ideal addition to the winter cap – with continuous size adjustment through hinged Velcro fastening

uvex neck protection

- uvex neck protection for protection against rain, dust, splinters and solar radiation
- for use with all uvex helmets
- fitted with mount 9790022 to attach the neck protection in the uvex pheos helmet shell

uvex cooling neck protection

- with unique cooling function – up to 8 hours cooling effect, protection from sunlight

	uvex winter cap	uvex balaclava	uvex neck protection	uvex cooling neck protection
Art. no.	9790065	9790068	9790075	9790086
Version	100% polyester	100% polyester	100% polyester	100% polyester
Colour	hi-viz yellow	hi-viz orange	orange	yellow
Sizes	unisize	unisize	unisize	unisize
Order unit	PC	PC	PC	PC



9790006



9790010



9790015



9790016



9790012

Hygienic caps · Winter caps

	Hygienic cap	Winter caps			
Art. no.	9790006	9790010	9790015	9790016	9790012
Version	100% fleece	50% cotton	50% cotton	60% polyester, 30% wool	60% polyester, 30% wool
		50% wool	50% virgin wool	8% nylon, 2% elastane	8% nylon, 2% elastane
Colour	white	navy blue	black	black	navy blue
Sizes	unisize	unisize	S to M	L to XL	unisize
Order unit	80 PC	PC	PC	PC	PC

Safety Helmets

Accessories



9790000

9790004



9772001

9760007



9760012

9760011



9760009

9760014

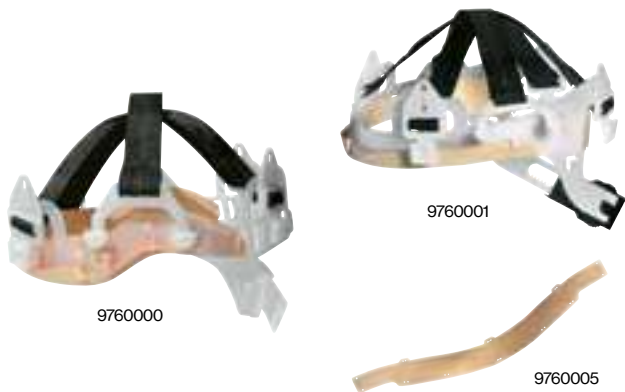

9760000

9760001

9760005

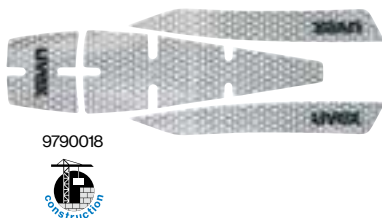

9790018

Accessories for uvex super boss and uvex thermo boss

	Suspension harness for uvex super boss and uvex thermo boss	Sweatband for uvex super boss and uvex thermo boss
Art. no.	9790000	9790004
Version	Six-point textile attachment with sweatband	Artificial leather (leatherette)
Order unit	PC	10 PC

Accessories for uvex pheos IES

	Suspension harness for IES For uvex pheos (Not pheos E and pheos alpine)	Sweatband for pheos IES
Art. no.	9772001	9760007
Version	Six-point textile suspension with textile sweatband with uvex pheos glasses clip	textile/foam material
Order unit	PC	10 PC

Accessories for uvex pheos E-WR and uvex pheos alpine

	Suspension harness for uvex pheos E-WR	Suspension harness for uvex pheos alpine
Art. no.	9760012	9760011
Version	Six-point textile attachment with sweatband	Six-point textile attachment with sweatband
Order unit	PC	PC
	Sweatband for uvex pheos alpine and uvex pheos E-WR	Wheel ratchet padding
Art. no.	9760009	9760014
Version	PU, leather	polyester
Order unit	10 PC	10 PC

Accessories for uvex pheos and uvex airwing

	Conventional suspension harness for uvex pheos and uvex airwing	Suspension harness for uvex pheos and uvex airwing (not for uvex pheos E) with wheel ratchet
Art. no.	9760000	9760001
Version	Six-point textile attachment with sweatband	Six-point textile attachment with sweatband
Order unit	PC	PC
	Sweatband for uvex pheos, uvex airwing and uvex pheos alpine	
Art. no.	9760005	
Version	Artificial leather (leatherette) with sweatband	
Order unit	10 PC	

uvex pheos reflex set M

- highly reflective sticker set
- extremely high brightness with prism film
- easy to affix
- suitable for all uvex pheos and uvex pheos alpine safety helmets

	uvex pheos reflex set M
Art. no.	9790018
Order unit	PC

Safety Helmets

Accessories

Accessories for uvex pheos, uvex pheos alpine, uvex airwing, uvex super boss and uvex thermo boss



9790077



9790153

	Leather chin straps for uvex pheos (not for pheos IES and pheos E), uvex pheos alpine, uvex airwing, uvex superboss and uvex thermo boss	
Art. no.	9790005	
Version	Robust leather design with plastic eyelets with metal rivets, Adjustable length	
Order unit	PC	
	Forked chin straps for uvex airwing	Leather chin strap for uvex pheos (not uvex pheos alpine)
Art. no.	9790007	9790035
Version	textile band with push-button quick-action fastener plastic eyelets and chin pad, length can be adjusted	Robust leather design with plastic eyelets with metal rivets, length can be adjusted
Order unit	PC	PC
	Forked chin straps for uvex pheos and uvex pheos E (not for uvex pheos alpine)	
Art. no.	9790021	
Version	Textile strap with quick-release push-button fastening, plastic hooks and chin pad, adjustable length	
Order unit	PC	
	IES mount with sliding element for uvex pheos IES System	Penholder for uvex pheos and uvex pheos E
Art. no.	9772002	9790023
Version	plastic	plastic
Order unit	PC	PC
	Goggles clip for uvex pheos/ chin strap clip for uvex pheos alpine	
Art. no.	9790022	
Version	Plastic clip for fixing the goggles band or the chin strap on the helmet	
Order unit	PC	
	uvex spiderneck neck support	
Art. no.	9790149	
Version	Kunststoffclip zur Fixierung des Vollsichtbrillenbandes bzw. des Kinnriemens am Helm for use with the uvex pheos alpine increases neck support, improves comfort, improved weight distribution across the helmet easy installation: is threaded over the wheel ratchet	
Order unit	PC	
	Business card holder	
Art. no.	9790166	
Content	10 holders + 20 PVC cards	
Order quantity multiples	10 PC	
	uvex helmet bag for storing and transporting the uvex safety helmet	Helmet slot sealing plug set
Art. no.	9790071	9790077
Version	polyester	plastic
Order unit	PC	PC



uvex pheos helmet sticker

- ideal for identifying different trades
- durable and weather-resistant high-performance PVC film

uvex pheos helmet sticker							
Art. no.	9790150	9790151	9790152	9790153	9790154	9790155	9790156
Colour	silver	yellow	orange	red	green	blue	black
Material	PVC film	PVC film	PVC film	PVC film	PVC film	PVC film	PVC film
Order unit	PC	PC	PC	PC	PC	PC	PC

Safety Helmets

Accessories: Head torchs

► All uvex LED head torches fit into the front slot of the uvex pheos, uvex pheos alpine.

9790062
9790063



9790029



9790064



uvex head torch pheos Lights · pheos Lights EX

- LED helmet torch with two separate reflectors for distance and area lighting
- compact design, very low weight (80 g), extremely robust
- power source: 1.7 Ah-Li-Ion battery
- illuminance: max. 6500 lux
- operating temperature: -20 °C to + 60 °C
- charge adapter and micro-USB charger included
- protection class IP 67 (dust-tight and waterproof)
- 9790063: ATEX certification II 2G Ex ib IIC T4

Press switch	Modes	Lumen	Range	Light duration
Area light	low	55	5 m	11 h
	high	115	10 m	5.5 h
Distance light	low	55	50 m	11 h
	high	115	100 m	5.5 h

KS-6002-DUO

- LED helmet torch with two separate precision lenses for distance and area lighting
- compact design
- Beam can be infinitely adjusted to suit the area to be lit
- power source: lithium-Ion battery, 3.7 V, 1.7 Ah
- illuminance: max. 8500 lux
- operating temperature: -20°C to +60°C
- protection class: IP 67 (dust-tight and waterproof)
- charger included
- charging time: approx. 5 hours

Press switch	Modes	Lumen	Range	Light duration
Area light	normal	80	5 m	11 h
	strong	200	10 m	4 h
Distance light	normal	80	80 m	11 h
	strong	160	180 m	5.5 h

LED head torch u-cap sport · uvex pheos helmet adapter

- LED head torch with two separate reflectors for distance and area lighting
- sturdy design, with very low weight (55 g without batteries)
- power source: 3 x AAA batteries (not included)
- illuminance: approx. 4000 lux
- operating temperature: -20 °C to +45 °C
- protection class IP 66 (complete protection against dust and powerful water jets)
- Adapter for the LED head torch u-cap sport for combining with the uvex pheos and uvex pheos alpine helmets

Press switch for 1 s	Modes	Lumen	Range	Light duration
Area light	high	30	7 m	80 h
	low	10	3 m	150 h
	medium	40	80 m	70 h
Distance light	high	100	110 m	30 h
	low	5	10 m	150 h

Art. no.	LED head torch pheos Lights	LED head torch pheos Lights EX	LED head torch KS-6002-DUO	LED head torch uvex u-cap sport	uvex pheos helmet adapter
9790062	9790062	9790063	9790029	9790064	9790069
Version	for uvex pheos helmets	for uvex pheos helmets – ATEX	for uvex pheos helmets	for uvex u-cap sport	for LED head torch uvex u-cap sport for combining with the uvex pheos and uvex pheos alpine helmets
Order unit	PC	PC	PC	PC	PC

9790028



9790213



9790214



KS-7630-MCII

- compact design
- protection class IP 67 (dust-tight and waterproof)
- operating temperature -15°C to 50°C
- power source: lithium-ion battery
- charging time: approx. 9 hours
- >80% capacity after 500 charging cycles
- ATEX approval (Directive 2014/34/EU)

Mode	Lumen	Strength**	Range	Light duration
Emergency light	70 lm	≥ 3000 lx	80 m	≥ 30 h
Work light	180 lm	≥ 5500 lx	140 m	≥ 14 h
Strong light*	230 lm	≥ 10000 lx	190 m	≥ 6 h

Art. no.	KS-7630-MCII
9790028	9790028
Version	for uvex pheos helmets
Order unit	PC

Suprabeam V3air rechargeable · Universal silicone strap for Suprabeam V3air rechargeable

- LED head torch with sliding focus for distance and area lighting
- can be dimmed between 180 and 8 lumens
- robust design with low weight (148 g); weight balanced by battery at the rear
- power source: 1.4-Ah LiPo battery
- luminous flux: up to max. 320 lumen
- light duration: max. 100 hours
- operating temperature: -20°C to +50°C
- IPX4 protection (protection against splashing water from all directions)
- highly adjustable angle: illuminates an area in the distance or directly in front of the wearer
- range up to 210 metres
- 9790214: for attachment to all uvex protective helmets
- 9790214: prevents lamp from slipping off helmet

Art. no.	Suprabeam V3air rechargeable	Universal silicone strap
9790213	9790213	9790214
Version	with headband; suitable for all uvex helmets with article 9790214	for V3air rechargeable
Order unit	PC	PC



Visors and face protection

Visor lenses, certification and norms

The right solution for every requirement



Polycarbonate lenses with uvex supravision excellence coating

Polycarbonate has a high mechanical impact strength. Coated lenses are anti-fog on the inside, and scratch- and chemical-resistant on the outside. The anti-fogging properties are permanent even after repeated cleaning. The lenses are especially easy to clean and less susceptible to dirt due to the non-stick nanotechnology.

Cellulose acetate lenses

Face protection visors made of cellulose acetate are ideally suited for protection against chemicals.

Stainless steel mesh

is robust and has excellent stability and long life. Stainless steel mesh visors offer a higher light transmission than nylon mesh visors and are used for more rugged work in agriculture and forestry.

Standards at a glance

EN 166 – Personal eye protection

The European standard EN166 applies to all types of eye protection. EN 166 visors are made of frames and lenses.

Certification according to DIN EN 166

Marking on frame

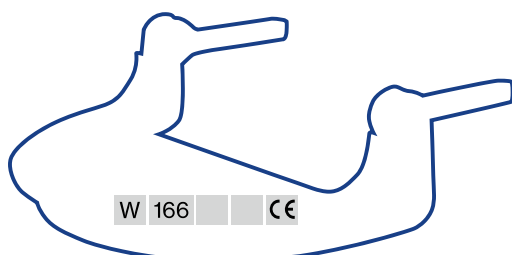

Marking on lenses

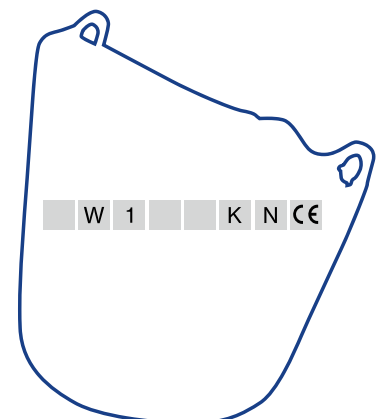

A detailed description of frame and lens markings can be found on page 25.

Labelling and norms

EN 170 – Ultraviolet protection filters

In the standards for special product requirements, the standard EN 170 sets out levels of protection and transmission requirements for ultraviolet protection filters. Excessive exposure to ultraviolet light can cause the lens of the eye to lose its transparency, which may cause

visual impairment or loss of vision. Visor lenses in accordance with EN 170 therefore meet performance requirements to protect the eye from ultraviolet radiation during hazardous work.

EN 1731 – Mesh face protection

The European standard EN 1731 describes all requirements for personal eye and face protection made of mesh material. EN 1731 visors consist of frames and lenses.

Technical information on the frame and the lens are specified according to EN 1731 in the following order:

- Identification of the manufacturer
- Number of European standard
- Symbol for mechanical strength

Mechanical strength	
none	without mechanical strength (filters only)
S	increased strength (filters only)
F	low energy impact (45m/s)
B	medium energy impact (120m/s)
A	high energy impact (190 m/s)
T	tested at extreme temperatures (-5°C and +55°C)



GS-ET 29

When working on energised electrical systems and equipment, the risk of a short circuit electric arc must be assessed. Short circuit electric arcs are usually caused by a short circuit between the electrical lines. The GS-ET 29 test principle is an additional requirement for the testing and certification of electrician face protection. These visors are a category 3 product, which means there is a risk of physical injury and

death. With regards to different intensities of short circuit electric arcs, the certified products must be assessed for their suitability for the respective application. Here, there are distinctions between two classes, Class 1 – up to 4 kA – and Class 2, up to 7 kA.

Certification according to GS-ET 29

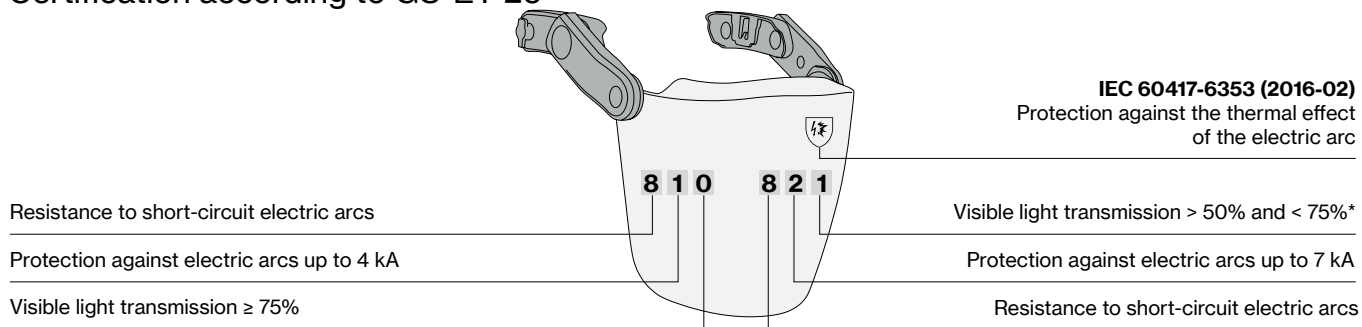

Previously



According to 7 kA short circuit electric arc

*It is obligatory to use an additional illumination, to reach a minimum illuminance of 30 lux behind the faceshield.

Visors and face protection

uvex pheos visor system

uvex pheos visor

- polycarbonate visors with uvex supravision excellence coating technology
- visor is anti-fog on the inside and exceptionally scratch- and chemical-resistant on the outside. The anti-fogging properties are permanent, even after repeated cleaning
- easy to clean thanks to non-stick nanotechnology
- available with two mounting options: mechanical levers or automatic magnetic locks
- visors 9906002, 9906003 and 9906009 can be combined with the industrial protection helmets:
 - uvex pheos B-S-WR
 - Helmet for working at height uvex pheos alpine (visor adapter art. no. 9790067 required)
- visors uvex pheos SLB 1 (9906005 and 9906006) and uvex pheos SLB 2 (9906007 and 9906008) can be combined with the uvex pheos E-S-WR industrial safety helmet
- lenses can be changed
- fulfils standards EN 166 and EN 170
- certified for areas of application 3 (liquids) and 9 (molten metal and hot solids)
- uvex pheos SLB 1 visors are certified in accordance with GS-ET 29 as Class 1 visors for protection from electrical arcs (4kA)
- uvex pheos SLB 2 visors are certified in accordance with GS-ET 29 as Class 2 visors for protection from electrical arcs (7kA)
- you can find the combination options on the next page (page 138)

Perfect 'resting position' for the visor and hearing protection

The visor can be locked above the helmet shell when not required and the hearing protection can be folded back. Everything fits closely to the helmet and is perfectly balanced over the body's centre of gravity. This

means the neck muscles are not placed under strain by any unnecessary weight, ensuring excellent wearer comfort and maximum freedom of movement.

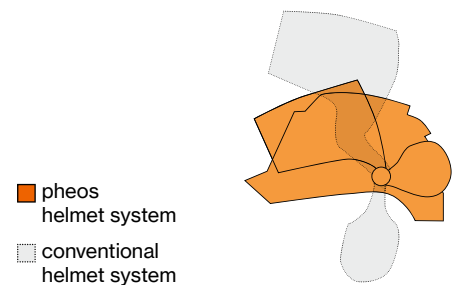

Reliable face protection

The anti-fog and scratch-resistant visor is made of high-quality polycarbonate that meet the highest optical quality class. The visor fits the helmet seamlessly, leaving no gaps.

The injection-moulded transparent peak provides protection against any particles penetrating the inside of the visor.



Magnetic and mechanical locking system

All visors are pre-assembled with a helmet adapter. This is clicked into the side helmet slot and remains permanently attached there.

With the magnetic locking system, the attachment parts, visor and earmuffs can be removed easily at any time without having to remove the helmet. The visor is released with a click of the lateral locking system. When re-assembled, the parts automatically snap back

into place. This allows the helmet to remain comfortably on your head.

If the product is equipped with a mechanical locking system, the earmuffs can be removed at any time via a bayonet connection. The mechanical visor remains permanently attached to the helmet.



Magnetic
locking system for visors and earmuffs with a magnetic connection



Mechanical
locking system for visors and earmuffs with a bayonet connection



Visors and face protection

uvex pheos visor system



9906002
9906005



9906007



9906003
9906006



9906008



9906009











Art. no.	uvex pheos 9906002	uvex pheos SLB 1 9906005	uvex pheos SLB 2 9906007
Version	uvex supravision excellence with mechanical levers and bayonet connection for hearing protection	uvex supravision excellence certified as Class 1 visor for protection from electrical arcs, with mechanical levers and bayonet connection for hearing protection	uvex supravision excellence certified as Class 2 visor for protection from electrical arcs with mechanical levers and chin protection and bayonet connection for hearing protection
Standard Frame	EN 166, EN 170 black W 166 3 8-2 9 B CE 0196	EN 166, EN 170 black W 166 3 8-2 9 B CE 0196	EN 166, EN 170 black W 166 3 8-2 9 B CE 0196
Lens	PC clear UV 400 2C-1.2 W 1 B 9 KN CE 0196	PC clear UV 400 2C-1.2 W 1 B 8-1-0 9 KN CE 0196	PC blue UV 400 2C-1.2 W 1 B 8-2-0 9 KN CE 0196
Order unit	PC, individually packed in polythene bags	PC, individually packed in polythene bags	PC, individually packed in polythene bags
Outer packaging	24 PC per CT	24 PC per CT	14 PC per CT
Replacement lens	9906013, individually packed in polythene bags	9906012, individually packed in polythene bags	9906017, individually packed in polythene bags

Art. no.	uvex pheos magnetic 9906003	uvex pheos SLB 1 magnetic 9906006	uvex pheos SLB 2 magnetic 9906008	uvex pheos magnetic with chin guard 9906009
Version	uvex supravision excellence with magnetic levers	uvex supravision excellence certified as Class 1 visor for protection from electrical arcs, with magnetic levers	uvex supravision excellence certified as Class 2 visor for protection from electrical arcs with magnetic levers and chin protection	uvex supravision excellence with small chin guard and magnetic lever arms
Standard Frame	EN 166, EN 170 black W 166 3 8-2 9 B CE 0196	EN 166, EN 170 black W 166 3 8-2 9 B CE 0196	EN 166, EN 170 black W 166 3 8-2 9 B CE 0196	EN 166, EN 170 black W 166 3 9 8-2 B CE 0196
Lens	PC clear UV 400 2C-1.2 W 1 B 9 KN CE 0196	PC clear UV 400 2C-1.2 W 1 B 8-1-0 9 KN CE 0196	PC blue UV 400 2C-1.2 W 1 B 8-2-0 9 KN CE 0196	PC clear UV 400 2C - 1,2 W 1 B 9 KN CE
Order unit	PC, individually packed in polythene bags	PC, individually packed in polythene bags	PC, individually packed in polythene bags	PC, individually packed in polythene bags
Outer packaging	20 PC per CT	20 PC per CT	14 PC per CT	20 PC per CT
Replacement lens	9906013, individually packed in polythene bags	9906012, individually packed in polythene bags	9906017, individually packed in polythene bags	9906014, individually packed in polythene bags

Visors and face protection

Combination options and accessories

Combination options uvex pheos visors

	Art. no.	Visor frame	Visor	Protection	Suitable helmets	Earmuffs
	9906002	mechanical	polycarbonate, clear	against mechanical influences (e.g. sparks, splinters)	all uvex pheos helmets with short brim	2600214 
	9906003	magnetic	polycarbonate, clear			
	9906009	magnetic	polycarbonate, clear with chin guard			
	9906005	mechanical	polycarbonate, clear with UV absorber	against electrical arcs up to 4 kA (kiloamperes)	uvex pheos E-S-WR	2600214
	9906006	magnetic	polycarbonate, clear with UV absorber			2600215
	9906007	mechanical	polycarbonate, blue with UV absorber and chin section	against electrical arcs up to 7 kA (kiloamperes)	uvex pheos E-S-WR	2600214
	9906008	magnetic	polycarbonate, blue with UV absorber and chin section			2600215



uvex pheos visor system accessories

	Visor adapter
Art. no.	9790067
Version	for combining with the helmet for working at height uvex pheos alpine for inserting on the inside of the visor's face cover (visor not included)
Order unit	PC, individually packed in polythene bags

	Helmet adapter
Art. no.	9790078
Version	helmet adapter for use with uvex pheos K2P magnet earmuffs (2600215) without visor, is only required if no visor is used
Order unit	PR, individually packed in polythene bags

	Sunglare filter/rain cover
Art. no.	9790074
Version	to protect against sun and rain, for insertion on the inside of the face cover of the visor, cannot be combined with the visors uvex pheos SLB 1 and uvex pheos SLB 2
Order unit	PC, individually packed in polythene bags

	Microfibre case
Art. no.	9954362
Version	cloth bag to store and transport uvex visors and uvex helmets, black
Order unit	PC, loose

Visors and face protection

9790 · 9725 · 9726 · Forestry worker visor



9790048



9790047



9924010

uvex 9790

- robust polycarbonate visor for uvex industrial safety helmets and uvex helmet earmuffs 3200H, K1H and K2H
- for use during electrical work, a suitable electrician's helmet and dielectric helmet earmuffs must be used
- visor lens, helmet bracket and adapter must be ordered as individual parts
- additional adapters (art. no. 9924010) are required for the helmet and visor combination (without helmet earmuffs)

► helmet, helmet bracket and earmuffs are not included.



Lens	
Art. no.	9790048
Version	uncoated
	Short circuit electric arc classification Class 1
	Fixed on helmet bracket 9790047
Standard	EN 166, EN 170, GS-ET 29
Lens	PC clear, UV 400
	2C-1,2 W 1 B 8-1-0 9 CE 0196
Order unit	PC, individually packed in polythene bags
Outer packaging	100 PC per CT

	Helmet bracket	Adapter
Art. no.	9790047	9924010
Version	Helmet bracket for visor 9790 (9790048)	Adapter for attaching without earmuffs
Frame	black	
	W 166 3 8-1 9 B CE 0196	
Order unit	PC, individually packed	PR, individually packed
	in polythene bags	in polythene bags
Outer packaging	90 PC per CT	500 PR per CT

9725514
9726014



uvex 9725 · uvex 9726

- polycarbonate and cellulose acetate visors with adapters for attaching on the side helmet slots
- easy to change lenses
- not combinable with earmuffs
- suitable for helmets uvex airwing and uvex superboss

► Helmet not included!

	9725	9726
Art. no.	9725514	9726014
Replacement lens	9050517	9723017
Version	anti-fog on the inside	uncoated
	Material thickness: 1 mm	Material thickness: 1 mm
Standard	EN 166, EN 170	EN 166, EN 170
Frame	black	black
	W 166 3-F CE	W 166 3-B CE
Lens	CA clear, UV 380	PC clear, UV 400
	2C-1,2 W 1 FN CE	2C-1,2 W 1 B CE
Order unit	PC, individually packed in polythene bags	
Outer packaging	20 PC per CT	20 PC per CT



uvex pheos forestry worker visor

- metal mesh visor for forestry work
- suitable for helmet uvex pheos ABS
- lens certification: W EN 1731:2006-F

Further information can be found on page 125.

uvex pheos faceguard

Face protection system

This innovative face protection system consists of a height- and width-adjustable head strap and a choice of two different visor lenses. The high-quality polycarbonate visor features uvex coating technology to ensure that the wearer's field of vision remains fog-free for a long period of time and that the outside of the visor is scratch-resistant. The mesh visor is made of robust stainless steel and provides reliable protection when working outdoors. The earmuffs can be attached and removed quickly using a rotating mechanism. The system can be expanded with a wide range of accessories and adapted to suit the application.



The uvex multi-system in detail



The benefits of the uvex pheos faceguard at a glance:

- fully pre-assembled face protection system — ready to use at any time
- wide field of vision with the highest optical quality
- robust polycarbonate visor with anti-fog and scratch-resistant uvex supervision excellence coating or stainless steel mesh visor
- low weight and balanced centre of gravity to relieve the spine
- expandable system with high modularity
- unique combination: visor and bump cap
- replaceable individual parts
- comfortable fit even with glasses and respirators



Further information can be found at uvex-safety.com/en/pheosfaceguard (or scan the QR code).

uvex pheos faceguard

Face protection system

Designed to protect the face and neck

The uvex pheos faceguard has been ergonomically designed. The face protection system has been designed to evenly distribute the weight across the body's centre of gravity. The low weight and ergonomic centre of gravity supports a natural head posture, minimising strain on the neck and back. The narrow design and wide field of vision help to support the natural posture of the head and neck.



9790211



9790212



9790215

	uvex pheos faceguard	uvex pheos faceguard with hearing protection	uvex pheos faceguard mesh visor with hearing protection
Art. no.	9790211	9790212	9790215
Version	Pre-assembled system for head sizes 52–64 cm, Polycarbonate lens, uvex supravision excellence coating, Without hearing protection	Pre-assembled system for head sizes 52–64 cm, Polycarbonate lens, uvex supravision excellence coating, With earmuffs K1P (SNR: 28 dB), further information can be found on page 107	Pre-assembled system for head sizes 52–64 cm stainless steel mesh visor with high light transmission with hearing protectors K1P (SNR: 28 dB), further information can be found on page 107
Standard	EN 166, EN 170	EN 166, EN 170, EN 352	EN 1731
Frame	W 166 39B CE	W 166 39B CE	W EN 1731:2006 F CE
Lens	PC, clear, UV 400 2C-1.2 W 1 B 9 KN CE 0196	PC, clear, UV 400 2C-1.2 W 1 B 9 KN CE 0196	Stainless steel mesh visor, light transmission > 60% W EN 1731:2006 F CE
Order unit	PC, individually packed in CT	PC, individually packed in CT	PC, individually packed in CT

Accessories



9760107

9760108



9906013



9790074



2600216



9790159



9790160



9790170

	replacement suspension harness	replacement sweatband	replacement lens visor	sun protection	hearing protection earplugs K1P	uvex pheos faceguard bump cap	Replacement lens	Sun/Neck protection
Art. no.	9760107	9760108	9906013	9790074	2600216	9790159	9790160	9790170
Version	Plastic suspension harness for head sizes 52–64 cm	Textile	Polycarbonate lens uvex supravision excellence coating	Protects against sun and rain is inserted on the visor	Earmuffs for uvex pheos faceguard SNR 28 dB	Bump cap for the uvex pheos faceguard system, hard shell ABS, black, 52–64 cm EN 812	stainless steel mesh visor for uvex pheos faceguard	Textile with cooling function to protect against sunlight
Order unit	PC, individually packed in polythene bags	PC, individually packed in polythene bags	PC, individually packed in polythene bags	PC, individually packed in polythene bags	PR, in pairs in CT	PC, individually packed in polythene bags	PC, individually packed in polythene bags	PC, individually packed in polythene bags

Safety Helmets

uvex Visors · safety Goggles



9705014



9706514



9707014



9708514

uvex 9705 · uvex 9706

- cellulose acetate visor with integrated forehead cover
- easy to change lenses
- cannot be combined with safety helmets
- flip-up mechanism with continuous adjustment
- head size can be easily adjusted using a twist lock

uvex 9707 · uvex 9708

- cellulose acetate visor with integrated fore-head cover and additional protective cap made from impact-resistant polystyrene
- easy to change lenses
- flip-up mechanism with continuous adjustment
- head size can be easily adjusted using a twist lock

	visor 9705	visor 9706	visor 9707	visor 9708
Art. no.	9705014	9706514	9707014	9708514
Version	uncoated	anti-fog on the inside	uncoated	anti-fog on the inside
Standard	EN 166, EN 170	EN 166, EN 170	EN 166, EN 170	EN 166, EN 170
Frame	black	black	black	black
	W166 3-F DIN CE 0196	W166 3-F DIN CE 0196	W166 3 F DIN CE 0196	W166 3 F DIN CE 0196
Lens	CA clear, UV 380	CA clear, UV 380	CA clear, UV 380	CA clear, UV 380
	W 1 F DIN CE	W 1 FN DIN CE	W 1 F DIN CE	W 1 F DIN CE
Order unit	PC, individually packed in polythene bags			
Outer packaging	15 PC per CT	15 PC per CT	10 PC per CT	10 PC per CT
Replacement lens	9060017	9050517	9060017	9050517

Accessories

uvex pheos

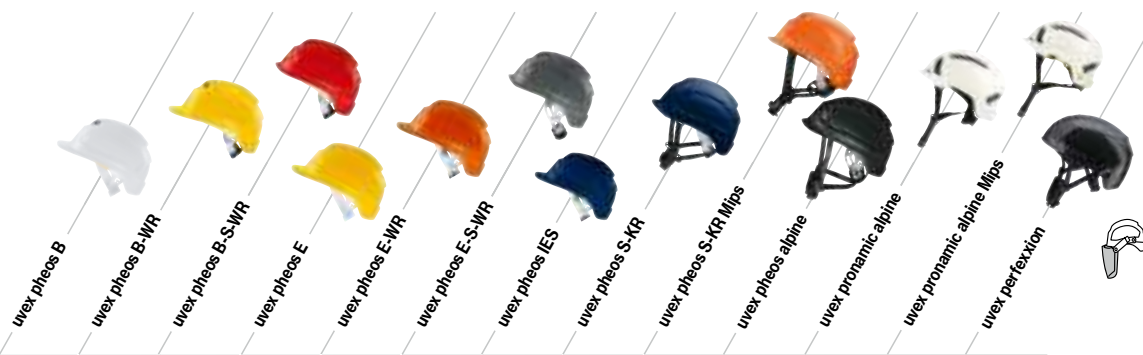

	uvex pheos B	uvex pheos B-WR	uvex pheos B-S-WR	uvex pheos E	uvex pheos E-WR	uvex pheos E-S-WR	uvex pheos IES	uvex pheos S-KR	uvex pheos S-KR Mips	uvex pheos alpine	uvex pronamic alpine	uvex pronamic alpine Mips	uvex perfixion
9760000	Conventional suspension harness	■	■	■	■	■	■	■	■	-	-	-	-
9760001	Suspension harness with rotating size adjusters	■	■	■	-	-	■	■	■	-	-	-	-
9760011	Suspension harness for pheos alpine	-	-	-	-	-	-	-	-	■	-	-	-
9760012	Suspension harness for uvex pheos E-WR	■	■	■	■	■	■	■	■	-	-	-	-
9772001	Suspension harness IES	■	■	■	-	-	■	■	-	-	-	-	-
9760009	Sweatband uvex pheos alpine and uvex pheos E-WR	■	■	■	■	■	■	■	-	■	-	-	-
9760007	Sweatband IES	-	-	-	-	-	■	-	-	-	-	-	-
9760005	Sweatband, synthetic leather	■	■	■	■	■	-	■	-	-	-	-	-
9760260	Sweatband pheos S-KR Mips	■	■	■	■	■	-	■	■	-	-	-	-
9790350	Hygiene kit pronamic alpine	-	-	-	-	-	-	-	-	-	■	-	-
9790352	MIPS hygiene kit pronamic alpine	-	-	-	-	-	-	-	-	-	-	■	-
9790109	Hygiene kit perfixion	-	-	-	-	-	-	-	-	-	-	-	■
9790035	Leather chin straps IES	■	■	■	-	-	■	■	-	-	■	■	-
9790005	Leather chin straps	■	■	■	-	-	-	■	-	■	-	-	-
9790021	Forked chin straps	■	■	■	■	■	■	■	■	-	■	■	-
9790351	Forked chin strap EN 12492 pronamic alpine	-	-	-	-	-	-	-	-	-	■	■	-
9790023	Pen holder	■	■	■	■	■	■	■	■	-	-	-	-
9772002	Mount	-	-	-	-	-	■	-	-	-	-	-	-
9790022	Goggles clip, chin strap clip	■	■	■	■	■	■	■	■	■	■	■	-
9790065	Winter cap, hi-viz yellow	■	■	■	■	■	■	■	■	■	■	■	-
9790066	Balaclava	■	■	■	■	■	■	■	■	■	■	■	-
9790068	Winter cap, hi-viz orange	■	■	■	■	■	■	■	■	■	■	■	-
9790075	Neck protection, orange	■	■	■	■	■	■	■	■	■	■	■	-
9790076	Neck protection, yellow	■	■	■	■	■	■	■	■	■	■	■	-
9790086	uvex cooling neck protection	■	■	■	■	■	■	■	■	■	■	■	-
9790166	Business card holder	■	■	■	■	■	■	■	■	■	■	■	-
9790018	uvex pheos reflex set M	■	■	■	■	■	■	■	■	■	■	■	-
9790151-9790156	uvex pheos helmet sticker	■	■	■	■	■	■	■	■	-	-	-	-
9906002	uvex pheos visor	-	-	-	-	■	-	■	■	■	-	-	-
9906003	uvex pheos visor SLB1	-	-	-	-	-	-	-	-	-	-	-	-
9906005	uvex pheos visor SLB2	-	-	-	-	-	-	-	-	-	-	-	-
9906007	uvex pheos visor SLB2	-	-	-	-	-	-	-	-	-	-	-	-
2600201	uvex K1H/ uvex K2H	■	■	■	-	-	-	■	■	■	■	■	■
2600202	uvex K10H/ uvex K20H/ uvex K30H	■	■	■	■	■	■	■	■	■	■	■	■
2630210	uvex K10H/ uvex K20H/ uvex K30H	■	■	■	■	■	■	■	■	■	■	■	■
2630220	uvex K10H/ uvex K20H/ uvex K30H	■	■	■	■	■	■	■	■	■	■	■	■
2630230	uvex K10H/ uvex K20H/ uvex K30H	■	■	■	■	■	■	■	■	■	■	■	■
2600214	uvex K1P/ uvex K2P	■	■	■	■	■	■	■	■	■	■	■	-
2600215	uvex K1P/ uvex K2P	■	■	■	■	■	■	■	■	■	■	■	-
2600216	uvex K1P/ uvex K2P	■	■	■	■	■	■	■	■	■	■	■	-
9790078	Helmet adapter magnet	■	■	■	■	■	■	■	■	■	■	■	-
9790062	LED head torch pheos Lights	■	■	■	-	-	-	■	■	■	■	■	-
9790063	LED head torch pheos Lights EX	■	■	■	-	-	-	■	■	■	■	■	-
9790028	LED head torch KS-7630MCII	■	■	■	-	-	-	■	■	■	■	■	-
9790029	LED head torch KS-6001 DUO	■	■	■	-	-	-	■	■	■	■	■	■
9790064	LED head torch u-cap sport	■	■	■	■	■	■	■	■	■	■	■	■
9790069	uvex pheos helmet adapter	■	■	■	■	■	■	■	■	■	■	■	■

■ supplied as standard ■ compatible - not compatible

Accessories

uvex airwing · uvex super boss · uvex thermo boss



	uvex airwing B	uvex airwing B-WR	uvex airwing B-S	uvex airwing B-S-WR	uvex super boss	uvex thermo boss
9760000	Conventional suspension harness	■	■	■	-	-
9760001	Suspension harness with rotating size adjusters	■	■	■	-	-
9790000	Suspension harness for uvex super boss / uvex thermo boss	-	-	-	-	■
9760005	Sweatband	■	■	■	■	-
9790004	Sweatband for uvex super boss / uvex thermo boss	-	-	-	-	■
9790005	Leather chin straps	■	■	■	■	■
9790007	Forked chin straps	■	■	■	■	■
9790065	Winter cap, yellow	■	■	■	■	■
9790066	Balaclava	■	■	■	■	■
9790068	Winter cap, orange	■	■	■	■	■
9790075	Neck protection, orange	■	■	■	■	■
9790076	Neck protection, yellow	■	■	■	■	■
9790086	uvex cooling neck protection	■	■	■	■	■
9790047	Helmet bracket uvex 9790	■	■	■	■	-
9790048	Visor lens, PC	■	■	■	■	-
2600201 2600202	uvex K1H/ uvex K2H	■	■	■	■	■
2630210 2630220 2630230	uvex K10H/ uvex K20H/ uvex K30H	■	■	■	■	■

■ supplied as standard

■ compatible

- not compatible



Safety helmets to match your corporate identity

Individual safety helmets

uvex gives you the option to customise all uvex helmets and bump caps so that your employees' equipment matches your corporate identity specifications.

Please contact the uvex service centre with your requests at any time.

Tel. +49 911 9736-0 · Email: Individualisierung@uvex.de

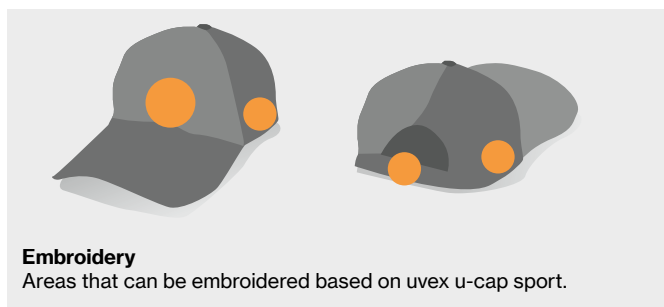
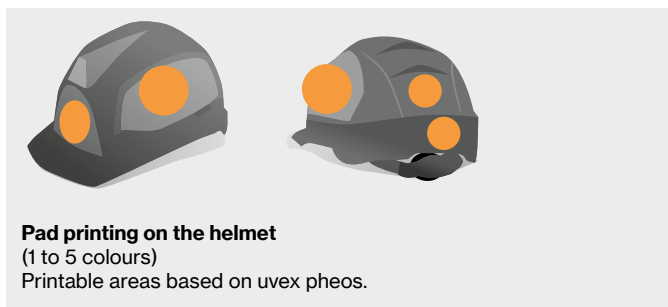

Customisation on the helmet	uvex pheos, uvex airwing, uvex superboss, uvex thermoboss	uvex pheos alpine
Special colour	from 300 units with supplemental charge from 600 units no additional cost	from 600 units no additional cost
new variant:		
– existing colour as a variant, electrician or chemist	from 300 units	
– existing colour with shortened brim	from 100 units	
– existing helmet, other interior, with chin strap	from 25 units	
Finish: Printed, sticker, reflex set	from 25 units reorder quantity: 25 units	

Customisation of bump caps	
Special colour	from 1,000 units
new variant:	
– with existing colour	from 600 units
Finish: Embroidered, printed	from 25 units

- Please note the following conditions:
- minimum order value 25 caps
- reorder quantity: 25 units
- number of colours to be embroidered: up to 14
- textile cap in special colour: from 1000 units
- vector file (.eps, .ai) and image file (.jpg, .pdf) required as template

How individual can you be?

We will be happy to advise you on the technical options for customising our safety helmets.

uvex u-cap sport

Guaranteed head protection with a sporty design

Reliable protection that looks good: uvex u-cap sport is an innovative baseball bump cap in accordance with Norm EN 812. The ergonomically shaped shell with integrated shock-absorbing elements ensures safety and optimal comfort. To give your team a uniform appearance, this model is also available as a standard baseball cap for employees working in environments where head protection is not compulsory.

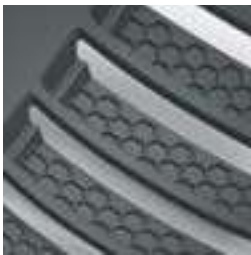

Integrated shock-absorbing elements with honeycomb structure

The specially developed honeycomb structure of the cap with integrated shock-absorbing elements ensures complete protection in accordance with EN 812.



Armadillo design gives flexibility

The armadillo design of the uvex u-cap sport provides additional flexibility and ergonomically adapts to different head shapes and sizes. The extended cut-out near the ear makes it easier to wear earmuffs.



Continuously adjustable

The uvex u-cap sport can be quickly and easily fitted to the head using the adjustable velcro fastening.



Magnetic head torch

- Simple to use: magnetic fixing enables easy attachment and removal from u-cap sport
- The beam can be directed in multiple directions through a moving joint, ensuring optimal illumination
- Switch between various beam types

uvex u-cap sport
A wide range for many applications



LED lamp uvex u-cap sport, suitable for all u-cap sport variants available on page 132.

uvex u-cap sport

uvex u-cap sport						
Art. no.	9794409	9794403	9794404	9794442	9794422	9794424
Version	with short brim (4 cm), hard case made of ABS, textile cap made of cotton			with short brim (4 cm) and mesh webbing suspension harness, hard case made of ABS, textile cap made of cotton		
Standard	EN 812	EN 812	EN 812	EN 812	EN 812	EN 812
Colour	black	black	black	black	black	black
Sizes	52 to 54 cm	55 to 59 cm	60 to 63 cm	52 to 54 cm	55 to 59 cm	60 to 63 cm
Order unit	PC	PC	PC	PC	PC	PC
Outer packaging	60 PC per CT	60 PC per CT	60 PC per CT	60 PC per CT	60 PC per CT	60 PC per CT
Art. no.	9794400	9794401	9794402	9794443	9794423	9794425
Version	with long brim (7 cm), hard case made of ABS, textile cap made of cotton			with long brim (7 cm) and mesh webbing suspension harness, hard case made of ABS, textile cap made of cotton		
Standard	EN 812	EN 812	EN 812	EN 812	EN 812	EN 812
Colour	black	black	black	black	black	black
Sizes	52 to 54 cm	55 to 59 cm	60 to 63 cm	52 to 54 cm	55 to 59 cm	60 to 63 cm
Order unit	PC	PC	PC	PC	PC	PC
Outer packaging	60 PC per CT	60 PC per CT	60 PC per CT	60 PC per CT	60 PC per CT	60 PC per CT

uvex u-cap sport suspension harness

uvex u-cap sport suspension harness	
Art. no.	9794415
Version	soft, comfortable mesh webbing suspension harness increased wearer comfort in uvex u-cap sport bump caps
Standard	EN 812
Colour	black
Sizes	unisize
Order unit	PC
Outer packaging	60 PC per CT

Baseball cap

Baseball cap		
Art. no.	9794110	9794111
Version	with long brim (7 cm) without hard shell element	with short brim (4 cm) without hard shell element
Colour	black	black
Sizes	55 to 63 cm	55 to 63 cm
Order unit	PC	PC
Outer packaging	60 PC per CT	60 PC per CT

uvex u-cap

uvex u-cap sport · uvex u-cap sport vent · uvex u-cap sport hi-viz



9794407
9794408



9794430 9794444
9794420 9794416
9794421 9794417



9794480
9794481
9794482



9794490
9794491
9794492



LED lamp uvex u-cap sport, suitable for all u-cap sport variants available on page 132.

uvex u-cap sport

uvex u-cap sport		
Art. no.	9794407	9794408
Version	with long brim (7 cm), hard case made of ABS, textile cap made of cotton	
Standard	EN 812	EN 812
Colour	navy blue	navy blue
Sizes	55 to 59 cm	60 to 63 cm
Order unit	PC	PC
Outer packaging	60 PC per CT	60 PC per CT

uvex u-cap sport vent

uvex u-cap sport vent			
Art. no.	9794430	9794420	9794421
Version	with short brim (4 cm), hard case made of ABS, textile cap made of cotton and mesh fibre		
Standard	EN 812	EN 812	EN 812
Colour	black	black	black
Sizes	52 to 54 cm	55 to 59 cm	60 to 63 cm
Order unit	PC	PC	PC
Outer packaging	60 PC per CT	60 PC per CT	60 PC per CT
Art. no.	9794444	9794416	9794417
Version	with short brim (4 cm) and mesh webbing and mesh webbing interior, ABS hard shell, textile cap made of cotton and mesh fibre		
Standard	EN 812	EN 812	EN 812
Colour	black	black	black
Sizes	52 to 54 cm	55 to 59 cm	60 to 63 cm
Order unit	PC	PC	PC
Outer packaging	60 PC per CT	60 PC per CT	60 PC per CT

uvex u-cap sport hi-viz

uvex u-cap sport hi-viz						
Art. no.	9794482	9794480	9794481	9794492	9794490	9794491
Version	with short brim (4 cm), ABS hard shell, textile cap made of cotton in fluorescent colours, according to requirements with EN 471 – increased visibility and security for the user					
Standard	EN 812	EN 812	EN 812	EN 812	EN 812	EN 812
Colour	hi-viz yellow	hi-viz yellow	hi-viz yellow	hi-viz orange	hi-viz orange	hi-viz orange
Sizes	52 to 54 cm	55 to 59 cm	60 to 63 cm	52 to 54 cm	55 to 59 cm	60 to 63 cm
Order unit	PC	PC	PC	PC	PC	PC
Outer packaging	60 PC per CT	60 PC per CT	60 PC per CT	60 PC per CT	60 PC per CT	60 PC per CT

Safety Helmets

Overview

Art. no.	Name	Description	Colour	Page	Art. no.	Name	Description	Colour	Page
9050517	Accessories	Replacement lens, CA, non-fogging	clear	139/142	9770130	uvex pheos E-WR	Safety helmet	yellow	127
9060017	Accessories	Replacement lens, CA	clear	142	9770131	uvex pheos E-S-WR	Safety helmet	yellow	127
9705014	Accessories	Cellulose acetate protective visor	clear	142	9770136	uvex pheos E-WR	Safety helmet with reflective sticker	yellow	128
9706514	Accessories	Antifog cellulose acetate protective visor, clear	clear	142	9770230	uvex pheos E-WR	Safety helmet	orange	127
9707014	Accessories	Cellulose acetate protective visor	clear	142	9770231	uvex pheos E-S-WR	Safety helmet	orange	127
9708514	Accessories	Antifog cellulose acetate protective visor, clear	clear	142	9770330	uvex pheos E-WR	Safety helmet	red	127
9720040	uvex perfixxion	Safety helmet	white	121	9770331	uvex pheos E-S-WR	Safety helmet	red	127
9720050	uvex perfixxion	Safety helmet	white	121	9770430	uvex pheos E-WR	Safety helmet	green	127
9720940	uvex perfixxion	Safety helmet	black	121	9770431	uvex pheos E-S-WR	Safety helmet	green	127
9720950	uvex perfixxion	Safety helmet	black	121	9770530	uvex pheos E-WR	Safety helmet	blue	127
9723017	Accessories	Replacement lens, PC	clear	139	9770531	uvex pheos E-S-WR	Safety helmet	blue	127
9725514	Accessories	Antifog cellulose acetate visor	clear	139	9770536	uvex pheos E-WR	Safety helmet with reflective sticker	blue	128
9726014	Accessories	Polycarbonate visor	clear	139	9770830	uvex pheos E-WR	Safety helmet	dark grey	127
9735030	uvex pronamic alpine	Safety helmet	white	115	9770832	uvex pheos E-S-WR	Safety helmet	dark grey	127
9735031	uvex pronamic alpine	Safety helmet	white	115	9770931	uvex pheos E-S-WR	Safety helmet	black	127
9735130	uvex pronamic alpine	Safety helmet	hi-viz yellow	115	9772001	Accessories	Suspension harness IES		130
9735131	uvex pronamic alpine	Safety helmet	hi-viz yellow	115	9772002	Accessories	Mount		131
9735230	uvex pronamic alpine	Safety helmet	hi-viz orange	115	9772020	uvex pheos B	Safety helmet	white	126
9735231	uvex pronamic alpine	Safety helmet	hi-viz orange	115	9772026	uvex pheos B	Safety helmet with reflective sticker	white	128
9750020	uvex super boss	Safety helmet	white	122	9772030	uvex pheos B-WR	Safety helmet	white	126
9750120	uvex super boss	Safety helmet	yellow	122	9772031	uvex pheos B-S-WR	Safety helmet	white	126
9750520	uvex super boss	Safety helmet	blue	122	9772034	uvex pheos S-KR	Safety helmet	white	128
9754000	uvex thermo boss	Safety helmet	white	123	9772035	uvex pheos B-WR	Safety helmet with reflective sticker	white	128
9754100	uvex thermo boss	Safety helmet	yellow	123	9772038	uvex pheos B-S-WR	Safety helmet with reflective sticker	white	128
9754300	uvex thermo boss	Safety helmet	red	123	9772040	uvex pheos IES	Safety helmet	white	128
9760000	Accessories	Conventional suspension harness		130	9772042	uvex pheos planet B-WR	Safety helmet	white	119
9760001	Accessories	Suspension harness with rotating size adjusters		130	9772043	uvex pheos planet B-S-WR	Safety helmet	white	119
9760005	Accessories	Sweatband, synthetic leather		130	9772071	uvex pheos ABS B-S-WR	Safety helmet	white	125
9760007	Accessories	Sweatband, textile/foam material		130	9772120	uvex pheos B	Safety helmet	yellow	126
9760009	Accessories	Sweatband pheos alpine and pheos E-WR		130	9772126	uvex pheos B	Safety helmet with reflective sticker	yellow	128
9760011	Accessories	Suspension harness		130	9772130	uvex pheos B-WR	Safety helmet	yellow	126
9760012	Accessories	Suspension harness		130	9772131	uvex pheos B-S-WR	Safety helmet	yellow	126
9760014	Accessories	Wheel ratchet padding		130	9772134	uvex pheos S-KR	Safety helmet	yellow	128
9760106	Accessories	Replacement suspension harness pheos ABS		125	9772137	uvex pheos B-S-WR	Safety helmet with reflective sticker	yellow	128
9760107	Accessories	Suspension harness pheos faceguard		141	9772138	uvex pheos B-WR	Safety helmet with reflective sticker	yellow	128
9760108	Accessories	Sweatband for suspension harness		141	9772140	uvex pheos IES	Safety helmet	yellow	128
9762020	uvex airwing B	Safety helmet	white	122	9772171	uvex pheos ABS B-S-WR	Safety helmet	yellow	125
9762021	uvex airwing B-S	Safety helmet	white	123	9772220	uvex pheos B	Safety helmet	orange	126
9762030	uvex airwing B-WR	Safety helmet	white	122	9772226	uvex pheos B	Safety helmet with reflective sticker	orange	128
9762031	uvex airwing B-S-WR	Safety helmet	white	123	9772230	uvex pheos B-WR	Safety helmet	orange	126
9762120	uvex airwing B	Safety helmet	yellow	122	9772231	uvex pheos B-S-WR	Safety helmet	orange	126
9762121	uvex airwing B-S	Safety helmet	yellow	123	9772234	uvex pheos S-KR	Safety helmet	orange	128
9762130	uvex airwing B-WR	Safety helmet	yellow	122	9772236	uvex pheos B-WR	Safety helmet with reflective sticker	orange	128
9762131	uvex airwing B-S-WR	Safety helmet	yellow	123	9772239	uvex pheos B-S-WR	Safety helmet with reflective sticker	orange	128
9762220	uvex airwing B	Safety helmet	orange	122	9772240	uvex pheos IES	Safety helmet	orange	128
9762221	uvex airwing B-S	Safety helmet	orange	123	9772260	uvex pheos S-KR Mips	Safety helmet	hi-viz orange	117
9762230	uvex airwing B-WR	Safety helmet	orange	122	9772271	uvex pheos ABS B-S-WR	Safety helmet	orange	125
9762231	uvex airwing B-S-WR	Safety helmet	orange	123	9772320	uvex pheos B	Safety helmet	red	126
9762320	uvex airwing B	Safety helmet	red	122	9772326	uvex pheos B	Safety helmet with reflective sticker	red	128
9762321	uvex airwing B-S	Safety helmet	red	123	9772330	uvex pheos B-WR	Safety helmet	red	126
9762330	uvex airwing B-WR	Safety helmet	red	122	9772332	uvex pheos B-S-WR	Safety helmet	red	126
9762331	uvex airwing B-S-WR	Safety helmet	red	123	9772334	uvex pheos B-S-WR	Safety helmet with reflective sticker	red	128
9762420	uvex airwing B	Safety helmet	green	122	9772335	uvex pheos S-KR	Safety helmet	red	128
9762421	uvex airwing B-S	Safety helmet	green	123	9772340	uvex pheos IES	Safety helmet	red	128
9762430	uvex airwing B-WR	Safety helmet	green	122	9772371	uvex pheos ABS B-S-WR	Safety helmet	red	125
9762431	uvex airwing B-S-WR	Safety helmet	green	123	9772430	uvex pheos B-WR	Safety helmet	green	126
9762520	uvex airwing B	Safety helmet	blue	122	9772437	uvex pheos B-WR	Safety helmet with reflective sticker	green	128
9762521	uvex airwing B-S	Safety helmet	blue	123	9772520	uvex pheos B	Safety helmet	blue	126
9762530	uvex airwing B-WR	Safety helmet	blue	122	9772526	uvex pheos B	Safety helmet with reflective sticker	red	128
9762531	uvex airwing B-S-WR	Safety helmet	blue	123	9772530	uvex pheos B-WR	Safety helmet	blue	126
9762920	uvex airwing B	Safety helmet	black	122	9772531	uvex pheos B-S-WR	Safety helmet	blue	126
9770020	uvex pheos E	Safety helmet	white	127	9772534	uvex pheos S-KR	Safety helmet	blue	128
9770026	uvex pheos E	Safety helmet with reflective sticker	white	128	9772537	uvex pheos B-S-WR	Safety helmet with reflective sticker	blue	126
9770030	uvex pheos E-WR	Safety helmet	white	127	9772538	uvex pheos B-WR	Safety helmet with reflective sticker	blue	126
9770031	uvex pheos E-S-WR	Safety helmet	white	127	9772540	uvex pheos IES	Safety helmet	blue	128
9770036	uvex pheos E-WR	Safety helmet with reflective sticker	white	128	9772832	uvex pheos B-S-WR	Safety helmet	dark grey	126
9770120	uvex pheos E	Safety helmet	yellow	127	9772920	uvex pheos B	Safety helmet	black	126
9770126	uvex pheos E	Safety helmet with reflective sticker	yellow	128	9772926	uvex pheos B	Safety helmet with reflective sticker	black	128



Safety Helmets

Overview

Art. no.	Name	Description	Colour	Page	Art. no.	Name	Description	Colour	Page
9772930	uvex pheos B-WR	Safety helmet	black	126	9794400	uvex u-cap sport	Impact cap, size 52 – 54 cm	black	147
9772932	uvex pheos B-S-WR	Safety helmet	black	126	9794401	uvex u-cap sport	Impact cap, size 55 – 59 cm	black	147
9772936	uvex pheos B-WR	Safety helmet with reflective sticker	black	128	9794402	uvex u-cap sport	Impact cap, size 60 – 63 cm	black	147
9773050	uvex pheos alpine	Safety helmet	white	124	9794403	uvex u-cap sport	Impact cap, size 55 – 59 cm	black	147
9773150	uvex pheos alpine	Safety helmet	yellow	124	9794404	uvex u-cap sport	Impact cap, size 60 – 63 cm	black	147
9773250	uvex pheos alpine	Safety helmet	orange	124	9794407	uvex u-cap sport	Impact cap, size 55 – 59 cm	navy blue	148
9773350	uvex pheos alpine	Safety helmet	red	124	9794408	uvex u-cap sport	Impact cap, size 60 – 63 cm	navy blue	148
9773450	uvex pheos alpine	Safety helmet	green	124	9794409	uvex u-cap sport	Impact cap, size 52 – 54 cm	black	147
9773550	uvex pheos alpine	Safety helmet	blue	124	9794415	uvex u-cap sport	Suspension harness	black	147
9773950	uvex pheos alpine	Safety helmet	black	124	9794416	uvex u-cap sport vent	Impact cap, size 55 – 59 cm	black	148
9774236	uvex pheos	Forestry	yellow	125	9794417	uvex u-cap sport vent	Impact cap, size 60 – 63 cm	black	148
9774237	uvex pheos	Forestry	orange	125	9794420	uvex u-cap sport vent	Impact cap, size 55 – 59 cm	black	148
9774238	uvex pheos	Forestry	red	125	9794421	uvex u-cap sport vent	Impact cap, size 60 – 63 cm	black	148
9790000	Accessories	Suspension harness thermo boss, super boss		130	9794422	uvex u-cap sport	Impact cap, size 55 – 59 cm	black	147
9790004	Accessories	Sweatband artificial leather for thermo boss, super boss		130	9794423	uvex u-cap sport	Impact cap, size 55 – 59 cm	black	147
9790005	Accessories	Leather chin straps		131	9794424	uvex u-cap sport	Impact cap, size 60 – 63 cm	black	147
9790006	Accessories	Hygienic cap	white	129	9794425	uvex u-cap sport	Impact cap, size 60 – 63 cm	black	147
9790007	Accessories	Forked chin straps		131	9794430	uvex u-cap sport vent	Impact cap, size 52 – 54 cm	black	148
9790010	Accessories	Winter cap	black	129	9794442	uvex u-cap sport	Impact cap, size 52 – 54 cm	black	147
9790012	Accessories	Winter cap	black	129	9794443	uvex u-cap sport	Impact cap, size 52 – 54 cm	black	147
9790015	Accessories	Winter cap	black	129	9794444	uvex u-cap sport vent	Impact cap, size 52 – 54 cm	black	148
9790016	Accessories	Winter cap	black	129	9794480	uvex u-cap sport hi-viz	Impact cap, size 55 – 59 cm	hi-viz yellow	148
9790018	uvex pheos reflex set M	Reflective set		130	9794481	uvex u-cap sport hi-viz	Impact cap, size 60 – 63 cm	hi-viz yellow	148
9790021	Accessories	Four-point chin strap		131	9794482	uvex u-cap sport hi-viz	Impact cap, size 52 – 54 cm	hi-viz yellow	148
9790022	Accessories	Goggles clip/chin strap clip		131	9794490	uvex u-cap sport hi-viz	Impact cap, size 55 – 59 cm	hi-viz orange	148
9790023	Accessories	Pen holder		131	9794491	uvex u-cap sport hi-viz	Impact cap, size 60 – 63 cm	hi-viz orange	148
9790028	Accessories	LED head torch KS-7630-MCII		132	9794492	uvex u-cap sport hi-viz	Impact cap, size 52 – 54 cm	hi-viz orange	148
9790029	Accessories	LED head torch KS-6002-DUO		132	9906002	Accessories	uvex pheos Visor	clear	137
9790035	Accessories	Leather chin straps		131	9906003	Accessories	uvex pheos magnetic Visor	clear	137
9790047	Accessories	Helmet bracket	black	139	9906005	Accessories	uvex pheos SLB 1 Visor	clear	137
9790048	Accessories	Visor lens, PC	clear	139	9906006	Accessories	uvex pheos SLB 1 magnetic Visor	clear	137
9790062	Accessories	LED head torch pheos Lights		132	9906007	Accessories	uvex pheos SLB 2 Visor	blue	137
9790063	Accessories	LED head torch pheos Lights EX		132	9906008	Accessories	uvex pheos SLB 2 magnetic Visor	blue	137
9790064	Accessories	LED head torch u-cap sport		132	9906009	Accessories	uvex pheos magnetic with chin guard	black	137
9790065	Accessories	Winter cap	hi-viz yellow	129	9906012	Accessories	Replacement lens pheos Visor	clear	137
9790066	Accessories	Balaclava	black	129	9906013	Accessories	Replacement lens pheos SLB 1 Visor	clear	137
9790067	Accessories	Visor adapter	black	138	9906014	Accessories	Replacement lens pheos Visor with chin guard	clear	137
9790068	Accessories	Winter cap	hi-viz orange	129	9906017	Accessories	Replacement lens pheos SLB 2 Visor	blue	137
9790069	Accessories	Helmet adapter for LED head torch u-cap sport		132	9924010	Accessories	Adapter	black	139
9790071	Accessories	Helmet bag		131	9954362	Accessories	Cloth bag for uvex visors	black	138
9790074	Accessories	Sunglare filter/rain cover		138					
9790075	Accessories	Neck protection	orange	129					
9790076	Accessories	Neck protection	yellow	129					
9790077	Accessories	Helmet slot sealing plug set		131					
9790078	Accessories	Helmet adapter		138					
9790086	Accessories	cooling neck protection		129					
9790146	Accessories	Signal whistle		125					
9790149	Accessories	Neck support		131					
9790150	Accessories	uvex pheos helmet sticker	silver	131					
9790151	Accessories	uvex pheos helmet sticker	yellow	131					
9790152	Accessories	uvex pheos helmet sticker	orange	131					
9790153	Accessories	uvex pheos helmet sticker	red	131					
9790154	Accessories	uvex pheos helmet sticker	green	131					
9790155	Accessories	uvex pheos helmet sticker	blue	131					
9790156	Accessories	uvex pheos helmet sticker	black	131					
9790159	Accessories	uvex pheos faceguard bump cap	black	141					
9790160	Accessories	Replacement lens mesh visor		141					
9790166	Accessories	Business card holder		131					
9790170	Accessories	Sun/Neck protection		141					
9790210	Accessories	Replacement visor (metal)		125					
9790211	uvex pheos faceguard	uvex pheos faceguard face protection system		141					
9790212	uvex pheos faceguard	uvex pheos faceguard face protection system with hearing protection		141					
9790213	Accessories	V3air rechargeable		132					
9790214	Accessories	Universal silicone strap		132					
9790215	uvex pheos faceguard	uvex pheos faceguard mesh visor with hearing protection		141					
9794110	Baseball cap	with long brim, size 55 – 63 cm	black	147					
9794111	Baseball cap	with short brim, size 55 – 63 cm	black	147					



Breathing Protection

EN149:2001+A1:2009

Respiratory protective devices – filtering half-masks for protection against particles

All uvex respirators are tested and approved in accordance with the **European standard 149**. This standard sets out a wide range of requirements for respirators, with the aim of providing the user with the highest level of protection and comfort.

The key tests defined in EN149 are:

- measuring inhalation and exhalation resistance
- testing the exhalation valve
- visual inspection (marking, instructions for use)
- determining the filtering efficiency (protection class)
- optional: carrying out the dolomite dust test

Detailed information about the standards and guidelines for respiratory protection is available at:

<https://ures.uvex.de>



The standard divides respirators into three protection classes according to their filtering efficiency and leakage:

FFP 1

FFP1 respirators have a filtering capacity of at least 80% and filter up to four times the respective occupational exposure limit (OEL*). These masks are suitable for particles that are neither toxic nor fibrogenic.

FFP 2

FFP2 respirators are suitable for smoke, particles and dusts that are noxious or harmful to health. They filter at least 94% of particles and can be used up to ten times the respective occupational exposure limit (OEL*).

FFP 3

With a filtering efficiency of at least 99%, FFP3 masks constitute the highest protection class. They filter up to 30 times the respective occupational exposure limit (OEL*) and are suitable for protecting against toxic particles, dusts and smoke.



So that you can see the protection class at a glance, the marking is **blue** on FFP1 masks, **orange** on FFP2 masks and **black** on FFP3 masks.



In addition to the standard tests, all uvex masks fulfil the additional requirement of the dolomite dust test and are therefore marked with the letter D. Therefore the uvex respiratory protection products ensure an excellent breathability, even in extremely dusty environments and during prolonged use.

All uvex respirators are in line with current EU legislation. All respiratory protective devices fall into PPE category III (high risks).

* OELs = The occupational exposure limit values (OELs) are the average concentration of a substance in the air in the workplace, up to which no damage (chronic or acute) is to be expected if employees work there for eight hours a day for five days a week. The OELs replace the maximum workplace concentration (MWC) and the technical reference concentration (TRC) – however, as long as both of these values are not yet fully taken into account in the OELs, they can still be used on an interim basis for assessing risks in the workplace.

The uvex breathing protection navigator

The fast route to finding the right respirator for your needs

Choosing the right respiratory protective devices is essential for ensuring the safety of the respective wearer and is a process that requires the utmost care. In order to choose the filtering respirator that meets your requirements, please observe the following points:



- the type, composition and concentration of the hazardous substances must be provided/known (note the CAS number and OEL). The measurement can be carried out by the employers' liability insurance association, for example. The minimum requirements for selected areas of application can be found on the next page.
- after determining the protection class required (FFP1, FFP2 or FFP3), the following table can be used to select a respirator model that meets the requirements of the respective work conditions.
- there must be a sufficient volume of oxygen in the environment. Please observe the statutory regulations in this regard. A minimum of 17 vol% is required in Germany.
- if further PPE is required, this must be compatible. uvex respirators are ideal for use in combination with uvex safety spectacles – see the compatibility table on page 155.
- respiratory protective devices are not suitable for people with beards, sideburns or deep scars near the respirator sealing lines as these prevent a secure fit. Please contact your safety officer for a custom solution.
- Masks marked "NR" should not be used for more than eight hours. Masks marked "R" may be used for up to 24 hours but must be cleaned after each period of use. Masks should be replaced without delay if the breathing resistance becomes noticeably higher.
- if a half-mask with gas filters is required for the work-space, please note that the uvex respirator models do not offer adequate protection.



Selection

Brief periods of use or lighter activities at normal ambient temperatures		
Protection class	Folding mask (with or without valve)	Cup-style mask (without or without valve)
FFP1	3100, 3110, 8103, 8113, 5100, 5100+, 5110, 5110+	2100, 2110, 7100, 7110
FFP2	3200, 3210, 8203, 8213, 5200, 5200+, 5210, 5210+	2200, 2210, 7200, 7210, 7212
FFP3	3310, 8313, 5310, 5310+	2310, 2312, 7310
Long periods of wear or hard, strenuous activities at increased ambient temperatures		
Protection class	Folding mask (with valve)	Cup-style mask (with valve)
FFP1	3110, 8113, 5110, 5110+	2110, 7110
FFP2	3210, 8213, 5210, 5210+	2210, 7210, 7212, 7233, 7232
FFP3	3310, 8313, 5310, 5310+	2310, 2312, 7310, 7333, 7330, 7312, 7317
With activated carbon layer to protect against unpleasant odours		
Protection class	Folding mask (with valve)	Cup-style mask (with valve)
FFP1	-	-
FFP2	3220, 5220+	2220, 7220
FFP3	5320+	7320, 2320, 2322

► The minimum requirements for selected areas of application can be found on page 154.

uvex silv-Air
Areas of application



Activity	Harmful substances	Protection class		
		FFP1	FFP2	FFP3
Wood processing				
Softwood: cutting and sanding	Fine particles, wood dust		■	
Hard wood (oak, beech, tropical woods, etc.): cutting and sanding	Fine particles, wood dust			■
Brushing/sanding paint	Fine colour particles		■	
Brushing/sanding paint (paints containing chrome)	Fine colour particles			■
Soluble paints containing copper/chrome/arsenic	Fine paint mist			■
Construction and ancillary building industry				
Cement work, plastering, tiling, roofing	Cement, plaster, tile or brick dust		■	
Masonry: cutting, drilling, demolition			■	
Asbestos: short periods of work	Fibres			■
Roof insulation: glass and mineral fibres	Dust and fibres		■	
Bodyfillers/stopper: Grinding	Dust		■	
Welding				
Welding aluminium and stainless steel	Metal and aluminium oxide fumes			■
Brazing	Fumes			■
Metalwork				
Metal: drilling, grinding, milling, angle grinding	Metal dust		■	
High-alloy steels and stainless steels: drilling, grinding, milling, angle grinding	Metal dust			■
Waste disposal and cleaning				
Refuse separation and disposal	Dust, fungi		■	
Medical waste disposal	Bacteria, spores			■
Sweeping floors	Dust (non-toxic)	■		
Radioactively contaminated particles	Dust			■
Agriculture				
Animal epidemics and treatment of animals with diseases	Bacteria, viruses			■
Work with fungal spores	Spores			■
Work with hay, grain and flour	Dust	■		
Medicine/care/health				
Allergies, pollen, household dust, animal fur	Dust, particles, spores		■	
Bacteria, viruses, infections, legionella bacteria	Bacteria, viruses			■

► These filter classes are minimum requirements and simply serve as a guide. It is the wearers' responsibility to make sure the breathing apparatus conforms to the requirements in terms of hazardous materials and concentration before use!

Perfect Match

Combination options of uvex silv-Air respirators with uvex safety eyewear

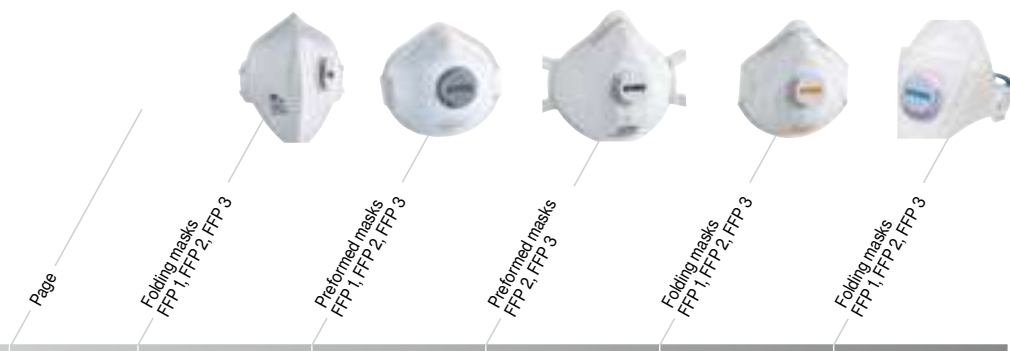

	Page	Folding masks FFP 1, FFP 2, FFP 3	Preformed masks FFP 1, FFP 2, FFP 3	Preformed masks FFP 2, FFP 3	Folding masks FFP 1, FFP 2, FFP 3	Folding masks FFP 1, FFP 2, FFP 3
uvex silv-Air premium	156 - 158					5100, 5100+, 5110, 5110+, 5200, 5200+, 5210, 5210+, 5220+, 5310, 5310+, 5320+
uvex silv-Air e	159 - 161		7212, 7233, 7312, 7317, 7333	7232, 7330		
uvex silv-Air c	162 - 165	3100, 3110, 3200, 3210, 3220, 3310		2310, 2312, 2320, 2322	2100, 2110, 2200, 2210, 2220	
uvex i-3 uvex i-5	46 - 47 36 - 37	■	□	□	□	■
uvex pheos uvex sportstyle	44 - 45 41	■	■	□	■	■
uvex super fit uvex super g	51 50	■	■	□	□	■
uvex x-fit uvex x-fit pro	39 38	■	■	■	■	■
uvex i-vo	52	■	■	□	■	■
uvex i-works	48	■	□	□	□	■
uvex pheos cx2	42	■	□	□	□	■
uvex pheos cx2 sonic	60	■	■	■	■	■
uvex super OTG uvex super f OTG	56 57	■	■	■	■	■
uvex astrospec 2.0 uvex skyguard NT	49 53	■	□	□	■	■
uvex carbonvision	67	■	■	□	□	■
uvex ultrasonic uvex ultravision	63 64 - 65	■	■	■	■	■
uvex megasonic	59	■	□	□	■	■



These recommendations are based on experience. We recommend always carrying out wearability tests.

■ Perfect combination

□ Suitable to a limited extent

uvex silv-Air premium Respirators



- contour-optimised design for maximum wearer comfort and a secure fit
- available in two sizes for improved fit
- sealing lip (in the nose area for FFP1 and FFP2, in the nose and chin area for FFP3) and nose clip provide greater comfort and a very secure fit
- the masks are packaged individually to meet the highest hygiene requirements
- adjustable textile headband for greater protection and comfort
- optional: exhalation valve for reducing heat and humidity
- models in FFP2 and FFP3 against unpleasant odours available (5220+, 5320+)



The nose clip is easy to adjust, ensuring a particularly good fit.



The comfortable sealing lip offers maximum comfort and a reliable fit.



The masks are packaged individually and therefore meet the highest hygiene requirements.



The extra-wide textile headband ensures that the mask fits comfortably and securely.



Exhalation valve for reducing heat and humidity.

uvex silv-Air premium

FFP 1		FFP 2		FFP 3	
flat fold		flat fold		flat fold	
Small version	Large version	Small version	Large version	Small version	Large version
 5100 NR D	 5100+ NR D	 5200 NR D	 5200+ NR D	 5310 NR D	 5310+ NR D
 5110 NR D	 5110+ NR D	 5210 NR D	 5210+ NR D		
			 5220+ NR D with carbon		 5320+ NR D with carbon

uvex silv-Air premium Respirators, class FFP1 and FFP2



uvex silv-Air 5100 // 5110

- particle-filtering flat-fold mask for **small to medium face shapes**
- wide, seamless headband for ensuring a comfortable and secure fit
- incorporated nose clip that is easy to adjust
- comfortable sealing lip in the nose area for a reliable fit
- 5110: exhalation valve for reducing heat and humidity as well as noticeably reducing breathing resistance

	uvex silv-Air 5100		uvex silv-Air 5110	
Art. no.	8735100	8745100	8735110	8745110
Version	FFP1 NR D folding mask without valve – small version white		FFP1 NR D folding mask with valve – small version white	
Colour	white		white	
Order quantity multiple/ Order unit	BOX	BG	BOX	BG
Content	30 PC, individually packed in BOX	3 PC, individually packed in BG	15 PC, individually packed in BOX	3 PC, individually packed in BG

uvex silv-Air 5100+ // 5110+

- particle-filtering flat-fold mask for **larger face shapes**
- wide, seamless headband for ensuring a comfortable and secure fit
- comfortable sealing lip in the nose area for a reliable fit
- incorporated nose clip that is easy to adjust
- 5110+: exhalation valve for reducing heat and humidity as well as noticeably reducing breathing resistance

	uvex silv-Air 5100+		uvex silv-Air 5110+	
Art. no.	8735101	8745101	8735111	8745111
Version	FFP1 NR D folding mask without valve – large version white		FFP1 NR D folding mask with valve – large version white	
Colour	white		white	
Order quantity multiple/ Order unit	BOX	BG	BOX	BG
Content	30 PC, individually packed in BOX	3 PC, individually packed in BG	15 PC, individually packed in BOX	3 PC, individually packed in BG



uvex silv-Air 5200 // 5210

- particle-filtering flat-fold mask for **small to medium face shapes**
- wide, seamless headband for ensuring a comfortable and secure fit
- incorporated nose clip that is easy to adjust
- comfortable sealing lip in the nose area for a reliable fit
- 5210: exhalation valve for reducing heat and humidity as well as noticeably reducing breathing resistance

	uvex silv-Air 5200		uvex silv-Air 5210	
Art. no.	8735200	8745200	8735210	8745210
Version	FFP2 NR D folding mask without valve – small version white		FFP2 NR D folding mask with valve – small version white	
Colour	white		white	
Order quantity multiple/ Order unit	BOX	BG	BOX	BG
Content	30 PC, individually packed in BOX	3 PC, individually packed in BG	15 PC, individually packed in BOX	3 PC, individually packed in BG

uvex silv-Air 5200+ // 5210+ // 5220+

- particle-filtering flat-fold mask for **larger face shapes**
- wide, seamless headband for ensuring a comfortable and secure fit
- incorporated nose clip that is easy to adjust
- comfortable sealing lip in the nose area for a reliable fit
- 5210+/ 5220+: exhalation valve for reducing heat and humidity as well as noticeably reducing breathing resistance
- 5220+: additional activated carbon filter for protection against odours, gases and vapours under the respective limit values

	uvex silv-Air 5200+		uvex silv-Air 5210+	
Art. no.	8735201	8745201	8735211	8745211
Version	FFP2 NR D folding mask without valve – large version white		FFP2 NR D folding mask with valve – large version white	
Colour	white		white	
Order quantity multiple/ Order unit	BOX	BG	BOX	BG
Content	30 PC, individually packed in BOX	3 PC, individually packed in BG	15 PC, individually packed in BOX	3 PC, individually packed in BG

	uvex silv-Air 5220+	
Art. no.	8735221	8745221
Version	FFP2 NR D folding mask with valve and carbon – large version	
Colour	grey	
Order quantity multiple/ Order unit	BOX	BG
Content	15 PC, individually packed in BOX	3 PC, individually packed in BG

uvex silv-Air premium Respirators in protection class FFP3



8735310
8745310

uvex silv-Air 5310

- particle-filtering flat-fold mask for **small to medium face shapes**
- wide, seamless headband for ensuring a comfortable and secure fit
- comfortable sealing lip in the nose and chin area for a reliable fit
- incorporated nose clip that is easy to adjust
- exhalation valve for reducing heat and humidity as well as noticeably reducing breathing resistance

uvex silv-Air 5310		
Art. no.	8735310	8745310
Version	FFP3 NR D folding mask with valve – small version	
Colour	white	
Order quantity multiple/	BOX	BG
Order unit		
Content	15 PC, individually packed in BOX	3 PC, individually packed in BG



8735311
8745311

uvex silv-Air 5310+

- particle-filtering flat-fold mask for **larger face shapes**
- wide, seamless headband for ensuring a comfortable and secure fit
- comfortable sealing lip in the nose and chin area for a reliable fit
- incorporated nose clip that is easy to adjust
- exhalation valve for reducing heat and humidity as well as noticeably reducing breathing resistance

uvex silv-Air 5310+		
Art. no.	8735311	8745311
Version	FFP3 NR D folding mask with valve – large version	
Colour	white	
Order quantity multiple/	BOX	BG
Order unit		
Content	15 PC, individually packed in BOX	3 PC, individually packed in BG



8735321
8745321

uvex silv-Air 5320+

- particle-filtering flat-fold mask for **larger face shapes**
- wide, seamless headband for ensuring a comfortable and secure fit
- comfortable sealing lip in the nose and chin area for a reliable fit
- incorporated nose clip that is easy to adjust
- exhalation valve for reducing heat and humidity as well as noticeably reducing breathing resistance
- additional activated carbon filter for protection against odours, gases and vapours under the respective limit values

uvex silv-Air 5320+		
Art. no.	8735321	8745321
Version	FFP3 NR D folding mask with valve and carbon – large version	
Colour	grey	
Order quantity multiple/	BOX	BG
Order unit		
Content	15 PC, individually packed in BOX	3 PC, individually packed in BG

uvex silv-Air e
Respirators

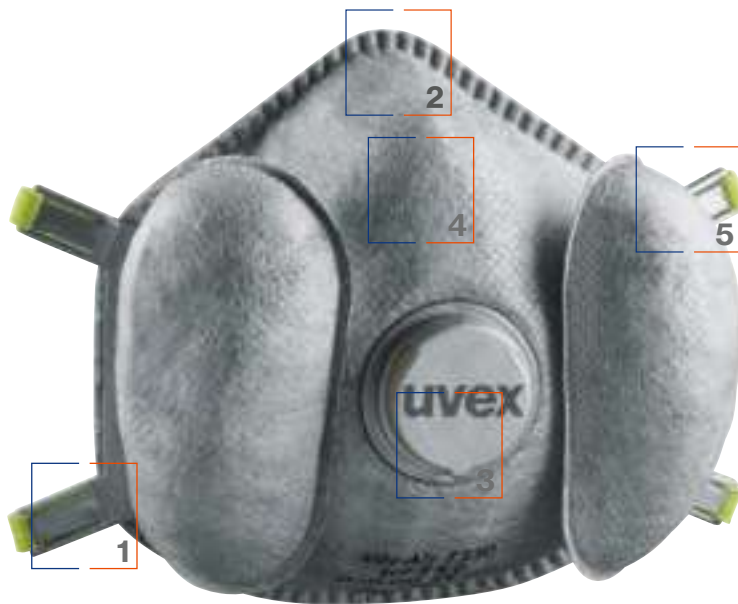

- high-performance respirator – excellent protection with maximum wearer comfort
- the combination of a high-quality filter material and a larger filter surface noticeably reduces the breathing resistance
- the additional inhalation valves ensure a cool climate inside the mask (cooling effect)
- 3D nose geometry for a perfectly secure fit
- adjustable textile headband for a customised and comfortable fit
- the integrated sealing lip provides extremely high comfort



Adjustable headband for optimum fit



Perfectly shaped around the nose for secure positioning



Large inhalation valves ensure extremely low breathing resistance.



Nasal recess ensures a perfect fit for almost any nose shape.



Flexible 4-point headband attachment for a comfortable fit.

uvex silv-Air e

FFP 1		FFP 2		FFP 3		
		cup style		flatfold	cup style	
		7212 NR D		8313 NR D	7312 R D	7317 R D
		7232 R D	7233 R D		7333 R D	7330 R D

uvex silv-Air e

High-performance respirators in protection class FFP2 and FFP3



How-to-use video



8787233
8787333

8787232
8787330

8788313

uvex silv-Air High-Performance – A new dimension in breathing protection

- particle-filtering preformed mask with exhalation valve and inhalation valves
- High-performance climazone system with three compartments for a comfortable, cool climate inside the mask
- flexible textile headband with neck clip for individual adjustment
- exhalation valve for reducing heat and humidity as well as noticeably reducing breathing resistance
- two extra filters with inhalation valves for lower breathing resistance and increased comfort due to easier air exchange
- very soft, all-around sealing lip for optimal wearer comfort and secure fit
- combination of 3D nose area and sealing lip ensures ideal fit for almost any nose shape

uvex silv-Air High-Performance – Perfect protection combined with maximum wearer comfort

- particle-filtering preformed mask with exhalation valve and inhalation valves
- High-performance climazone system with three compartments for a comfortable, cool climate inside the mask
- four-point headband attachment for a comfortable, individual and secure fit
- flexible, adjustable integrated nose clip
- exhalation valve for reducing heat and humidity as well as noticeably reducing breathing resistance
- two extra filters with inhalation valves for lower breathing resistance and increased comfort due to easier air exchange
- very soft, all-around sealing lip for optimal wearer comfort and secure fit
- nasal recess on the sealing lip ensures ideal fit for almost any nose shape

uvex silv-Air 8313

- particle-filtering flat-fold mask with exhalation valve
- hydrophobic material coating
- four-point headband attachment for a comfortable, individual and secure fit
- flexible, adjustable integrated nose clip
- very soft, all-around sealing lip for optimal wearer comfort and secure fit
- exhalation valve for reducing heat and humidity as well as noticeably reducing breathing resistance

	uvex silv-Air 7233	uvex silv-Air 7333
Art. no.	8787233	8787333
Version	FFP2 R D	FFP3 R D
	preformed mask with valves	preformed mask with valves
Colour	white	white
Order quantity multiples	BOX	BOX
Content	3 PC, packed in BOX	3 PC, packed in BOX

	uvex silv-Air 7232	uvex silv-Air 7330
Art. no.	8787232	8787330
Version	FFP2 R D	FFP3 R D
	preformed mask with valves	preformed mask with valves
Colour	silver grey	silver grey
Order quantity multiples	BOX	BOX
Content	3 PC, packed in BOX	3 PC, packed in BOX

uvex silv-Air 8313	
Art. no.	8788313
Version	folding mask FFP3 NR D with valve
Colour	white
Order quantity multiples	BOX
Content	15 PC, individually packed in BOX

uvex silv-Air e

High-performance respirators in protection class FFP2 and FFP3



8787317
8787318

8787312

8787212

uvex silv-Air 7317

- particle-filtering preformed mask with exhalation valve
- soft material edges for increased comfort
- very soft, all-around sealing lip for optimal wearer comfort and secure fit
- without nose clip (metal-free)
- four-point headband attachment for a comfortable, individual and secure fit
- exhalation valve for reducing heat and humidity as well as noticeably reducing breathing resistance
- extra-wide textile headband ensures that the mask fits comfortably and securely

uvex silv-Air 7312

- particle-filtering preformed mask with exhalation valve
- soft material edges for increased comfort
- very soft, all-around sealing lip for optimal wearer comfort and secure fit
- flexible, adjustable integrated nose clip
- four-point headband attachment for a comfortable, individual and secure fit
- exhalation valve for reducing heat and humidity as well as noticeably reducing breathing resistance

uvex silv-Air 7212

- particle-filtering preformed mask with exhalation valve
- soft material edges for increased comfort
- seamless headband for a comfortable, secure fit
- very soft, all-around sealing lip for optimal wearer comfort and secure fit
- flexible, adjustable integrated nose clip
- exhalation valve for reducing heat and humidity as well as noticeably reducing breathing resistance

uvex silv-Air 7317	
Art. no.	8787317 8787318
Version	FFP3 R D preformed mask with valve
Colour	white
Order unit	BOX CT
Content	5 PC, 80 PC, individually packed in BOX packed in CT

uvex silv-Air 7312	
Art. no.	8787312
Version	FFP3 R D preformed mask with valve
Colour	white
Order quantity multiples	BOX
Content	5 PC, packed in BOX

uvex silv-Air 7212	
Art. no.	8787212
Version	FFP2 NR D preformed mask with valve
Colour	white
Order quantity multiples	BOX
Content	15 PC, packed in BOX



Anatomically preformed nose area and integrated nosepiece within the filter material, ensures a perfect fit and the highest level of wearer comfort.



4-point headband attachment for a comfortable, secure fit of the mask.



The high-quality filter material ensures low breathing resistance, while the smooth white filter surface reduces the risk of contamination through "linting" in areas with strict hygiene standards.

uvex silv-Air c

Respirators in protection class FFP1, FFP2 and FFP3



- soft material edges for greater comfort and wearer acceptance
- continuous textile headband ensures that the mask fits comfortably and securely
- optional: exhalation valve to reduce heat and humidity in the mask
- sealing lip (in the nose area for FFP1 and FFP2, all-round for FFP3) and nose clip provide maximum protection and comfort
- FFP2 and FFP3 models against unpleasant odours available (2220, 3220, 2320, 2322)
- FFP3 preformed masks are available in two sizes and also have a four-point headband attachment



1 The adjustable nose clip ensures an excellent individual fit and secure positioning.



2 The soft material edges prevent uncomfortable pressure points.



3 The seamless headband can be adjusted for an optimum fit.



4 The exhalation valve with a 360° opening ensures very low breathing resistance and a cooling effect climate inside the mask.



5 The upper face seal offers both a more secure positioning of the mask and increased wearer comfort.

uvex silv-Air c

	FFP 1		FFP 2			FFP 3			
flatfold	 3100 NR D	 3110 NR D	 3200 NR D	 3210 NR D	 3220 NR D with carbon	 3310 NR D			
cup style	 2100 NR D	 2110 NR D	 2200 NR D	 2210 NR D	 2220 NR D with carbon	 2310 NR D	 2312 NR D	 2320 NR D with carbon	 2322 NR D with carbon

uvex silv-Air c

Filtering face masks, protection class FFP1



8763100
8743100



8763110
8743110

uvex silv-Air 3100 // 3110

- particle-filtering folding mask
- seamless headband and flexible, adjustable nose clip
- comfortable sealing lip in nose area for secure fit

- 3110: exhalation valve for reducing heat and humidity as well as noticeably reducing breathing resistance



uvex silv-Air 3100		
Art. no.	8763100	8743100
Version	FFP1 NR D folding mask without valve	
Colour	white	
Order quantity multiple/	BOX	BG
Order unit		
Content	30 PC, individually packed in BOX	3 PC, individually packed in BG

uvex silv-Air 3110		
Art. no.	8763110	8743110
Version	FFP1 NR D folding mask with valve	
Colour	white	
Order quantity multiple/	BOX	BG
Order unit		
Content	15 PC, individually packed in BOX	3 PC, individually packed in BG



8762100
8742101



8762110
8742111

uvex silv-Air 2100 // 2110

- particle-filtering preformed mask
- seamless headband and nose clip for a comfortable, secure fit
- comfortable sealing lip in nose area for secure fit

- 2110: exhalation valve for reducing heat and humidity as well as noticeably reducing breathing resistance

uvex silv-Air 2100		
Art. no.	8762100	8742101
Version	FFP1 NR D preformed mask without valve	
Colour	white	
Order quantity multiple/	BOX	BG
Order unit		
Content	20 PC, packed in BOX	3 PC, packed in BG

uvex silv-Air 2110		
Art. no.	8762110	8742111
Version	FFP1 NR D preformed mask with valve	
Colour	white	
Order quantity multiple/	BOX	BG
Order unit		
Content	15 PC, packed in BOX	3 PC, packed in BG

uvex silv-Air c

Filtering face masks, protection class FFP2



8763200
8743200

8763210
8743210

How-to-use video



8763220

uvex silv-Air 3200 // 3210

- particle-filtering folding mask
- seamless headband and flexible, adjustable nose clip
- comfortable sealing lip in nose area for secure fit
- 3210: exhalation valve for reducing heat and humidity as well as noticeably reducing breathing resistance

uvex silv-Air 3200		
Art. no.	8763200	8743200
Version	FFP2 NR D folding mask without valve	
Colour	white	
Order quantity multiple/ Order unit	BOX	BG
Content	30 PC, individually packed in BOX 3 PC, individually packed in BG	

uvex silv-Air 3210		
Art. no.	8763210	8743210
Version	FFP2 NR D folding mask with valve	
Colour	white	
Order quantity multiple/ Order unit	BOX	BG
Content	15 PC, individually packed in BOX 3 PC, individually packed in BG	

uvex silv-Air 3220

- particle-filtering folding mask with exhalation valve
- additional activated carbon filter against odours, gases and vapours below threshold
- seamless headband and flexible, adjustable nose clip
- comfortable sealing lip in nose area for secure fit
- exhalation valve for reducing heat and humidity as well as noticeably reducing breathing resistance

uvex silv-Air 3220		
Art. no.	8763220	
Version	FFP2 NR D folding mask with valve and carbon	
Colour	silver	
Order quantity multiple/ Order unit	BOX	
Content	15 PC, individually packed in BOX	



8762200
8742201

8762210
8742211

How-to-use video



8762220

uvex silv-Air 2200 // 2210

- particle-filtering preformed mask
- seamless headband and flexible, adjustable nose clip for a comfortable, secure fit
- comfortable sealing lip in nose area for secure fit
- 2210: exhalation valve for reducing heat and humidity as well as noticeably reducing breathing resistance

uvex silv-Air 2200		
Art. no.	8762200	8742201
Version	FFP2 NR D preformed mask without valve	
Colour	white	
Order quantity multiple/ Order unit	BOX	BG
Content	20 PC, packed in BOX 3 PC, packed in BG	

uvex silv-Air 2210		
Art. no.	8762210	8742211
Version	FFP2 NR D preformed mask with valve	
Colour	white	
Order quantity multiple/ Order unit	BOX	BG
Content	15 PC, packed in BOX 3 PC, packed in BG	

uvex silv-Air 2220

- particle-filtering preformed mask with exhalation valve
- additional activated carbon filter against odours, gases and vapours below threshold
- Seamless headband and flexible, adjustable nose clip for a comfortable, secure fit
- comfortable sealing lip in nose area for secure fit
- exhalation valve for reducing heat and humidity as well as noticeably reducing breathing resistance

uvex silv-Air 2220		
Art. no.	8762220	
Version	FFP2 NR D preformed mask with valve and carbon	
Colour	silver	
Order quantity multiple/ Order unit	BOX	
Content	15 PC, packed in BOX	

uvex silv-Air c
Filtering face masks, protection class FFP3



8763310
8743311

uvex silv-Air 3310

- particle-filtering folding mask with exhalation valve
- adjustable headband and flexible, adjustable nose clip for a comfortable, secure fit
- comfortable, all-around sealing lip for secure fit
- exhalation valve for reducing heat and humidity as well as noticeably reducing breathing resistance

uvex silv-Air 3310		
Art. no.	8763310	8743311
Version	FFP3 NR D folding mask with valve	
Colour	white	
Order quantity multiple/ Order unit	BOX	BG
Content	15 PC, individually packed in BOX 3 PC, individually packed in BG	



8762310
8742310

8762312
8742312

How-to-use video



8762320
8742320

8762322
8742322

uvex silv-Air 2310 // 2312

- 2310: particle-filtering preformed mask with exhalation valve for **larger face shapes**
- 2312: particle-filtering preformed mask with exhalation valve – ergonomically adapted for **smaller to medium-sized face shapes**
- four-point headband attachment and flexible, adjustable nose clip for a comfortable, secure fit
- very soft, all-around sealing lip for optimal wearer comfort and secure fit
- exhalation valve for reducing heat and humidity as well as noticeably reducing breathing resistance

uvex silv-Air 2310		
Art. no.	8762310	8742310
Version	FFP3 NR D preformed mask with valve – large version	
Colour	white	
Order quantity multiple/ Order unit	BOX	BG
Content	15 PC, packed in BOX	3 PC, packed in BG

uvex silv-Air 2312		
Art. no.	8762312	8742312
Version	FFP3 NR D preformed mask with valve – small version	
Colour	white	
Order quantity multiple/ Order unit	BOX	BG
Content	15 PC, packed in BOX	3 PC, packed in BG

uvex silv-Air 2320 // 2322

- 2320: particle-filtering preformed mask with exhalation valve for **larger face shapes**
- 2322: particle-filtering preformed mask with exhalation valve – ergonomically adapted for **smaller to medium-sized face shapes**
- four-point headband attachment and flexible, adjustable nose clip for a comfortable, secure fit
- very soft, all-around sealing lip for optimal wearer comfort and secure fit
- exhalation valve for reducing heat and humidity as well as noticeably reducing breathing resistance
- additional activated carbon filter against odours, gases and vapours below threshold values

uvex silv-Air 2320		
Art. no.	8762320	8742320
Version	FFP3 NR D preformed mask with valve and carbon – large version	
Colour	silver	
Order quantity multiple/ Order unit	BOX	BG
Content	15 PC, packed in BOX	3 PC, packed in BG

uvex silv-Air 2322		
Art. no.	8762322	8742322
Version	FFP3 NR D preformed mask with valve and carbon – small version	
Colour	silver	
Order quantity multiple/ Order unit	BOX	BG
Content	15 PC, packed in BOX	3 PC, packed in BG



uvex silv-Air 9517

Filtering face masks, protection class FFP2



8739518
8739519

MADE IN GERMANY 

uvex silv-Air 9517

- particle-filtering flat-fold mask without valve
- comfortable ear bands ensure that the mask fits securely
- flexible, adjustable integrated nose clip
- soft material edges for increased wearer comfort

uvex silv-Air 9517

Art. no.	8739518	8739519
Version	FFP2 NR flat-fold mask with ear bands	
Colour	white	white
Order quantity multiples	BOX	CT
Content	10 PC, individually packed in BOX	1000 PC, individually packed in CT

uvex medical face mask type IIR

Medical face mask in accordance with EN 14683:2019 + AC:2019



MADE IN GERMANY 

uvex medical face mask type IIR

- medical face mask type IIR for high bacterial filtering efficiency and protection against liquid splashes
- comfortable ear bands
- adjustable nose wire
- single use for adults
- Made in Germany
- certified medical device

uvex medical face mask type IIR					
Art. no.	8739520	8739521	8739522	8739523	8739524
Version	Medical face mask type IIR				
Colour	white	beige	grey	blue	green
Order quantity multiples	BOX	BOX	BOX	BOX	BOX
Content	50 PC, packed in BOX	50 PC, packed in BOX	50 PC, packed in BOX	50 PC, packed in BOX	50 PC, packed in BOX

The face mask is not PPE, but rather a medical device.

Standard EN 14683:2019 + AC:2019

EN 14683 regulates the requirements for medical face masks. The standard distinguishes between three protection classes: type I, type II and type IIR.

The classification is based on bacterial filtering efficiency, microbiological purity, breathing resistance and resistance to liquid splashes.

Classification	Type I	Type II	Type IIR
Bacterial filtering efficiency (BFE)	≥95%	≥98%	≥98%
Breathing resistance (Pa/cm ²)	<40	<40	<60
Splash resistance pressure (kPa)	not applicable	not applicable	≥16.0
Microbiological purity (CFU/g)	≤30	≤30	≤30

The uvex face mask corresponds to type IIR and therefore offers the highest level of protection.

uvex silv-Air Breathing protection

Quick overview of product features



The **360° exhalation valve** considerably reduces breathing resistance and build-up of heat and moisture in the mask.



The masks are **individually** packed and meet the highest standards of hygiene.



Comfortable all-round sealing lip
The soft sealing lip guarantees a secure, comfortable sealed positioning of the mask.



Carbon inside
The additional activated carbon layer incorporated in the filter material reduces unpleasant odours.



Soft sealing lip in the nose and chin area for a secure and comfortable fit.



The **3D nose area** ensures a comfortable fit, low leakage and prevents misting of uncoated eyewear.



Comfortable sealing lip in the nose area
The soft sealing lip in the nose area guarantees a secure, pressure-free fit.



High performance climate management
The mask offers extremely low breathing resistance due to the filter chambers connected with the inhalation valve. The climate management of the high performance mask guarantees optimum wearer comfort.



Comfort nose clip
The mask is fitted with a high-quality nose clip making it individually adjustable.



R labelling
The mask has been tested for reusability and has the required performance features for wearing during a second work shift.



Metal-free
The mask is completely metal-free and is manufactured entirely of skin-tolerant materials.



“NR” designation
The masks are not reusable and must therefore be disposed of after a work shift.



The **4-point headband attachment** allows an individual and secure fit, which can be perfectly adapted to meet the wearer's requirements.



D labelling
The mask has undergone additional dolomite dust testing and therefore affords excellent breathability, even in extremely dusty environments and during longer periods of use.



uvex clear

• cleaning spray for cleaning respirators marked with “R”

uvex clear cleaning spray	
Art. no.	8701011
Order quantity multiples	1 PC
Content	360 ml

8701011

uvex silv-Air

Overview

Art. no.	Name	Type	Features	Content per PU	PU per carton	Page
8701011	uvex clear	cleaning spray		1 can (360 ml)	100 PC	168
8735100	uvex silv-Air 5100	FFP1 folding mask without valve		30 PC	16 boxes	157
8735101	uvex silv-Air 5100+	FFP1 folding mask without valve		30 PC	16 boxes	157
8735110	uvex silv-Air 5110	FFP1 folding mask with valve		15 PC	16 boxes	157
8735111	uvex silv-Air 5110+	FFP1 folding mask with valve		15 PC	16 boxes	157
8735200	uvex silv-Air 5200	FFP2 folding mask without valve		30 PC	16 boxes	157
8735201	uvex silv-Air 5200+	FFP2 folding mask without valve		30 PC	16 boxes	157
8735210	uvex silv-Air 5210	FFP2 folding mask with valve		15 PC	16 boxes	157
8735211	uvex silv-Air 5210+	FFP2 folding mask with valve		15 PC	16 boxes	157
8735221	uvex silv-Air 5220+ with carbon	FFP2 folding mask with valve		15 PC	16 boxes	157
8735310	uvex silv-Air 5310	FFP3 folding mask with valve		15 PC	16 boxes	158
8735311	uvex silv-Air 5310+	FFP3 folding mask with valve		15 PC	16 boxes	158
8735321	uvex silv-Air 5320+ with carbon	FFP3 folding mask with valve		15 PC	16 boxes	158
8742101	uvex silv-Air 2100, Retail	FFP1 preformed mask without valve		3 PC	20 bags	163
8742111	uvex silv-Air 2110, Retail	FFP1 preformed mask with valve		3 PC	20 bags	163
8742201	uvex silv-Air 2200, Retail	FFP2 preformed mask without valve		3 PC	20 bags	164
8742211	uvex silv-Air 2210, Retail	FFP2 preformed mask with valve		3 PC	20 bags	164
8742310	uvex silv-Air 2310, Retail	FFP3 preformed mask with valve		3 PC	10 bags	165
8742312	uvex silv-Air 2312, Retail	FFP3 preformed mask with valve		3 PC	10 bags	165
8742320	uvex silv-Air 2320 with carbon, Retail	FFP3 preformed mask with valve		3 PC	10 bags	165
8742322	uvex silv-Air 2322 with carbon, Retail	FFP3 preformed mask with valve		3 PC	10 bags	165
8743100	uvex silv-Air 3100, Retail	FFP1 folding mask without valve		3 PC	20 bags	163
8743110	uvex silv-Air 3110, Retail	FFP1 folding mask with valve		3 PC	20 bags	163
8743200	uvex silv-Air 3200, Retail	FFP2 folding mask without valve		3 PC	20 bags	164
8743210	uvex silv-Air 3210, Retail	FFP2 folding mask with valve		3 PC	20 bags	164
8743311	uvex silv-Air 3310, Retail	FFP3 folding mask with valve		3 PC	20 bags	165
8745100	uvex silv-Air 5100, Retail	FFP1 folding mask without valve		3 PC	20 bags	157
8745101	uvex silv-Air 5100+, Retail	FFP1 folding mask without valve		3 PC	20 bags	157
8745110	uvex silv-Air 5110, Retail	FFP1 folding mask with valve		3 PC	20 bags	157
8745111	uvex silv-Air 5110+, Retail	FFP1 folding mask with valve		3 PC	20 bags	157
8745200	uvex silv-Air 5200, Retail	FFP2 folding mask without valve		3 PC	20 bags	157
8745201	uvex silv-Air 5200+, Retail	FFP2 folding mask without valve		3 PC	20 bags	157
8745210	uvex silv-Air 5210, Retail	FFP2 folding mask with valve		3 PC	20 bags	157
8745211	uvex silv-Air 5210+, Retail	FFP2 folding mask with valve		3 PC	20 bags	157
8745221	uvex silv-Air 5220+ with carbon, Retail	FFP2 folding mask with valve		3 PC	20 bags	157
8745310	uvex silv-Air 5310, Retail	FFP3 folding mask with valve		3 PC	20 bags	158
8745311	uvex silv-Air 5310+, Retail	FFP3 folding mask with valve		3 PC	20 bags	158
8745321	uvex silv-Air 5320+ with carbon, Retail	FFP3 folding mask with valve		3 PC	20 bags	158
8762100	uvex silv-Air 2100	FFP1 preformed mask without valve		20 PC	12 boxes	163
8762110	uvex silv-Air 2110	FFP1 preformed mask with valve		15 PC	12 boxes	163
8762200	uvex silv-Air 2200	FFP2 preformed mask without valve		20 PC	12 boxes	164
8762210	uvex silv-Air 2210	FFP2 preformed mask with valve		15 PC	12 boxes	164
8762220	uvex silv-Air 2220 with carbon	FFP2 preformed mask with valve		15 PC	12 boxes	164
8762310	uvex silv-Air 2310	FFP3 preformed mask with valve		15 PC	12 boxes	165
8762312	uvex silv-Air 2312	FFP3 preformed mask with valve		15 PC	12 boxes	165
8762320	uvex silv-Air 2320 with carbon	FFP3 preformed mask with valve		15 PC	12 boxes	165



uvex silv-Air

Overview

Art. no.	Name	Type	Features	Content per PU	PU per carton	Page
8762322	uvex silv-Air 2322 with carbon	FFP3 preformed mask with valve		15 PC	12 boxes	165
8763100	uvex silv-Air 3100	FFP1 folding mask without valve		30 PC	12 boxes	163
8763110	uvex silv-Air 3110	FFP1 folding mask with valve		15 PC	12 boxes	163
8763200	uvex silv-Air 3200	FFP2 folding mask without valve		30 PC	12 boxes	164
8763210	uvex silv-Air 3210	FFP2 folding mask with valve		15 PC	12 boxes	164
8763220	uvex silv-Air 3220 with carbon	FFP2 folding mask with valve		15 PC	12 boxes	164
8763310	uvex silv-Air 3310	FFP3 folding mask with valve		15 PC	12 boxes	165
8787212	uvex silv-Air 7212	FFP2 preformed mask with valve		15 PC	9 boxes	161
8787232	uvex silv-Air 7232 High-Performance	FFP2 preformed mask with three-chamber system		3 PC	12 boxes	160
8787233	uvex silv-Air 7233 High-Performance	FFP2 preformed mask with three-chamber system		3 PC	12 boxes	160
8787312	uvex silv-Air 7312	FFP3 preformed mask with valve		5 PC	12 boxes	161
8787317	uvex silv-Air 7317	FFP3 preformed mask with valve		5 PC	12 boxes	161
8787318	uvex silv-Air 7317	FFP3 preformed mask with valve		80 PC	1 carton	161
8787330	uvex silv-Air 7330 High-Performance	FFP3 preformed mask with three-chamber system		3 PC	12 boxes	160
8787333	uvex silv-Air 7333 High-Performance	FFP3 preformed mask with three-chamber system		3 PC	12 boxes	160
8788313	uvex silv-Air 8313	FFP3 folding mask with valve		15 PC	24 boxes	160
8739518	uvex silv-Air 9517	FFP2 folding mask without valve, with ear bands		10 PC	30 boxes	166
8739519	uvex silv-Air 9517	FFP2 folding mask without valve, with ear bands		1000 PC	1 carton	166
8739520	uvex face mask white	uvex medical face mask type IIR		50 PC	20 boxes	167
8739521	uvex face mask beige	uvex medical face mask type IIR		50 PC	20 boxes	167
8739522	uvex face mask grey	uvex medical face mask type IIR		50 PC	20 boxes	167
8739523	uvex face mask blue	uvex medical face mask type IIR		50 PC	20 boxes	167
8739524	uvex face mask green	uvex medical face mask type IIR		50 PC	20 boxes	167



Disposable
Protective Clothing

uvex

uvex 5/6 air

ISO 15848-1 EN 13034 EN 1149-5 EN 9179-2

Type 5 Type 6

Disposable Protection Clothing

Guide to standards and products

		uvex 5/6 air	uvex 5/6 air	uvex 5/6 comfort light	uvex 5/6 comfort	uvex 5/6 classic light	uvex 5/6 classic	uvex 4B	uvex 3B chem light	uvex 3B chem classic
		98173	89976	88497	98710	17595	98449	98375	89843	89880
EN 14605	Liquid-tight coveralls								■	■
EN 14605	Spray-tight coveralls							■	■	■
EN 13034	Limited spray-tight coveralls (protection against liquid mist)	■	■	■	■	■	■	■	■	
ISO 13982-1	Particle-tight coveralls (protection against solid particles)	■	■	■	■	■	■	■	■	■
EN 1149-5	Protective clothing with antistatic properties (antistatic function only guaranteed if air humidity > 25%)	■	■	■	■	■	■	■	■	■
EN 14126	Protective clothing against infective agents					■	■	■	■	■
EN 1073-2	Protective clothing against particulate radioactive contamination (no protection against radioactive rays)	■	■	■		■	■	■	■	■
DIN 32781	Protective clothing against pesticides							■		
ISO 27065	Protective clothing for use with pesticides								■	

For more detailed information, please see the relevant certificates, technical data sheets or the endorsement on the product!

Defining environmental conditions

Are you exposed to dusty, damp or wet conditions during your work? To make it easier for you to select the right clothing for the job, we've categorised our overalls depending on their suitability for these environments. The bars indicate how suitable the product is for each setting. We also provide information on breathability so that you can take wearer comfort into account in your decision.

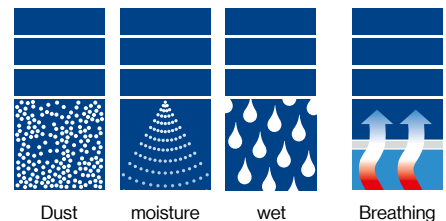

Identifying additional characteristics

In some work environments, there are additional requirements that you will need to take into account. These symbols indicate whether the items are free from silicone and paint wetting impairment substances.



Disposable protective clothing

Type 4 and Type 5/6 features and technologies

1

3 pieced hood

- optimum fit
- no limitations of view
- perfect match with respirators and goggles
- soft elastic on edge, feels comfortable

2

Zipper flap

- Zipper flap with integrated self adhesive tape
- easy to gum up
- additional security

3

Fingerloop

- finger loops made of soft elastic
- to keep the sleeves at the wrist
- additional security

4

Elastic in waistband

- integrated elastic in waist for optimal fit
- ideal wearer comfort

5

elasticated bands on arm and legs

- convenient closures thanks to elastics at wrist and ankles for additional security
- soft elastic on edge for high wearer comfort



Technologies

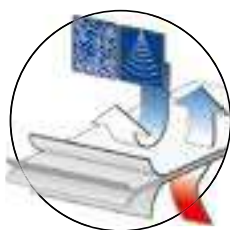

uvex SMS

- build out of several layers of polypropylene non woven material
- Mixture of spunbond and melt-blown non woven material for a perfect balance between stability and softness
- High degree on air permeability and breathability



uvex com4-Laminat

- non woven polypropylene material laminated with a microporous polyethylene film
- non woven material on the inside for a comfortable feeling
- material is not sticking on skin
- the microporous film provides a certain level on breathability

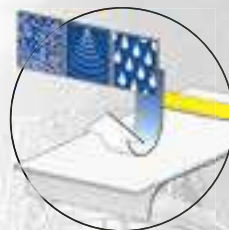

uvex Laminat light

- non woven polypropylene material laminated with a polyethylene film
- non woven material on the inside for a comfortable feeling
- material is not sticking on skin
- using the film is providing a higher level of protection, but reduces the breathability



uvex Laminat classic

- non woven polypropylene material laminated with a polypropylene film
- non woven material on the inside for a comfortable feeling
- material is not sticking on skin
- the polypropylene film provides an effective barrier against many organic and inorganic liquid chemicals

uvex 3B chem classic

Disposable coverall chemical protection Type 3B



89880

uvex 3B chem classic

General features:

- highly durable material combined with ultrasonically welded and taped seams ensure a great barrier and maximum of safety
- lightweight and durable material
- skin-friendly textile grip on inside

Protection features:

- offers protection against a wide range of chemicals
- optimal protection thanks to self-adhesive zipper flap

Comfort features:

- elasticated waistband, elasticated bands on hood, arms and legs for a perfect fit
- middle finger loops prevent sleeves sliding up the arm

Areas of application:

- handling organic and inorganic chemicals
- cleaning and maintenance work
- chemical and pharmaceutical industries
- food industry
- remediation of soil contamination and dismantling
- industrial cleaning and maintenance
- tank cleaning
- work with paints and varnishes
- disposal of hazardous materials
- agricultural industry
- waste water treatment and drainage construction
- waste management
- disaster response and emergency services
- veterinary medicine and disease control
- oil and petrochemicals

Certified in acc. with



TYPE 3B

TYPE 4B

TYPE 5B

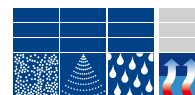

uvex 3B chem classic	
Art. no.	89880
Material	polypropylene spunbond, laminated with polypropylene film
Colour	yellow
Sizes	S to 3XL
Order unit	PC
Outer packaging	25 PC per CT



uvex-safety.com/en/overalls

uvex 3B chem light

Disposable coverall chemical protection Type 3B



89843

uvex 3B chem light

General features:

- light and highly flexible material for high wearer comfort with skin-friendly non-woven material inside

Protection features:

- ideal for cleaning work
- optimal protection thanks to self-adhesive zipper flap

Comfort features:

- elasticated waistband, elasticated bands on hood, arms and legs for optimal fit
- middle finger loops for securing the sleeves

Areas of application:

- handling low-concentration chemicals
- industrial and building cleaning
- ship building and automobile manufacture
- chemical and pharmaceutical industries
- handling paints and varnishes
- electronics
- handling and dismantling of asbestos
- remediation of contaminated sites
- livestock breeding and veterinary medicine
- waste management



Stitched and taped seams. Optimum protection against penetration by liquid aerosols and solid particles.

Certified in acc. with

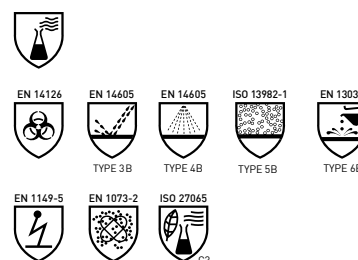

uvex 3B chem light	
Art. no.	89843
Material	polypropylene spunbond laminated with polyethylene film
Colour	white, yellow
Sizes	S to 3XL
Order unit	PC
Outer packaging	40 PC per CT

The chemicals included in this list are examples only. For a full overview for each individual garment, please consult the technical datasheets. You can also search our Chemical Expert System (see page 183).

Chemical	CAS no.	89843	89880
		Class in acc. EN 14325	Class in acc. EN 14325
Acetone	67-64-1	6 of 6	1 of 6
Acetonitrile	75-05-8	6 of 6	0 of 6
Iron(III) chloride (aq., 45%)	7705-08-0	–	6 of 6
Hydrofluoric acid (aq., 49%)	7664-39-3	6 of 6	6 of 6
Hydrofluoric acid (aq., 71 to 75%)	7664-39-3	–	5 of 6
Hydrofluoric acid in urea (62 to 64%)	7664-39-3	–	2 of 6
Formaldehyde (aq., 10%)	50-00-0	–	6 of 6
Isopropanol	67-63-0	6 of 6	6 of 6
Methanol	67-56-1	6 of 6	6 of 6
Sodium hydroxide, 50%	1310-73-2	6 of 6	6 of 6
Nitric acid, 69.5%	7697-37-2	–	6 of 6
Hydrochloric acid (aq., 37%)	7647-01-0	5 of 6	6 of 6
Sulphuric acid, 96%	7664-93-9	6 of 6	6 of 6
Hydrogen peroxide	7722-84-1	6 of 6	6 of 6

The information provided in the table was obtained in tests conducted under laboratory conditions (at temperatures of 21 ± 2°C). As additional stresses, such as higher temperatures and mechanical influences, are often present in practice, these values serve as a guide only. The information is provided without obligation and is not intended to replace your own suitability tests.

uvex

uvex 4B · uvex 3B chem light

Protection against pesticides – DIN 32781 / ISO 27065

In farming and forestry applications, workers are repeatedly exposed to hazardous chemical and biological substances.

Depending on the type of application, the duration of the exposure and the specific effects of the hazardous substance, it may be necessary to wear personal protective equipment.

In addition to respiratory protection and gloves, appropriate chemical protection clothing is an important component of the wearer's protective equipment.



You can find detailed information about this topic in our related blog post

uvex 4B

Disposable coverall chemical protection type 4B



98375



89094



Stitched and taped seams. Optimum protection against penetration by liquid aerosols and solid particles.



uvex 4B

General features:

- light and highly flexible material for high wearer comfort lined with skin-friendly non-woven material inside

Protection features:

- taped seams for optimal protection
- self-adhesive zipper flap for optimal protection

Comfort features:

- elasticated waistband, elasticated bands on hood, arms and legs for optimal fit
- middle finger loops prevent sleeves sliding up the arm

Areas of application:

- low-pressure industrial cleaning and building cleaning
- ship building and automobile manufacture
- chemical and pharmaceutical industries
- handling paints and varnishes
- agriculture and horticulture
- pest control
- electronics
- work with asbestos and dismantling
- remediation of contaminated sites
- pharmaceutical industry and laboratories
- sampling
- livestock breeding and veterinary medicine
- waste management

Certified in acc. with

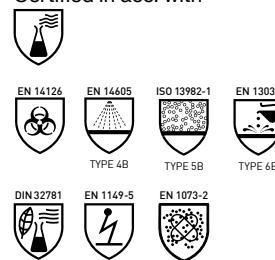

	uvex 4B	uvex 4B with overshoes
Art. no.	98375	89094
Material	polypropylene spunbond, laminated with polyethylene film	polypropylene spunbond, laminated with polyethylene film
Colour	white, orange	white, orange
Sizes	S to 3XL	S to 3XL
Order unit	PC	PC
Outer packaging	40 PC per CT	40 PC per CT



uvex-safety.com/en/overalls

uvex 5/6 classic

Disposable coverall chemical protection Type 5/6



uvex 5/6 classic

General features:

- extremely lightweight and breathable material guarantees an excellent combination of comfort and safety
- skin-friendly and soft non-woven material on the inside

Protection features:

- self-adhesive zipper flap for optimal protection

Comfort features:

- elasticated waistband, elasticated bands on hood, arms and legs for a perfect fit
- middle finger loops prevent sleeves sliding up the arm

Areas of application:

- handling chemicals in dust and powder form
- varnishing and protection against paint splashes
- fibreglass production and processing
- industrial cleaning and maintenance
- automotive industry
- grinding and polishing
- cement manufacture
- mining and quarrying
- demolition and refurbishment
- working with asbestos
- wood and metal processing
- construction industry
- pharmaceutical industry

► other articles on request

Certified in acc. with

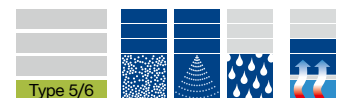
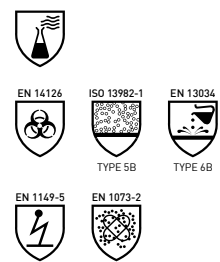

Art. no.	uvex 5/6 classic	uvex 5/6 classic mF	uvex 5/6 classic light
98449		98759	17595
Material	polypropylene spunbond, laminated with polyethylene film	polypropylene spunbond, laminated with polyethylene film	polypropylene spunbond, laminated with polyethylene film
Colour	white	white	white
Sizes	S to 3XL	S to 3XL	S to 3XL
Order unit	PC	PC	PC
Outer packaging	50 PC per CT	50 PC per CT	50 PC per CT

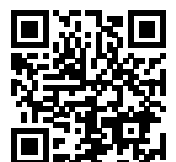

uvex-safety.com/en/overalls

uvex 5/6 comfort

Disposable coverall chemical protection Type 5/6



98710



88497



98710: Breathable polyethylene laminate combined with an air permeable SMS back section to provide a high level of moisture management and breathability.



88497: Breathable polyethylene laminate combined with an air permeable SMS back section to provide a high level of moisture management and breathability.



uvex 5/6 comfort

General features:

- the combination of polyethylene laminate and a SMS back section provides a high level of moisture management, without reducing protection

Protection features:

- 98710: bound seams in contrasting colour
- 88497: with inside overlock seam
- self-adhesive zipper flap for optimal protection

Comfort features:

- optimal fit with elasticated waistband, elasticated bands on the hood, arms and legs
- middle finger loops prevent sleeves sliding up the arm

Areas of application:

- handling chemicals in dust and powder form
- varnishing and protection against paint splashes
- fibreglass production and processing
- industrial cleaning and maintenance
- automotive industry
- grinding and polishing
- cement manufacture
- mining and quarrying
- demolition and refurbishment
- working with asbestos
- wood and metal processing
- construction industry
- cleanroom applications
- pharmaceutical industry

Certified in acc. with



TYPE 5

TYPE 6

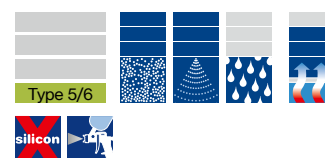

	uvex 5/6 comfort	uvex 5/6 comfort light
Art. no.	98710	88497
Material	Main material: polypropylene spunbond, laminated with polyethylene film back: SMS spunbond	Main material: polypropylene spunbond, laminated with polyethylene film back: SMS spunbond
Colour	white, lime	white
Sizes	S to 3XL	S to 3XL
Order unit	PC	PC
Outer packaging	40 PC per CT	40 PC per CT

uvex 5/6 air

Disposable coverall chemical protection Type 5/6



98173



89976



uvex 5/6 air

General features:

- excellent moisture management
- ideal for warm working environments and extended periods of wear

Protection features:

- optimal protection in dusty environments
- self-adhesive zipper flap for optimal protection

Comfort features:

- optimal fit with elasticated waistband, elasticated bands on hood, arms and legs
- middle finger loops prevent sleeves sliding up the arm

Areas of application:

- handling chemicals in dust and powder form
- working with asbestos
- fibreglass, ceramic fibre and synthetic resin production and processing
- wood and metal processing
- construction industry
- automotive industry
- grinding and polishing
- cement manufacture
- mining and quarrying
- refurbishment and renovation
- pharmaceutical industry
- repair work

Certified in acc. with



ISO 13982-1



TYPE 5

EN 13034



TYPE 6

EN 1149-5



EN 1073-2



uvex 5/6 air	
Art. no.	98173
Material	polypropylene spunbond
Colour	white
Sizes	S to 3XL
Order unit	PC
Outer packaging	50 PC per CT



uvex-safety.com/en/overalls

Disposable chemical protection

Accessories



9875200



9875300



9874946
9874948



9875046



8935346



8909746



8909546



Hood · Gauntlets · Overshoes · Overboots

	Hood	Gauntlets	Overshoes	Overboot
Art. no.	9875200	9875300	9874946 9874948	9875046
Sizes	one size fits all	one size fits all	42 to 46 46 to 48	42 to 46
Version	with velcro fastening	elasticated band on both ends	opening with elasticated band	opening with elasticated band and tie
Material	polypropylene spunbond, laminated with polyethylene film	polypropylene spunbond, laminated with polyethylene film	polypropylene spunbond, laminated with polyethylene film	polypropylene spunbond, laminated with polypropylene film
Colour	white	white	white	white
Order unit	BG	BG	BG	BG
Content	50 PC, loose	50 PR, loose	100 PR, loose	50 PR, loose

	Overboot	Overshoe with anti-slip	Overboots with anti-slip
Art. no.	8935346	8909746	8909546
Sizes	42 to 46	42 to 46	42 to 46
Version	opening with elasticated band and tie	with anti-slip sole, elasticated opening improved fit	with anti-slip sole, elasticated opening with band improved fit
Material	polypropylene spunbond, laminated with polypropylene film	polypropylene spunbond, laminated with polyethylene film	polypropylene spunbond, laminated with polyethylene film
Colour	yellow	white	white
Order unit	BG	BG	BG
Content	30 PR, loose	100 PR, loose	25 PR, loose

Disposable chemical protection

Protection against infectious diseases



Workers may come into contact with biological substances in a wide range of situations. Appropriate personal protective equipment must be used to prevent potential infection.

Clothing designed to provide protection against infectious diseases establishes a physical barrier between the wearer's skin and the source of the infection, and prevents the disease from spreading to other people or environments.

Generally, micro-organisms such as bacteria, fungi and viruses are classed as biological substances. A detailed definition is provided in EU Directive 2000/54/EC. The crucial common denominator between all of these materials is that they can cause infections, trigger allergies, or produce a toxic effect.

Biological substances are placed in one of four categories depending on the infection risk they present:

Risk group 1:
Biological substances that are unlikely to cause disease in humans.

Risk group 2:
Biological substances that can cause human disease and might be a hazard to workers, but are unlikely to spread to the community; there is usually effective prophylaxis or treatment available.

Risk group 3:
Biological substances that can cause severe human disease and present a serious hazard to workers; they may present a risk of spreading to the community, but there is usually effective prophylaxis or treatment available.

Risk group 4:
Biological substances that cause severe human disease and are a serious hazard to workers; they may present a high risk of spreading to the community, and there is usually no effective prophylaxis or treatment available.

The risk groups of each biological substance are described in detail in the annex to EU Directive 2000/54/EC.

- Typical applications in which workers may be exposed to infectious substances include:
- Waste water treatment and drainage work
 - Waste disposal
 - Agriculture
 - Food industry
 - Work that involves contact with animals and/or products of animal origin
 - Healthcare, hospitals, emergency services

A detailed list of all biological substances that you may be exposed to in various applications, and the potential diseases associated with these substances, can be found in a number of publications, including the BGIA Report 1/2013.

Protective clothing in accordance with EN 14126:2003

The EN 14126 standard defines the performance requirements for clothing designed to protect against infectious diseases. The defined test procedures focus on the medium that contains the micro-organisms, such as fluids, aerosols or solid dust particles. Due to the heterogeneous nature of the micro-organisms, it is not possible to define performance criteria for them.

The tests stipulated by the standard relate only to the material; seam technologies are not taken into account. Taped seams provide a higher level of protection, as the micro-organisms are small enough to penetrate through the tiny needle holes along the seam.

The entire protective suit must also be certified as chemical protection clothing (see page 183).

Wearing appropriate protective clothing does not provide complete, guaranteed protection against all chemical risks. It is also essential that you put on and remove the PPE correctly to ensure safety (see page 184). Any person who assists in the removal of the clothing is also exposed to the risk of contamination.

Model	uvex 3B chem classic	uvex 3B chem light	uvex 4B	uvex 5/6 classic	uvex 5/6 classic light
Art. no.	89880	89843	98375, 89094	98449	17595, 17596
ISO/FDIS 16604/16603 Resistance to contaminated liquids	6 of 6	6 of 6	6 of 6	6 of 6	6 of 6
EN 14126 appendix A Resistance due to mechanical contact with substances containing contaminated liquids	6 of 6	6 of 6	6 of 6	6 of 6	6 of 6
ISO/DIS 22611 Resistance to contaminated liquid aerosols	3 of 3	3 of 3	3 of 3	3 of 3	3 of 3
ISO/DIS 22612 Resistance to contaminated solid particles	3 of 3	3 of 3	3 of 3	3 of 3	3 of 3

Disposable Protection Clothing

Guide to standards and products

Your team's safety at the forefront

From light liquid splashes to hazardous chemicals and radioactive material – employees face various hazards in the course of their daily work. To simplify the process of selecting appropriate protective clothing, the European Union has defined harmonised standards for different protection classes (also called types) for chemical protection – Category III.

The protection type is confirmed by certification and indicates the kind of exposure (dust, liquid, gas) for which the suit is suitable. The attainment of the individual types only ensures the minimum requirements necessary for certification. Please refer to our technical datasheets for details of the individual tests.

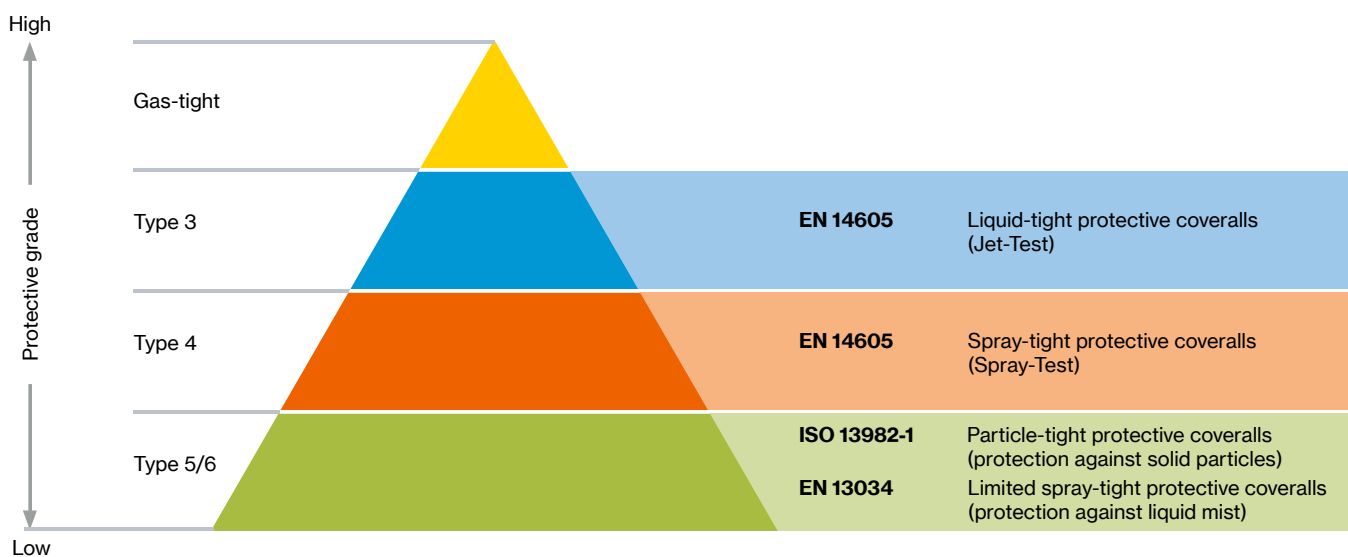

For optimum protection of your team at all times, the breakthrough times of permeation must be taken into account for protective coveralls. uvex protection clothing has undergone the required permeation tests. More information on the breakthrough times of specific chemicals can be found in the technical datasheets or in the uvex Chemical Expert System

Online chemicals database

The uvex Chemical Expert System (CES) offers an extensive chemicals database for choosing the appropriate disposable overall for working with hazardous substances.

As a user, you can create a personal permeation list or receive advice from our specialists. It only takes a few clicks of the mouse to find the right disposable safety clothing and chemical safety gloves to match your specific requirements.

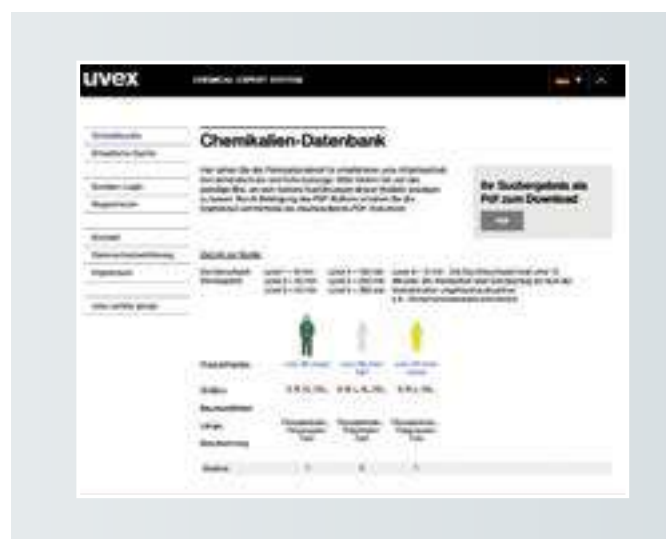

<https://ces.uvex.de>

The breakthrough times were determined under laboratory conditions. As additional stresses, such as higher temperatures and mechanical influences, are often present in practice, this information serves as a guide only. Following contamination, wear or damage, the coverall is to be removed immediately and properly disposed of.

Disposable chemical protection

Guidelines for use

Tips for putting on and taking off



Instructions for putting on and taking off Type 3B (PDF)

Instructions for putting on



Instructions for taking off



Instructions for putting on and taking off Type 5/6 (PDF)

Instructions for putting on/
taking off



Information on selecting the correct size of disposable protective suit

To ensure an optimum fit and keep the wearer safe when working with hazardous substances, uvex disposable overalls are available in multiple sizes. However, the correct size may not be the same as your usual clothing size. Use the following overview to find the correct fit based on your height and chest circumference.

Body height in cm	Chest circumference in cm	Size to choose
164 - 170 cm	84 - 92 cm	S
170 - 176 cm	92 - 100 cm	M
176 - 182 cm	100 - 108 cm	L
182 - 188 cm	108 - 116 cm	XL
188 - 194 cm	116 - 124 cm	XXL
194 - 200 cm	124 - 132 cm	XXXL

Selecting the correct chemical-protection clothing

In order to select appropriate chemical-protection clothing for a specific application within your business, it is important to have your overalls tested by a trained safety officer. Many chemicals can cause serious or irreversible injury to workers if they are not adequately protected. For this reason, chemical-protection clothing should be selected with great care.

Note: It is the responsibility of the user to decide for themselves whether the protective suit used is suitable and correct for the intended use. uvex accepts no responsibility whatsoever in the event of improper use and application of these products.

Proper handling of uvex disposable protective clothing

Storage

uvex disposable protective clothing must be stored in its original packaging, away from light and in a dry environment at temperatures of 15°C–25°C. The products must be disposed of after use in accordance with the respective legal requirements.

Washing disposable protective suits

Disposable overalls are for single use only and must not be washed.

Durability

It is recommended to use the product within five years from the production date, which can be found on the label.

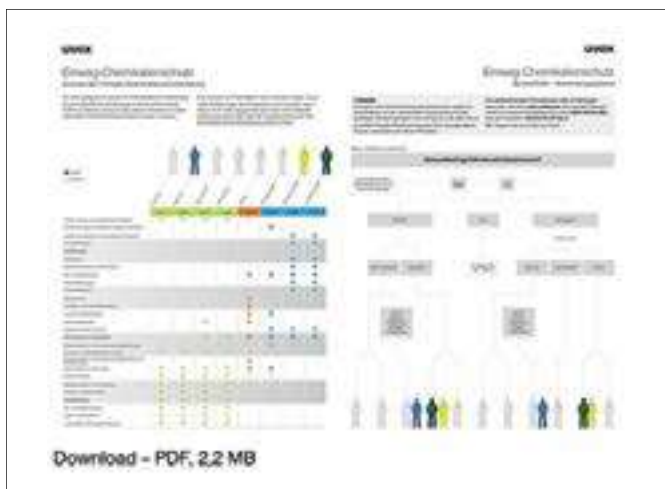

Download - PDF, 2,2 MB



uvex-safety.com/en/overalls



Safety Gloves

protecting planet

To help raise awareness of its commitment to achieving increased sustainability, uvex has developed the **protecting planet** icon.

For uvex, **protecting planet** is more than a label. Based on the brand claim, **protecting people**, our sustainable approach integrates three core interlinked pillars – **ecology, economy** and **social responsibility**, that are incorporated throughout the business to improve our sustainability performance.

This explains the comprehensive audit, measurement and evaluation management process uvex undertakes along the entire value chain to ensure its products are as sustainable as possible.



uvex Bamboo TwinFlex®
D xg planet

The **uvex Bamboo TwinFlex® D xg planet** is an example of the **planet series** product system.



protecting planet

by using bio-based material //
by using recycled material //
by maximum reduction of pollutants

By using bamboo viscose uvex is utilising a renewable raw material and recycled polyamide. Together, these sustainable materials account for 45 percent of the material used. The gloves also offer greater protection to the health of the wearer than stipulated by REACH regulations as they comply with the uvex list of banned substances and the skin compatibility has been dermatologically approved by the proDERM institute.



protecting planet

by using environmentally-friendly packaging

The glove packaging has been minimised significantly. Paper wrap is used instead of rubber bands to secure bundles. Polyester bags have not been used by uvex in its glove packaging for over 11 years.



protecting planet

by having a CO₂ neutral production

uvex safety gloves is certified according to both Environmental Management ISO 14001 and Energy Management ISO 50001 and has CO₂-neutral production rating based on direct emissions from production. To achieve this, we have been sourcing electricity from 100 percent renewable energy sources since 2014, and through the certified green electricity product we have been promoting the construction of new renewable energy plants in the region. We use green gas to operate the highly efficient CHP plant at our site, thereby offsetting the CO₂ emissions produced by gas combustion processes. Through carbon offsetting, we invest exclusively in climate protection projects that are certified by internationally recognised quality standards (Gold Standard or VCS (Verified Carbon Standard)) and thereby promote, for example, the construction of new plants in India for the generation of solar and wind power.



Innovative safety gloves “Made in Germany”

Manufacturing and technology expertise



Video



uvex hand protection centre of expertise in Lüneburg

A fully integrated development process, state-of-the-art robot-controlled plant technology and strict production controls guarantee that our safety gloves are of first-class quality. Production in Germany ensures sustainable, resource-saving production and short distances from manufacturer to end user.

Sustainable production:

- CO2-neutral production
- Solvents and plasticisers not used in production
- Sustainable environmental and energy management (ISO 14001/ISO 50001)
- Made locally in Germany



Social responsibility:

- Full implementation of the ILO standard
- Continuous social audits at partner companies (uvex social standard)
- Social engagement with a focus on disadvantaged children



Health:

- Over-compliance with REACH regulations on eliminating harmful substances
- Ongoing analysis of almost 200 critical substances (uvex harmful substances standard)
- Certified in line with Oeko-Tex® Standard 100
- DERMA-certified free from allergenic substances



Comfort:

- Extremely comfortable thanks to the use of breathable natural and functional fibres
- Optimum tactile feel thanks to an ergonomic fit
- Natural feel against the skin



MADE IN GERMANY

Quality management

Energy management

Environmental management

Extensive know-how is part of our service

Service expertise



We know exactly what you want.

Our expertise is available for you at all times which forms the basis of our on-site. Risk-hazard analysis service: Our hand protection specialists work with you to determine which safety gloves are best suited to your individual requirements. Seminars, laboratory analyses and online tools round off our service portfolio.

Fully integrated development processes

- own yarn/liner manufacturing
- own compounding (blending)
- specially developed moulding and process technology
- innovative coating technology
- development of customer-specific solutions
- technical modifications to existing products (e.g. thermal lining)
- individual production (e.g. gloves for disabled people)

Consultation / training / application technology

- on-site consultation from uvex product specialists
- practical hand protection seminars (uvex academy)
- plant and laboratory tours for customers
- cooperation with scientific institutes
- measurement and analysis service in own laboratories
 - mechanical standard test in accordance with EN 388
 - permeation tests in accordance with EN 374
 - special tests (e.g. antistatic/grip measurement/ climate test)
- individual certifications (e.g. for ingredients, coating compatibility, food product suitability)



Information / e-services

- Chemical Expert System (CES)
- designer glove plan
- online glove navigator
- online product data sheets
- online declaration of conformity

For further information, please visit:
www.uvex-safety.de/usglfilm

Safety Gloves

Mechanical Risks / Special risks



Precision work

uvex phynomic



Page 200	Page 201	Page 201	Page 201	Page 202	Page 202	Page 202	Page 203	Page 203	Page 204	Page 204
uvex phynomic airLite A ESD	uvex phynomic foam	uvex phynomic allround	uvex phynomic XG	uvex phynomic x-foam HV	uvex phynomic wet	uvex phynomic wet plus	uvex phynomic pro	uvex phynomic pro 2	uvex phynomic lite	uvex phynomic lite w

uvex rubipor



Page 205	Page 205
uvex rubipor XS	uvex rubipor XS

uvex athletic



Page 205	Page 206	Page 206	Page 206
uvex athletic allround	uvex athletic lite	uvex athletic lite ESD	uvex athletic lite dry

uvex unilite



Page 207	Page 207
uvex unilite 6605	uvex unilite 7700

uvex unipur



Page 207	Page 208	Page 208	Page 208	Page 208	Page 209	Page 209
uvex unipur 6634	uvex unipur 6630	uvex unipur 6631	uvex unipur 6639	uvex unipur carbon	uvex unipur carbon FT	

uvex unigrip



Page 209	Page 209
uvex unigrip 6624	uvex unigrip 6620



Allround

uvex profi



Page 210	Page 210	Page 210	Page 211	Page 211
uvex contact ergo ENB20C	uvex profi ergo ENB20A	uvex profi ergo ENB20	uvex profi ergo XG20A	uvex profi ergo XG



Page 211
uvex glove clip



Heavy Duty



Page 212	Page 212	Page 212	Page 212
uvex rubiflex	uvex unilite 7710 F	uvex compact NB27E	uvex compact NB27H



Heat protection



Page 213	Page 213	Page 213
uvex nk	uvex k-basic extra	uvex profatherm



Cold protection

uvex unilite thermo



Page 214	Page 214	Page 214	Page 214
uvex unilite thermo	uvex unilite thermo plus	uvex unilite thermo HD	uvex unilite thermo plus cut c



Working on live parts



Page 215	Page 215
uvex power protect V1000	uvex arc protect g1

Safety Gloves

Cut protection

uvex D500 / uvex C500				uvex C500						uvex C300			
Page 219	Page 220	Page 220	Page 221	Page 221	Page 221	Page 221	Page 222	Page 222	Page 222	Page 222	Page 223	Page 223	Page 223
uvex Bamboo Twinflex® D xg	uvex D500 foam	uvex C500 M foam	uvex C500 sleeve	uvex C500	uvex C500 wet plus	uvex C500 XG	uvex C500 dry	uvex C500 foam	uvex C500 wet		uvex C300 dry	uvex C300 foam	uvex C300 wet

Cut protection

uvex phynomic				uvex athletic			uvex unidur							
Page 224	Page 225	Page 225	Page 225	Page 226	Page 226	Page 227	Page 228	Page 228	Page 228	Page 229	Page 229	Page 227	Page 227	
uvex phynomic airLite B ESD	uvex phynomic airLite C ESD	uvex phynomic C3	uvex phynomic C5	uvex athletic B XP	uvex athletic C XP	uvex athletic D5 XP	uvex unidur 6641	uvex unidur 6648	uvex unidur 6649	uvex unidur 6643	uvex unidur 6659 foam	uvex unidur sleeve C	uvex unidur sleeve C TL	

Chemical Risks

Safety gloves with textil support - Coating: Nitrile

uvex rubiflex						uvex u-chem				uvex protector	
Page 232	Page 232	Page 232	Page 233	Page 233	Page 236	Page 234	Page 234	Page 234	Page 235	Page 238	Page 238
uvex rubiflex S	uvex rubiflex SZ	uvex rubiflex SZ	uvex rubiflex S XG	uvex rubiflex S	uvex rubiflex ESD	uvex u-chem 3300	uvex u-chem 3200	uvex u-chem 3100	uvex u-chem 3500	uvex protector chemical	uvex protector chemical

Safety gloves without textil support

Page 239	Page 239	Page 237	Page 237
uvex profastrong NF33	uvex profapren CF33	uvex profabutyl B-05R	uvex profaviton BV-06

Disposable safety gloves

uvex u-fit			
Page 241	Page 241	Page 241	Page 241
uvex u-fit strong N2000	uvex u-fit	uvex u-fit ft	uvex u-fit lite

HexArmor gloves

Page 246 - 255	



Table of contents

Standards and product advice

International standards for safety gloves

International standards for safety gloves		Page
DIN EN 388:2016-03	Safety gloves to protect against mechanical risks	194
DIN EN ISO 374-1:2018-10	Safety gloves to protect against dangerous chemicals and micro-organisms	195
DIN EN 16350:2014-07	Safety gloves to protect against electrostatic characteristics	197
DIN EN 60903:2003	Live working - Gloves of insulating material	197
DIN EN 61482-1-2:2015-08	Working with high voltage - Clothing that protects against the thermal hazards of an electric arc – part 1-2	197
DIN EN 407:2020-06	Safety gloves and other protective hand equipment designed to protect against thermal risks (heat and/or fire)	196
DIN EN 511:2006-07	Safety gloves to protect against the cold	196
	Suitable for use with foods (glove materials)	194

We help you choose the right safety gloves for your needs

Discover all our helpful services on our website		Page
1	uvex Glove Navigator - The fast route to finding the right gloves for you	230
2	uvex Chemical Expert System - Chemicals database, permeation lists - uvex glove plan designer	230

uvex – consultation and product expertise from a single source

These pictograms in our catalogue help you to choose the perfect safety glove.

1. Select the risk potential

What is the main risk for users in the workplace?



2. Determine your individual requirements

What type of activity are the safety gloves being selected for?



3. Defining environmental conditions

Are the activities in wet/oily or more humid or dry working environments?
The bars indicate how suitable the product is for each setting.

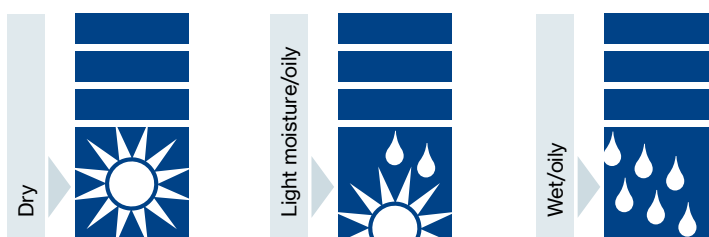

<p>OEKO-TEX® CONFIDENCE IN TEXTILES STANDARD 100 S02-0648 HOHENSTEIN HTTI Tested for harmful substances, www.oeko-tex.com/standard100</p>	<p>MADE IN GERMANY </p>	<p>clima zone</p>
<p>Textiles tested for pollutants</p>	<p>Produced in Germany</p>	<p>Breathability for high wearer comfort</p>
<p>Dermatologically tested for skin compatibility</p>	<p>Can be used with touchscreens</p>	<p>Bamboo TwinFlex® technology for safety (cut protection) and comfort (bamboo fibre)</p>

Detailed information on the award criteria of the certificate issuers can be found at: uvex-safety.com/certificates

Standards

EN 388:2016+A1:2018

Standard for safety gloves to protect against mechanical risks

EN 388:2016 contains various test methods for comparing the mechanical performance of gloves. This standard focusses on the following six performance levels:

EN 388:2016

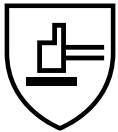

4 X 3 2 D P

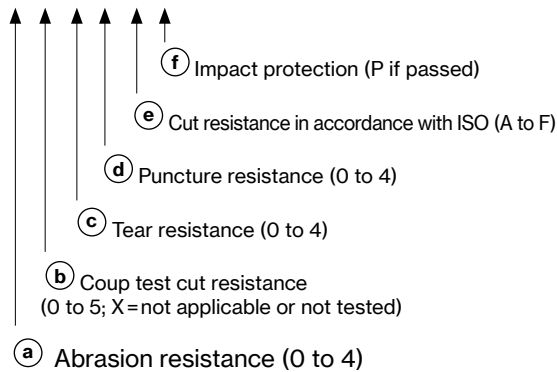

Video



(a) Abrasion resistance

To test the abrasion resistance of the safety glove, the material is rubbed with abrasive paper under pressure. The number of cycles required to grind a hole into the material is used as a reference value. (Highest performance class 4 = 8000 cycles)

(b) Cut resistance by means of the coupe test

A rotating circular knife is used to test the cut resistance of a safety glove. The knife cuts through the glove material at constant speed and constant force. The reference value is the comparison with a reference material and a resulting index. (Highest performance class 5 = index 20)

(c) Tear resistance

To test the tear resistance of the safety glove, the material is first cut. The reference value is the force required to tear the material. (Highest performance class 4 = 75 newtons)

(d) Puncture resistance

To test the puncture resistance, the material to be tested is pierced with a nail (defined dimension). The force used for this is used as a reference value.

(e) Cut resistance according to TDM

The application of the test method in accordance with ISO 13997 is relevant for materials that blunt the rotating circular knife during the coupe test (see above). The required force for cutting a material is measured at a defined distance (20 mm) (highest performance class F= 30 newton)

(f) Additional impact protection

Gloves with performance class "P" at the end offer specific impact absorption.

Suitability grades

Safety gloves for working with food must be designed in such a way that absolutely no components can be transferred to food which may

pose a hazard to human health (migration) under normal and predictable conditions.



Area of application	Aqueous pH > 4.5	Acidic pH < 4.5	Alcoholic	Fatty	Dry, non fatty
Examples	Non-alcoholic beverages Fruit Eggs Vegetables Crustaceans	Vinegar Yeast Milk Yoghurt	Wine Spirits Liqueurs	R1 = olive oil R2 = butter, margarine R3 = fish, cheese, baked goods R4 = meat, poultry R5 = sandwiches fried food	Bread Pasta Rice Tea Spices Pulses
uvex Bamboo TwinFlex® D xg	YES	YES	YES	YES (R1 – R5)	YES
uvex phynomic airlite A ESD	YES	YES	YES	YES (R1 – R5)	YES
uvex profi ergo/ uvex contact ergo	YES	YES	YES	YES (R1 – R5)	YES
uvex phynomic C3/ uvex phynomic C5	YES	YES	YES	YES (R1 – R5)	YES
uvex rubiflex und uvex rubiflex S	YES	YES	YES	YES (R1 – R5)	YES
uvex profastrong NF 33	YES	YES	YES	YES (R2 – R5)	YES
uvex u-fit	YES	YES	YES	YES (R3 – R5)	YES
uvex phynomic foam	YES	YES	YES	YES (R5)	YES
uvex phynomic lite (w)	YES	YES	YES	YES (R1 – R5)	YES
uvex unilite thermo	YES	YES	YES	NO	YES
uvex u-fit strong N2000	YES	NO	YES	YES (R3 – R5)	YES
uvex u-fit lite	YES	NO	YES	YES (R3 – R5)	YES
uvex u-chem 3300	YES	YES	YES	YES (R2 – R5)	YES

EN ISO 374-1:2018 Standard for safety gloves to protect against chemical risks

Chemical safety gloves must meet the requirements of European standard EN ISO 374-1. This standard has undergone fundamental changes in terms of certification.

Test chemicals: From the list of 18 test chemicals, the glove material must be tested for permeation as part of the certification process using 6, 3 or 1 chemical(s), depending on the type class.

Identifier	Test chemical	Group	Class
A	Methanol	polar*	Primary alcohol
B	Acetone		Ketone
C	Acetonitrile		Nitrile
G	Diethylamine		Amine
H	Tetrahydrofuran		Heterocyclic, ether compounds
I	Ethyl acetate		Ester
T	Formaldehyde 37%		Aldehyde
E	Carbon disulphide		Sulphur-containing organic compound
J	n-heptane	aliphatic*	
F	Toluene	aromatic*	
D	Dichloromethane	halogenated*	Chlorinated
L	Sulphuric acid 96%	Acids	Inorganic acid, oxidising
M	Nitric acid 65%		Inorganic acid, oxidising
N	Acetic acid 99%		Organic acid
S	Hydrofluoric acid 40%		Inorganic acid
K	Sodium hydroxide 40%	Bases (alkalis)	Inorganic base
O	Ammonia water 25%		Organic base
P	Hydrogen peroxide 30%	Peroxide (bleach)	Peroxide

* Solvents (hydrocarbons (KWS))

Labelling of safety gloves

EN ISO 374-1:2016/Type A



J K L M N O

Permeation resistance of type A:
at least 30 minutes each with at least 6 test chemicals.

EN ISO 374-1:2016/Type B



J K L

Permeation resistance of type B:
at least 30 minutes each with at least 3 test chemicals.

EN ISO 374-1:2016/Type C



Permeation resistance of type C:
at least 10 minutes each with at least 1 test chemical.

With the uvex Chemical Expert System, uvex provides a multilingual, online platform to search for individual permeation times. In addition, experienced staff are available on-site and in the centre of expertise for safety gloves in Lüneburg to provide advice on all questions relating to safety gloves for protection against chemical risks.

Your uvex account manager will be happy to provide advice.

DIN EN 374-5: 2016 Standard for safety gloves to protect against dangerous chemicals and micro-organisms

To protect against microorganisms such as bacteria, fungi and viruses, safety gloves must undergo and pass special penetration tests in accordance with ISO 16604:2004 (method B). Only then may they be marked with the pictogram for EN ISO 374-5.

Labelling of safety gloves

EN ISO 374-5:2016



Virus

Variant 1:
Protects against bacteria, fungi and viruses

EN ISO 374-5:2016



Variant 2:
Protects against bacteria and fungi

Labelling on the glove



- 1 Name of the manufacturer
- 2 Glove Product Name
- 3 Performance classes, mechanical
- 4 CE conformity mark
- 5 No. of Test Institute
- 6 Letters symbolise test chemicals against which the glove has a protection index of at least class 2.
- 7 Pictogram with designation of standard
- 8 Note enclosed instructions for use
- 9 Glove size
- 10 Expiration date
- 11 Manufacturer address



Permeation

Time measured to penetration	Protection index
> 10 min	Class 1
> 30 min	Class 2
> 60 min	Class 3
> 120 min	Class 4
> 240 min	Class 5
> 480 min	Class 6

Permeation refers to molecular penetration through the safety glove material. The time required by the chemicals to permeate, determines the performance class in accordance with EN ISO 374-1.

The actual period of protection at the workplace may vary depending on real-time process factors.

Standards

EN 407:2020 • DIN EN 511:2016

DIN EN 407:2020 Standard for safety gloves providing protection against thermal risks – heat

The European standard **DIN EN 407** regulates the requirements for safety gloves that provide protection against thermal risks in applications involving heat. Safety gloves certified according to this standard protect the wearer against contact heat, radiant heat and small splashes of molten metal, for example.

However, this does not apply to the specific use of safety gloves in firefighting. According to DIN EN 407, heat protection gloves must have the following features:

- low flammability and low flame propagation
- low heat transmission (protection against radiant, convective and contact heat)
- high temperature resistance

DIN EN 511:2006 Standard for safety gloves providing protection against thermal risks – cold

Cold safety gloves must meet the requirements of the European standard **DIN EN 511**. The certified gloves below are designed to protect the wearer from penetrating ambient cold and from contact cold through direct contact.

Gloves can also be tested for water impermeability in accordance with EN ISO 15383, thus enabling them to protect the hands from wetness and moisture. This test is considered to have been passed if water does not penetrate the safety glove over a 30-minute period.

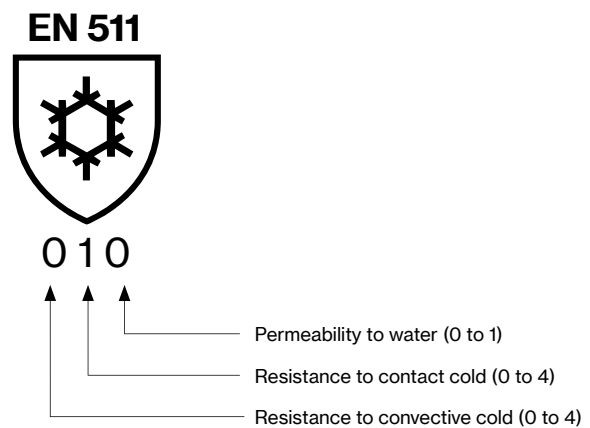
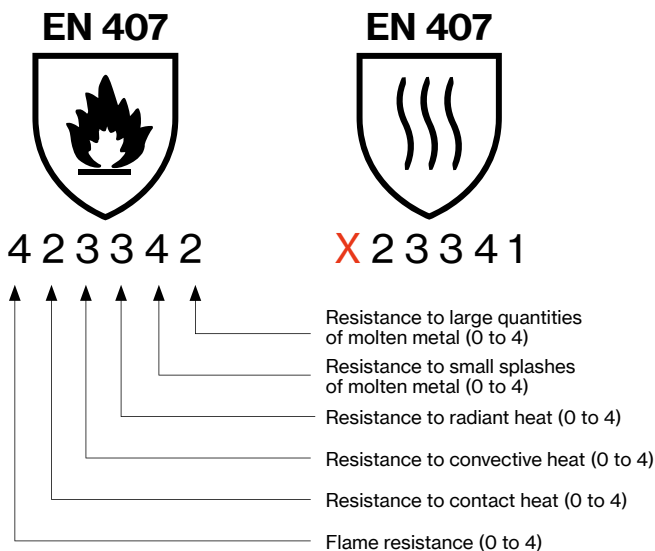

Important changes to standards!

In the latest version of DIN EN 407: As of 2020, the first performance class is no longer named “resistance to flammability”, but is now called “limited flame spread”. If the glove has not been tested for this, a new pictogram is used (see above right). However, there are no changes to the performance classes.

As with mechanical risk protection, the safety glove is assigned a different performance class for each individual aspect. The performance classes are indicated by a number from 0 to 4 next to the pictogram, whereby 4 is the highest performance class.

The test described in DIN EN 407 assigns safety gloves a performance class in relation to each of the individual thermal hazards. It is important that the glove does not come into contact with open flames if it does not meet the criteria of performance class 3 in the limited flame spread test.



DIN EN 16350:2014 Safety gloves – Electrostatic characteristics

The new standard

Choosing the right personal protective equipment (PPE) is particularly important in working environments that are hazardous or harbour health risks. For workplaces at risk of fire and explosive atmospheres, “EN 16350:2014 – Protective gloves – electrostatic properties” is the first European standard to prescribe the test conditions and minimum requirements for electrostatic properties of safety gloves.

- ▶ vertical resistance must be less than $1.0 \times 10^8 \Omega$ ($R_v < 1.0 \times 10^8 \Omega$).
- ▶ test atmosphere: ambient temperature of $23 \pm 1 \text{ }^\circ\text{C}$, relative humidity of $25 \pm 5\%$.

Important notice:

Electrostatic discharge safety gloves are only effective if the wearer is grounded with resistance of less than $10^8 \Omega$.

What should users take into account?

EN 16350:2014 is the first standard to define a limit value for vertical resistance for protective gloves; this value was not included in DIN EN 1149.

Users must therefore check the suitability of the protective gloves in line with EN 16350:2014.

References to EN 1149 are no longer sufficient, as this standard only describes the testing procedure and does not specify a limit value.

ISO 18889 Standard for safety gloves for users of crop protection products

The EN 18889 standard consists of three performance levels – GR, G1 and G2. G2 offers the highest level of protection.



GR: Partially coated safety gloves provide protection against dried spray coatings during follow-up work.



G1: Fully coated safety gloves for handling ready-to-use crop protection products.



G2: Fully coated safety gloves for use with concentrated crop protection products.

DIN EN 60903:2003 Live working – Gloves made from insulating material

DIN EN 60903-compliant safety gloves are category iii PPE. The insulation protection class of the insulating personal protective equipment (PPE) is determined according to the nominal voltage of the plant, with both the maximum permissible nominal AC voltage (AC) and the nominal DC voltage (DC) being calculated.

Labelling of safety gloves

DIN EN 60903



Class 0

Insulation protection class	Max. permissible nominal AC voltage (AC)	Max. permissible nominal direct voltage (DC)
00	500 volts	750 volts
0	1,000 volts	1,500 volts
1	7,500 volts	11,250 volts
2	17,000 volts	25,000 volts
3	26,500 volts	39,750 volts
4	36,000 volts	54,000 volts

Additional identifier

Category	Resistant to
A	Acids
H	Oil
Z	Ozone
C	Extremely low temperatures

DIN EN 61482-1-2:2015-08 Live working - Protective clothing against the thermal hazards of an electric arc

Part 1-2: Test methods – Method 2:

Determining the arc protection class of the material and the clothing using a directed test arc (box test)

Hands are at the greatest risk of burns from short circuit electric arcs when working on electrical equipment. Unfortunately, there is no recognised standard for safety gloves in Germany for testing the potential dangers of a short circuit electric arc. Therefore, safety gloves for protection against the thermal discharge of a short circuit electric arc are generally tested in accordance with EN 61482-1-2 and classified accordingly.

Class	Test current [kA]	Arcing time [ms]	Arc energy [kJ]	Incident energy [kJ/m ²]
1	4	500	168 +/- 17	146 +/- 28
2	7	500	320 +/- 22	427 +/- 39















More on this topic

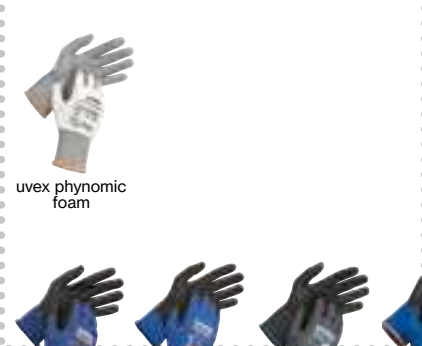

Mechanical Risks

Area of application: precision/all-round

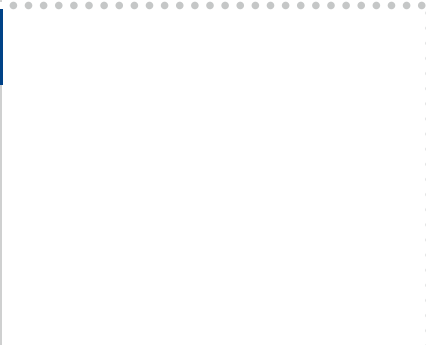
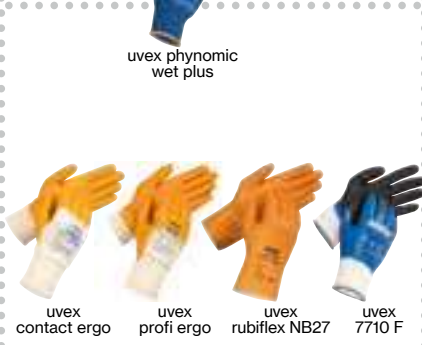
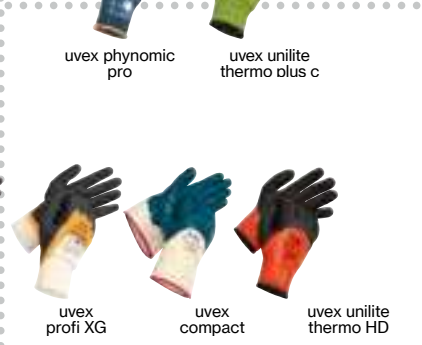
 Precision	 All-round	 Heavy duty
Activities where a high level of sensitivity is necessary.	General, multiple activities for which robust, stable safety gloves are required.	Tough activities requiring highly robust, abrasion resistant safety gloves.
Examples: fine assembly work, working with small parts (e.g. screws), operating controls, end inspection.	Examples: servicing, transport work, light metal processing, standard assembly work, maintenance.	Examples: heavy transport work (e. g. palette transport), construction, servicing.

 dry											
 light moisture / oily											
 wet / oily											
											



Working areas which do not have any moisture (water, oil, fat, cooling lubricant, etc.). Safety gloves for these conditions are extremely breathable. Examples: quality control, assembly work, distribution, end processing.



Working areas with some moisture. Safety gloves for these conditions are less breathable. The water/oil-repelling coating is crucial and also guarantees slip-resistance. Examples: oil-coated parts, changing between dry and damp working environments.



Working areas in which hands should be protected from liquids (not chemicals). Sealed safety gloves with high slip-resistance are necessary. Examples: removing oily/wet parts from machines, outdoor activities (weather-related humidity).

uvex phynomic

Perfection in 3 dimensions

1. Perfect fit



3D ergo technology – precision all the way to the fingertips

- Ergonomic solution for every wearer: up to 8 perfectly coordinated sizes
- The advantages for the wearer:
 - the glove fits like a second skin
 - natural touch
 - maximum flexibility for fatigue-free work

2. Optimum functionality



Coatings perfectly adapted to the application at hand

- for dry areas: aqua-polymer waterproofing
- for dry and slightly damp areas: aqua-polymer foam coating
- for humid and oily areas: aqua-polymer xtra grip foam coating
- for wet and oily areas: aqua-polymer pro coating
- for applications with industrial touchscreen monitors: airLite aqua-polymer foam coating***

3. Skin safe – product safe



Enhanced skin care and product protection

- Health protection
- no skin irritation
 - dermatologically approved*
 - certified in accordance with OEKO-TEX® Standard 100
 - free from harmful solvents (DMF, TEA)
 - free from allergenic substances
- Product protection
- silicone-free according to imprint test
 - suitable for sensitive surfaces
 - does not leave any traces/marks
 - certified for food processes**



clima zone

MADE IN GERMANY

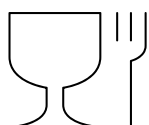

* The uvex phynomic series was clinically tested by the proDERM® Institute for Applied Dermatological Research (Hamburg, Germany). The extremely good skin tolerability of uvex phynomic safety gloves has been dermatologically tested (proDERM® studies: 11.0356-02, 11.0482-11, 13.0202-02, 15.0188-02, 15.0219-11). Detailed information on the award criteria applied by the certification bodies OEKO-TEX® and proDERM can be found at: uvex-safety.com/certificates

** Models uvex phynomic lite/lite w, uvex phynomic foam, uvex phynomic C3 and phynomic C5

*** Models uvex phynomic airLite A ESD, uvex phynomic airLite B ESD, uvex phynomic airLite C ESD

Mechanical Risks

Area of application: precision/all-round

An intelligent future

More and more companies are integrating intelligent methods into their production process. The digitalisation of industrial production (Industry 4.0.) is still on its way. You will be equipped for the future with the uvex phynomic airLite A ESD thanks to its touchscreen compatibility for use on almost all screens, tablets and mobile phones.

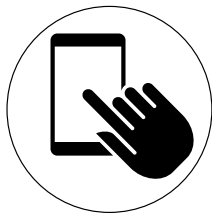

This applies to all products marked with this symbol.

Health protection and the latest uvex coating technology

The newly developed "airLite" aqua-polymer coating in combination with a high-quality liner (18 gauge) offers not only touchscreen compatibility but also the highest sensitivity and tactile feel for precision work when handling very small or fine components.

It has also been tested by the proDERM® institute in an elaborate user-study process and its skin compatibility has been dermatologically approved.



The uvex phynomic airLite ESD range also offers gloves with cut protection in Cut Level B and C. See page 224/225 for details.



60038



MADE IN GERMANY

uvex phynomic airLite A ESD

- the lightest safety glove in its class
- ESD function (DIN EN 16350:2014)
- a noticeable difference in wearer comfort: combination of high sensitivity and tactile feel, lightness and breathability
- touchscreen compatibility for use on almost all screens, tablets and mobile phones
- thin and breathable "airLite" aqua-polymer coating combines the highest sensitivity and tactile feel with touchscreen compatibility
- very good grip in dry and slightly damp areas
- free from accelerators, health protection and skin compatibility dermatologically approved (proDERM®), highly suitable for allergy sufferers
- certified according to OEKO-TEX® Standard 100 (S02-0648 HOHENSTEIN HTTI)

	uvex phynomic airLite A ESD
Art. no.	60038
Design	knitted cuff
Standard	EN 388 (3 110 X), EN 16350
Material	polyamide, elastane, carbon
Coating	palm and fingertips with airLite aqua-polymer coating
Suitable for	for dry and slightly damp areas of application
Colour	black
Sizes	6 to 12
Order quantity multiples	10 PR

You can find more information at www.uvex-safety.com/airlite



Mechanical Risks

Area of application: precision/all-round



60050



60049



60070



uvex phynomic foam

- dexterity safety glove for precision mechanical work
- very good mechanical abrasion resistance thanks to the damp-resistant aqua-polymer foam coating
- good grip in dry and slightly damp areas
- highly breathable coating
- outstanding tactile feel when assembling parts
- free from accelerators, health protection and skin compatibility dermatologically approved (proDERM®), highly suitable for allergy sufferers
- certified according to OEKO-TEX® Standard 100 (S02-0648 HOHENSTEIN HTTI)

	uvex phynomic foam
Art. no.	60050
Design	knitted cuff
Standard	EN 388 (3 1 2 1 X)
Material	polyamide, elastane
Coating	palm and fingertips with aqua-polymer foam coating
Suitable for	dry areas and slightly damp areas
Colour	white, grey
Sizes	5 to 12
Order unit	10 PR

uvex phynomic allround

- light and dirt-resistant all-round safety glove for mechanical activities
- very good mechanical abrasion resistance thanks to the damp-resistant aqua-polymer foam coating
- good grip in dry and slightly damp areas
- highly breathable coating
- outstanding tactile feel when assembling parts
- free from accelerators, health protection and skin compatibility dermatologically approved (proDERM®), highly suitable for allergy sufferers
- certified according to OEKO-TEX® Standard 100 (S02-0648 HOHENSTEIN HTTI)

	uvex phynomic allround
Art. no.	60049
Design	knitted cuff
Standard	EN 388 (3 1 2 1 X)
Material	polyamide, elastane
Coating	palm and fingertips with aqua-polymer foam coating
Suitable for	dry areas and slightly damp areas
Colour	grey, black
Sizes	5 to 12
Order unit	10 PR

uvex phynomic XG

- flexible and extremely durable assembly glove with the best oil grip in its class
- outstanding mechanical abrasion resistance thanks to the aqua-polymer Xtra Grip coating
- outstanding grip in oily areas
- high level of breathability with the porous foam coating
- very good tactile feel when assembling (oily) parts
- free from accelerators, health protection and skin compatibility dermatologically approved (proDERM®), highly suitable for allergy sufferers
- certified according to OEKO-TEX® Standard 100 (S02-0648 HOHENSTEIN HTTI)

	uvex phynomic XG
Art. no.	60070
Design	knitted cuff
Standard	EN 388 (4 1 2 1 X)
Material	polyamide, elastane
Coating	aqua-polymer xtra grip foam coating on palm and fingertips
Suitable for	damp and oily working conditions
Colour	black, black
Sizes	6 to 12
Order unit	10 PR



Mechanical Risks

Area of application: precision/all-round

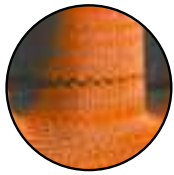

Break section



60054



MADE IN GERMANY



60060



MADE IN GERMANY



60061



MADE IN GERMANY

uvex phynomic x-foam HV

- unique safety glove with break sections
- reduced tear resistance in the finger area with the integration of a seamless break section, which clearly reduces the risk of severe hand injuries when using hand-held power tools
- very good mechanical abrasion resistance thanks to the damp-resistant aqua-polymer foam coating
- good grip in dry and slightly damp areas
- highly breathable coating
- outstanding tactile feel when assembling parts

- free from accelerators, health protection and skin compatibility dermatologically approved (PRO-DERM®), highly suitable for allergy sufferers
- certified according to OEKO-TEX® Standard 100 (S02-0648 HOHENSTEIN HTTI)

NOTE:

- only partially suitable for handling moving machine parts
- a thorough hazard analysis with the support of our uvex hand protection specialists is vital before use

uvex phynomic wet · uvex phynomic wet plus

- safety glove with water-repellent aqua-polymer foam coating for use in outdoor areas
- outstanding mechanical abrasion resistance thanks to the durable coating
- very good grip in damp and wet areas
- high level of breathability due to the coating

- very good tactile feel when assembling parts
- free from accelerators, health protection and skin compatibility dermatologically approved (PRO-DERM®), highly suitable for allergy sufferers
- certified according to OEKO-TEX® Standard 100 (S02-0648 HOHENSTEIN HTTI)

Art. no.	uvex phynomic x-foam HV 60054
Design	knitted cuff
Standard	EN 388 (3 1 X 1 X)
Material	polyamide, elastane
Coating	palm and fingertips with aqua-polymer foam coating
Suitable for	dry areas and slightly damp areas
Colour	orange, grey
Sizes	6 to 12
Order quantity multiples	10 PR

Art. no.	uvex phynomic wet 60060	uvex phynomic wet plus 60061
Design	knitted cuff	knitted cuff
Standard	EN 388 (3 1 3 1 X)	EN 388 (3 1 3 1 X)
Material	polyamide, elastane	polyamide, elastane
Coating	palm and fingertips with aqua-polymer foam coating	palm and 3/4 of the back of the hand with aqua-polymer foam coating
Suitable for	damp and oily working conditions	damp and oily working conditions
Colour	blue, anthracite	blue, anthracite
Sizes	6 to 12	6 to 12
Order quantity multiples	10 PR	10 PR



Mechanical Risks

Area of application: precision/all-round/heavy duty

uvex phynomic pro: comfort made by uvex

In addition to protective function, safety gloves for assembly work must meet a variety of other demands placed on them by the wearer. These include dexterity, a comfortable internal temperature, flexibility and a slip-resistant coating, of which all ensure the gloves do not hinder work.

These requirements are met by a number of safety gloves currently available on the market. However, the workplace often involves a combination of activities, when wearers still need to have an excellent sense of touch even if there is a significant amount of dirt or moisture. If open cell coatings continue to be used in these environments, the hands become dirty, wet or oily as well as reduced product life and regular replacement rates.

This is where uvex's new product concept comes into its own.

The coating: the innovative aqua-polymer-pro coating features dirt and moisture-repellent properties. The gloves are coated up to and including the knuckles. It remains completely flexible and offers exceptional dry and wet grip (in both wet and oily applications).

The liner: uvex has already set new standards in cut protection with the patented Bamboo-TwinFlex® technology. The uvex phynomic pro represents a further ground-breaking development in the Cut 1 segment.

The liner combines bamboo with polyamide/elastane. The dirt and moisture-repellent coating requires that it is particularly important that the fibre combination is absorbent and wicks moisture away from the skin. The silky feel of this fibre also feels pleasant on the skin.

Purity "Made in Germany": This product in the uvex phynomic range has also been tested by the proDERM® Institute to confirm the skin compatibility and dermatological tolerance through a comprehensive process of repeated patch tests and in-use studies.



60064



60062



MADE IN GERMANY

uvex phynomic pro 2 · uvex phynomic pro

- high dexterity and dirt- and damp-resistant safety glove
- good mechanical abrasion resistance thanks to the durable aqua-polymer Pro coating
- very good grip in damp, wet and oily areas
- High breathability and very good moisture absorption thanks to the bamboo viscose liner
- very good tactile feel when handling parts
- outstanding wearer comfort on the skin thanks to the bamboo-polyamide-elastane liner
- free from accelerators, health protection and skin compatibility dermatologically approved (proDERM®), highly suitable for allergy sufferers
- certified according to OEKO-TEX® Standard 100 (S02-0648 HOHENSTEIN HTTI)



	uvex phynomic pro 2 60064	uvex phynomic pro 60062
Art. no.	60064	60062
Design	knitted cuff	knitted cuff
Standard	EN 388 (2 1 2 1 X)	EN 388 (2 1 2 1 X)
Material	bamboo, polyamide, elastane	bamboo, polyamide, elastane
Coating	palm and fingertips with aqua-polymer foam coating	palm and 3/4 of the back of the hand with aqua-polymer pro coating
Suitable for	damp and oily working conditions	damp and oily working conditions
Colour	blue, anthracite	blue, anthracite
Sizes	6 to 12	6 to 12
Order quantity multiples	10 PR	10 PR



Mechanical Risks

Area of application: precision/all-round



60040



60041

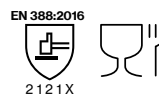
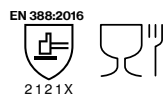

MADE IN GERMANY

uvex phynomic lite · uvex phynomic lite w

- lightweight safety glove for fatigue-free work
- good mechanical abrasion resistance thanks to the very thin but highly durable aqua-polymer impregnation
- good grip in dry and slightly damp areas
- very high level of breathability with the porous coating, which reduces sweating
- outstanding tactile feel when handling small parts
- free from accelerators, dermatologically approved skin compatibility (proDERM®), highly suitable for allergy sufferers
- certified according to OEKO-TEX® Standard 100 (S02-0648 HOHENSTEIN HTTI)

Art. no.	uvex phynomic lite 60040	uvex phynomic lite w 60041
Design	knitted cuff	knitted cuff
Standard	EN 388 (2 1 2 1 X)	EN 388 (2 1 2 1 X)
Material	polyamide, elastane	polyamide, elastane
Coating	palm and fingertips with aqua-polymer impregnation	palm and fingertips with aqua-polymer impregnation
Suitable for	dry and slightly damp areas of application	dry and slightly damp areas of application
Colour	grey, grey	white, white
Sizes	5 to 12	5 to 12
Order quantity multiples	10 PR	10 PR



Mechanical Risks

Area of application: precision/all-round



60276



60316



60028



MADE IN GERMANY

uvex rubipor XS

- lightweight, elastic safety glove with stretch cotton material
- good grip in dry areas
- very high level of breathability with the thin layer of NBR impregnation
- very good tactile feel through the flexible stretch cotton material with elastane
- ergonomic fit

- certified according to OEKO-TEX® Standard 100 (S02-0648 HOHENSTEIN HTTI)

Art. no.	uvex rubipor XS2001 60276	uvex rubipor XS5001B 60316
Design	knitted cuff	knitted cuff
Standard	EN 388 (1110 X)	EN 388 (1110 X)
Material	cotton interlock, elastane	cotton interlock, elastane
Coating	palm and fingertips coated with breathable	palm and fingertips coated with breathable
Suitable for	NBR special impregnation dry areas of application	NBR special impregnation dry areas of application
Colour	white, white	white, blue
Sizes	6 to 10	6 to 10
Order quantity multiples	10 PR	10 PR

uvex athletic allround

- lightweight and dirt-resistant all-round safety glove for mechanical tasks
- very good mechanical abrasion resistance thanks to the damp-resistant aqua-polymer foam coating
- very good grip in dry and slightly damp areas
- perfect fit thanks to the "slim fit" design and elastane with liner
- certified according to OEKO-TEX® Standard 100 (S02-0648 HOHENSTEIN HTTI)



Art. no.	uvex athletic allround 60028
Design	knitted cuff
Standard	EN 388 (4122 X)
Material	polyamide, elastane
Coating	palm and fingertips with NBR foam coating
Suitable for	dry and slightly damp areas
Colour	grey, anthracite
Sizes	6 to 11
Order quantity multiples	10 PR



Mechanical Risks

Area of application: precision/all-round



60027



60035

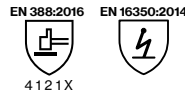

60033

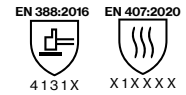

uvex athletic lite

- lightweight and sensitive safety glove for mechanical tasks
- matt, porous and particularly abrasion-resistant microfoam coating
- very good grip in dry and slightly damp areas
- high breathability thanks to the porous coating, reducing sweating
- perfect fit thanks to the “slim fit” design and elastane in the liner
- certified according to OEKO-TEX® Standard 100 (S02-0648 HOHENSTEIN HTTI)

	uvex athletic lite
Art. no.	60027
Design	knitted cuff
Standard	EN 388 (4 1 3 2 X)
Material	polyamide, elastane
Coating	palm and fingertips with NBR foam coating
Suitable for	dry and slightly damp areas
Colour	blue, anthracite
Sizes	6 to 11
Order quantity multiples	10 PR

uvex athletic lite ESD

- lightweight and sensitive safety glove for mechanical tasks, even a little thinner and with higher dexterity than the uvex athletic lite
- touchscreen ability and ESD function according to DIN EN 16350:2014
- matt, porous and particularly abrasion-resistant microfoam coating
- very good grip in dry and slightly damp areas
- high breathability thanks to the porous coating, reducing sweating
- perfect fit thanks to the “slim fit” design and elastane in the liner
- certified according to OEKO-TEX® Standard 100 (S02-0648 HOHENSTEIN HTTI)

	uvex athletic lite ESD
Art. no.	60035
Design	knitted cuff
Standard	EN 388 (4 1 2 1 X), DIN EN 16350:2014
Material	polyamide, elastane, carbon
Coating	palm and fingertips with NBR foam coating
Suitable for	dry and slightly damp areas
Colour	blue, anthracite
Sizes	6 to 11
Order quantity multiples	10 PR

uvex athletic lite dry

- lightweight and sensitive safety glove for mechanical tasks
- matt, porous and particularly abrasion-resistant microfoam coating
- with nubbing, for increased durability and a good grip
- sehr gute Griffsicherheit in trockenen und very good grip in dry and slightly damp areas
- high breathability thanks to the porous coating, reducing sweating
- perfect fit thanks to the “slim fit” design and elastane in the liner
- certified according to OEKO-TEX® Standard 100 (S02-0648 HOHENSTEIN HTTI)

	uvex athletic lite dry
Art. no.	60033
Design	knitted cuff
Standard	EN 388 (4 1 3 1 X), EN 407 (X 1 X X X X)
Material	polyamide, elastane
Coating	palm and fingertips with NBR foam coating, dots
Suitable for	dry and slightly damp areas
Colour	blue, anthracite
Sizes	6 to 12
Order quantity multiples	10 PR



Mechanical Risks

Area of application: precision/all-round



60573



60585



60321



uvex unilite 6605

- lightweight knitted glove with NBR foam coating for mechanical precision work
- good mechanical abrasion resistance with the polyamide liner and coating
- good grip in dry and slightly damp areas
- breathable
- good tactile feel
- good fit
- highly flexible

uvex unilite 7700

- flexible and durable safety glove for mechanical precision work
- good mechanical abrasion resistance with the polyamide-elastane liner and NBR polyurethane coating
- good grip in dry and slightly damp to slightly oily areas
- good tactile feel
- very good fit
- highly flexible

uvex unipur 6634

- moisture-proof NBR safety glove for mechanical applications outdoors
- very good abrasion resistance with the polyamide liner and NBR coating
- good grip in damp areas
- good tactile feel
- good fit
- highly flexible



Art. no.	uvex unilite 6605 60573
Design	knitted cuff
Standard	EN 388 (4 1 2 2 X)
Material	polyamide
Coating	palm and fingertips coated with nitrile foam coating
Suitable for	dry and slightly damp areas
Colour	black, black
Sizes	6 to 11
Order quantity multiples	10 PR

Art. no.	uvex unilite 7700 60585
Design	knitted cuff
Standard	EN 388 (4 1 2 1 X)
Material	polyamide, elastane
Coating	palm and fingertips coated with NBR/polyurethane coating
Suitable for	dry and damp, oily working conditions
Colour	grey, black
Sizes	7 to 11
Order quantity multiples	10 PR

Art. no.	uvex unipur 6634 60321
Design	knitted cuff
Standard	EN 388 (4 1 3 1 X)
Material	polyamide
Coating	palm and fingertips coated with NBR coating
Suitable for	damp, oily or greasy areas of application
Colour	grey, black
Sizes	7 to 10
Order quantity multiples	10 PR



Mechanical Risks

Area of application: precision/all-round



60943



60944



60248



uvex unipur 6630 · uvex unipur 6631

- light and very sensitive PU safety glove for mechanical precision work
- good mechanical abrasion resistance
- good grip in dry and slightly damp areas
- outstanding tactile feel
- very good fit
- highly flexible

uvex unipur 6639

- lightweight, high dexterity and dirt-resistant PU safety glove for mechanical precision work
- good mechanical abrasion resistance
- good grip in dry and slightly damp areas
- outstanding tactile feel
- very good fit
- highly flexible

	uvex unipur 6630	uvex unipur 6631
Art. no.	60943	60944
Design	knitted cuff	knitted cuff
Standard	EN 388 (4 1 4 1 X)	EN 388 (4 1 4 1 X)
Material	polyamide	polyamide
Coating	palm and fingertips coated with polyurethane coating	palm and fingertips coated with polyurethane coating
Suitable for	dry and slightly damp areas	dry and slightly damp areas
Colour	white, white	grey, grey
Sizes	6 to 11	6 to 11
Order quantity multiples	10 PR	10 PR

	uvex unipur 6639
Art. no.	60248
Design	knitted cuff
Standard	EN 388 (4 1 3 1 X)
Material	polyamide
Coating	palm and fingertips coated with polyurethane coating
Suitable for	dry and slightly damp areas
Colour	black, black
Sizes	6 to 11
Order quantity multiples	10 PR



Mechanical Risks

Area of application: precision/all-round



60556

Variant with microdots on palm

60587

Variant without microdots on palm

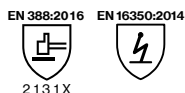
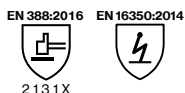

60238

60135



MADE IN GERMANY

uvex unipur carbon

- sensitive and anti-static safety glove for precision work with electronic parts
- very good grip
- fulfils requirement of DIN EN 16350:2014
- very high level of breathability
- outstanding tactile feel
- Art.No. 60556: Made in Germany

uvex unigrip

- knitted safety gloves with 13-gauge (uvex unigrip PA and uvex unigrip 6620) for precise mechanical work and 10 gauge (uvex unigrip 6624) for rougher mechanical activities
- good grip with the thin PVC dots in dry areas



	uvex unipur carbon	uvex unipur carbon FT
Art. no.	60556	60587
Design	knitted cuff	knitted cuff
Standard	EN 388 (2 1 3 1 X) EN 16350	EN 388 (2 1 3 1 X) EN 16350
Material	polyamide, carbon	polyamide, carbon
Coating	palm with carbon microdots, fingertips with thin elastomer coating	fingertips with thin elastomer coating
Suitable for	dry areas of application	dry areas of application
Colour	grey, black, white	grey, white
Sizes	6 to 10	6 to 10
Order quantity multiples	10 PR	10 PR

	uvex unigrip 6624	uvex unigrip 6620
Art. no.	60238	60135
Design	knitted cuff, 10-gauge	knitted cuff, 13-gauge
Standard	EN 388 (2 2 4 2 B)	EN 388 (2 2 4 1 B)
Material	polyamide, cotton	polyamide, cotton
Coating	palm and fingers coated with PVC dots	palm and fingers coated with PVC dots
Suitable for	dry areas of application	dry areas of application
Colour	grey, red	white, blue
Sizes	7 to 10	7 to 10
Order quantity multiples	10 PR	10 PR



Mechanical Risks

Area of application: all-round/heavy duty



60150



60147



60148



MADE IN GERMANY

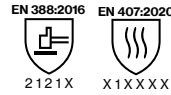

MADE IN GERMANY

uvex contact ergo

- thick, hard-wearing cotton interlock safety glove with NBR coating
- very good grip in damp, wet and oily areas
- good tactile feel
- ergonomic fit
- highly flexible
- good wearer comfort with high water vapour absorption of the cotton lining
- certified according to OEKO-TEX® Standard 100 (S02-0648 HOHENSTEIN HTTI)

uvex profi ergo

- cotton interlock safety glove with NBR coating for universal use
- very good grip in damp, wet and oily areas
- good tactile feel
- ergonomic fit
- high flexibility
- very good wearer comfort due to the high water vapour absorption of the cotton lining
- certified according to OEKO-TEX® Standard 100 (S02-0648 HOHENSTEIN HTTI)

	uvex contact ergo ENB20C
Art. no.	60150
Design	knitted cuff
Standard	EN 388 (2 1 2 1 X)
Material	cotton interlock
Coating	palm and fingers with special NBR coating (nitrile rubber)
Suitable for	oily and greasy areas of application
Colour	white, orange
Sizes	6 to 10
Order quantity multiples	10 PR

	uvex profi ergo ENB20A	uvex profi ergo ENB20
Art. no.	60147	60148
Design	knitted cuff	knitted cuff
Standard	EN 388 (2 1 2 1 X), EN 407 (X 1 X X X X)	EN 388 (2 1 2 1 X), EN 407 (X 1 X X X X)
Material	cotton interlock	cotton interlock
Coating	palm and 3/4 of the back of the hand with special NBR coating (nitrile rubber)	palm and whole back of the hand with special NBR coating (nitrile rubber)
Suitable for	damp, oily or greasy areas of application	damp, oily or greasy areas of application
Colour	white, orange	white, orange
Sizes	6 to 11	6 to 10
Order quantity multiples	10 PR	10 PR



Mechanical Risks

Area of application: all-round/heavy duty

Exceptional grip



60558

Exceptional grip



60208



6047900

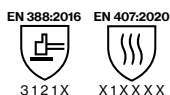

uvex profi ergo XG

- safety glove with uvex Xtra Grip Technology
- very good mechanical abrasion resistance thanks to the multi-layer design for increased service life
- outstanding grip in damp, wet and oily areas
- good tactile feel
- ergonomic fit
- highly flexible
- very good wearer comfort with high water vapour absorption of the cotton lining
- certified according to OEKO-TEX® Standard 100 (S02-0648 HOHENSTEIN HTTI)

uvex glove clip

- universal fastening options due to snap hooks
- easy handling
- suitable for all gloves
- gloves are quickly fixed and released
- perfect hold due to jagged clamps
- uncomplicated attachment to work clothing



	uvex profi ergo XG20A	uvex profi ergo XG20
Art. no.	60558	60208
Design	knitted cuff	knitted cuff
Standard	EN 388 (3 1 2 1 X), EN 407 (X 1 X X X X X)	EN 388 (3 1 2 1 X), EN 407 (X 1 X X X X X)
Material	cotton interlock	cotton interlock
Coating	palm and 3/4 of the back of the hand with special NBR coating and Xtra Grip coating (nitrile rubber)	palm and whole back of the hand with special NBR and Xtra Grip coating (nitrile rubber)
Suitable for	damp, oily or greasy areas of application	damp, oily or greasy areas of application
Colour	white, orange, black	white, orange, black
Sizes	6 to 11	6 to 11
Order quantity multiples	10 PR	10 PR

	uvex glove clip
Art. no.	6047900
Design	glove keeper with snap hook
Material	Polycarbonate
Coating	without
Suitable for	easy access to gloves
Colour	black
Order quantity multiples	10 PC



Mechanical Risks

Area of application: Heavy duty



89636



60278



60946

60945

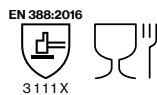

MADE IN GERMANY

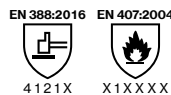

uvex rubiflex

- fully coated cotton interlock safety glove for mechanical activities
- very good mechanical abrasion resistance with NBR coating
- good tactile feel
- ergonomic fit
- certified according to OEKO-TEX® Standard 100 (S02-0648 HOHENSTEIN HTTI)

Art. no.	uvex rubiflex NB27 89636
Design	gauntlet, approx. 27 cm
Standard	EN 388 (3 111 X)
Material	cotton interlock
Coating	fully coated with special NBR coating (nitrile rubber)
Suitable for	damp, oily or greasy areas of application
Colour	orange
Sizes	7 to 11
Order quantity multiples	10 PR

uvex unilite 7710 F

- waterproof assembly glove with grip
- excellent grip in wet and oily areas
- extremely abrasion-resistant for heavy-duty activities
- protection against contact heat to 100°C (level 1)
- highly flexible, seamless polyester-knit liner

Art. no.	uvex-unilite 7710F 60278
Design	knitted cuff
Standard	EN 388 (4 1 2 1 X), EN 407 (X 1 X X X X)
Material	polyester (seamless)
Coating	palm and whole back of the hand with NBR (nitrile rubber) with grip finish
Suitable for	excellent grip in wet and oily areas
Colour	blue, black
Sizes	7 to 11
Order quantity multiples	10 PR

uvex compact

- very durable NBR safety glove for rough work and manual tasks involving raw materials
- very good mechanical abrasion resistance with NBR coating

Art. no.	uvex compact NB27E 60946	uvex compact NB27H 60945
Design	canvas gauntlet	canvas gauntlet
Standard	EN 388 (4 1 2 1 B)	EN 388 (4 1 2 1 B)
Material	jersey cotton	jersey cotton
Coating	palm and 3/4 of the back of the hand with NBR coating (nitrile rubber)	palm and whole back of the hand with NBR coating (nitrile rubber)
Suitable for	damp, oily or greasy areas of application	damp, oily or greasy areas of application
Colour	white, blue	white, blue
Sizes	9 to 10	10
Order quantity multiples	10 PR	10 PR



Mechanical Risks

Area of application: Heat risks



60213



60179



60595

Sandwich lining

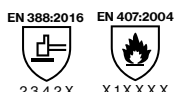

2 3 4 2 X X 1 X X X X

MADE IN GERMANY

Cotton cladding

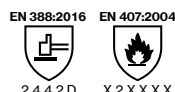

2 4 4 2 D X 2 X X X X

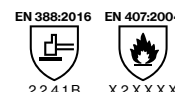

2 2 4 1 B X 2 X X X X

uvex nk

- safety glove for thermal applications
- good mechanical abrasion resistance
- very good grip in dry, damp and oily areas through the rough surface
- very good thermal insulation in direct contact with warm to hot objects
- suitable for contact heat up to +100 °C (as per EN 407)
- certified according to OEKO-TEX® Standard 100 (S02-0648 HOHENSTEIN HTTI)

	uvex NK2722	uvex NK4022
Art. no.	60213	60202
Design	gauntlet, approx. 27 cm	gauntlet, approx. 40 cm
Standard	EN 388 (2 3 4 2 X), EN 407 (X 1 X X X X X)	EN 388 (2 3 4 2 X), EN 407 (X 1 X X X X X)
Material	cotton interlock, aramid knit	
Coating	fully coated with special NBR coating (nitrile rubber)	
Suitable for	damp, oily or greasy areas of application	
Colour	orange	
Sizes	9 to 10	9 to 10
Order quantity multiples	10 PR	10 PR

uvex k-basic extra

- Kevlar® coarse-knitted glove for mechanical and thermal activities
- very good thermal insulation in direct contact with warm to hot objects
- suitable for contact heat up to +250 °C
- good cut protection
- good wearer comfort with cotton lining on the inside
- breathable

	uvex k-basic extra 6658
Art. no.	60179
Design	knitted cuff, 7-gauge
Standard	EN 388 (2 4 4 2 D), EN 407 (X 2 X X X X X)
Material	100 % Kevlar®, cotton lining (inside)
Coating	none
Suitable for	cut and heat-resistant
Colour	yellow
Sizes	8, 10, 12
Order quantity multiples	5 PR

uvex profatherm

- cotton terry safety glove for thermal applications
- very good thermal insulation in direct contact with warm to hot objects
- suitable for contact heat up to +250 °C
- good wearer comfort with the cotton terry material on the inside

	uvex profatherm XB40
Art. no.	60595
Design	gauntlet, approx. 40 cm
Standard	EN 388 (2 2 4 1 B), EN 407 (X 2 X X X X X)
Material	cotton terry
Coating	none
Suitable for	insulation against heat and cold
Colour	white
Sizes	11
Order quantity multiples	6 PR



Mechanical Risks

Area of application: Cold protection

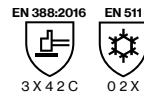
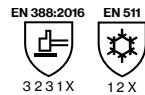
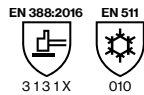
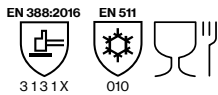

uvex unilite thermo

- winter glove with dual-layer design
- good mechanical abrasion resistance with a polymer coating that is flexible at low temperatures
- very good thermal insulation in direct contact with cold objects
- good fit

	uvex unilite thermo	uvex unilite thermo plus	uvex unilite thermo HD
Art. no.	60593	60592	60942
Design	knitted cuff	knitted cuff	knitted cuff
Standard	EN 388 (3131X), EN 511 (010)	EN 388 (3131X), EN 511 (010)	EN 388 (3231X), EN 511 (12X)
Material	acrylic and new wool mix (lining), polyamide and elastane (outer)	acrylic and new wool mix (lining), polyamide and elastane (outer)	cotton terry material and acrylic (lining), nylon (outer)
Coating	palm and fingertips with cold-flexible polymer coating	palm and 3/4 of the back of the hand with cold-flexible polymer coating	palm and whole back of the hand with PVC coating, 3/4 grip coating
Suitable for	dry and slightly damp working conditions	dry and slightly damp working conditions	damp, oily working conditions
Colour	black, black	black, black	red, black
Sizes	7 to 11	7 to 11	8 to 11
Order quantity multiples	10 PR	10 PR	10 PR

uvex unilite thermo plus cut c

- outstanding tactile feel
- high abrasion resistance
- flexible at cold temperatures
- mechanical resistance
- very high cut protection (Level C)

	uvex unilite thermo plus cut c
Art. no.	60591
Design	back of the hand partially coated, knitted cuff
Standard	EN 388 (3X42C), EN 511 (02 X)
Material	two-layer design: acrylic (inside), glass/polyamide (outside)
Coating	palm and fingertips with polymer coating that is flexible in the cold
Suitable for	dry and slightly damp working conditions
Colour	lime, black
Sizes	7 to 11
Order quantity multiples	10 PR



Mechanical Risks

Area of application: Working on live parts



60840



60838

EN 60903:2003



Class 0/RC

EN 61482-1-2



Class 1

EN 388:2016



1 X 2 1 X

EN 407:2004



4 1 1 1 X X

EN 61482-1-2



Class 1

MADE IN GERMANY

uvex power protect V1000

- protection against electrical voltages up to 1000V
- due to the anatomical shape the glove offers high dexterity
- high flexibility of the material offers high wearer comfort, even at low temperatures
- arc flash protection class 1 EN 61482-1-2 (box test)

	uvex power protect V1000
Art. no.	60840
Design	41 cm straight cuff
Standard	EN 60903 (Class 0/RC), EN 61482-1-2 (Class 1)
Material	no lining
Coating	natural latex, 1,6 mm
Suitable for	good resistance to oils, acids and ozone
Colour	red
Sizes	7 to 11
Order unit	PR

uvex arc protect g1



































- ergonomic fit
- good wearer comfort
- exceptional dexterity right to the fingertips
- very good protection against thermal discharge
- arc flash protection class 1 EN 61482-1-2 (box test)
- thermal protection
- certified according to OEKO-TEX® Standard 100 (S02-0648 HOHENSTEIN HTTI)

	uvex arc protect g1
Art. no.	60838
Design	27 cm cuff
Standard	388:2016 (1 X 2 1 X), 407 (4 1 1 1 X X), 61482-1-2 (Class 1)
Material	modacryl, cotton, antistatic
Coating	none
Suitable for	for dry areas of application
Colour	anthracite
Sizes	7 to 11
Order quantity multiples	10 PR



Mechanical Risks

Cut protection at a glance

ISO Level 13997	 Precision	 All-round	 Heavy duty	
D	 uvex Bamboo TwinFlex D xg	 uvex athletic D5 XP	 uvex D500 foam	
				
				
C	 uvex C500	 uvex C500 dry	 uvex C300 dry	
	 uvex phynomic airLite C ESD	 uvex phynomic C5	 uvex athletic C XP	
	 uvex C300 foam	 uvex C500 foam	 uvex unidur 6659 foam	
		 uvex C300 wet	 uvex C500 wet	
			 uvex C500 wet plus	
			 uvex C500 XG	
B	 uvex phynomic airLite B ESD	 uvex phynomic C3	 uvex athletic B XP	
	 uvex unidur 6641	 uvex unidur 6648	 uvex unidur 6649	
			 uvex unidur 6643	

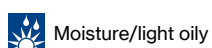

For safety gloves with cut protection level E and above, uvex recommends products from HexArmor®.

Bamboo TwinFlex® technology

High-tech for greater comfort when wearing the cut protection glove



Silky-soft feel and high moisture absorption thanks to bamboo fibre

uvex cut protection gloves based on the latest generation of patented uvex Bamboo TwinFlex® technology set new standards in protection, comfort, flexibility, dexterity and economy. The tailor-made cut-protection comfort class helps increase wearer acceptance – particularly when carrying out demanding activities – as the unique combination

of silky-soft bamboo fibre and high-tech protective fibres ensures a high level of wearer comfort and good climate characteristics while also providing effective protection. After all, a safety glove can only help to prevent accidents if the user actually wears it.

Technology

Patented Bamboo TwinFlex® protection

Cut-resistant glass fibres and abrasion-resistant polyamide guarantee optimum mechanical protection. The use of steel fibres in combination with HPPE and polyamide increases the cut protection even to level D.

Patented Bamboo TwinFlex® comfort

Silky-soft, comfortable material on the inside of the bamboo-viscose glove ensures very high wearer comfort against the skin. The bamboo fibre not only feels incredibly good on the skin, it also has a very high and quick moisture absorption to keep your skin comfortable and dry while working.

Bamboo TwinFlex® Technology ¹			
Cut protection level C		Cut protection level D	
Double Face Principle			
Polyamide (abrasion resistance)	Bamboo (wearer comfort)	Polyamide (abrasion resistance)	Bamboo (wearer comfort)
Glass fibres (cut protection)	High-grade HPPE fibres (tear resistance)	Steel fibres (cut protection)	High-grade HPPE fibres (tear resistance)
e.g. uvex C500 M, uvex C500 und uvex C300		e.g. uvex Bamboo TwinFlex D xg, uvex D500 foam	



Bamboo TwinFlex® technology

High-tech for greater comfort when wearing the cut protection glove

First-class climate control

uvex climazone – measurably enhanced comfort

- reduced sweating
- high breathability
- significantly greater moisture absorption compared to other types of fibres

Wearer comfort and an improved microclimate are the ultimate benchmarks in safety gloves. This is why the uvex climazone climate-management system in hand protection is being continuously developed together with market-leading partners and renowned testing and research institutes.

NEW
uvex
protexxion zone



clima zone

Noticeably superior in

- 1 Comfort
- 2 Health
- 3 Cost-effectiveness (long-lasting)
- 4 Protection, touchscreen
- 5 Quality, sustainability

45%

sustainable materials:

- bamboo comfort fibre
- Polyamide-Recyclate



Bamboo TwinFlex® D xg

The latest generation of cut protection gloves – Cut Level D



Comfortable: Silky-soft bamboo fibre



Healthy: tested for skin compatibility



Long-lasting: uvex protexxion zone



Additional feature: Can be used with touchscreens



Local: Made in Germany

XG Xtra Grip
clima zone

60090

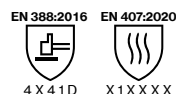

MADE IN GERMANY

uvex Bamboo TwinFlex® D xg

- the patented Bamboo TwinFlex yarn technology ensures fast absorption and high retention of moisture as well as a silky-soft feel against the skin
- uses sustainable raw materials: Bamboo fibre, recycled polyamide
- high level of sensitivity
- adaptive fit: adapts precisely to fit the shape of the hand within a few minutes of wearing
- particularly light, thin and flexible with high cut protection due to the use of the finest steel (Cut Level D)
- touchscreen capability means there is no need to remove the glove
- heat protection: Protection against contact heat up to 100°C
- long service life thanks to uvex protexxion zone and premium Xtra-Grip coating
- uvex protexxion zone with smooth material surface ensures that work processes run smoothly
- dermatologically tested, free from allergenic accelerators
- certified according to OEKO-TEX® Standard 100 (S02-0648 HOHENSTEIN HTTI)



	uvex Bamboo TwinFlex® D xg
Art. no.	60090
Design	knitted cuff
Standard	EN 388 (4X41D), EN 407 (X1XXXX)
Material	bamboo viscose, HPPE, steel, polyamide, elastane
Coating	aqua-polymer xtra grip foam coating
Suitable for	dry and damp, oily areas
Colour	green, black
Sizes	6 to 12
Order quantity multiples	10 PR



Mechanical Risks

Area of application: cut protection



60604



MADE IN GERMANY



Crouch zone reinforcement



60498

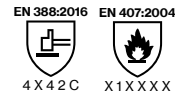

MADE IN GERMANY

uvex D500 foam

- cut protection gloves with excellent wearer comfort, well suited for all-round activities
- high abrasion resistance thanks to the innovative Soft-Grip-Coating
- very good grip in slightly damp environments
- very high uvex cut protection with Bamboo Twin Flex® technology
- high flexibility
- very good tactile feel
- perfect fit with 3D Ergo man mold technology
- certified according to OEKO-TEX® Standard 100 (S02-0648 HOHENSTEIN HTTI)

	uvex D500 foam
Art. no.	60604
Design	knitted cuff
Standard	EN 388 (4 X 4 2 D)
Material	bamboo-rayon, Dyneema® Diamond, steel, polyamide
Coating	palm and fingertips with high-performance elastomer (HPE) and SoftGrip foam coating
Suitable for	dry areas and slightly damp areas
Colour	lime, anthracite
Sizes	7 to 11
Order quantity multiples	10 PR

uvex C500 M foam

- cut protection gloves with excellent wearer comfort, well suited for all-round activities
- outstanding mechanical abrasion resistance thanks to the innovative SoftGrip coating
- very good grip in dry and slightly damp environments
- very high level of cut protection with patented Bamboo TwinFlex® technology
- suitable for contact heat up to +100 °C, in line with EN 407
- partially reinforced thumb joints
- very good tactile feel, high level of flexibility
- perfect fit with 3D Ergo man mould technology
- silicone-free according to imprint test
- certified according to OEKO-TEX® Standard 100 (S02-0648 HOHENSTEIN HTTI)

	uvex C500 M foam
Art. no.	60498
Design	crouch zone reinforcement, knitted cuff
Standard	EN 388 (4 X 4 2 C), EN 407 (X 1 X X X X)
Material	bamboo-rayon, HPPE, glass, polyamide
Coating	High Performance Elastomer (HPE), SoftGrip foam
Suitable for	for dry and slightly oily/damp areas
Colour	lime, black, anthracite
Sizes	7 to 11
Order quantity multiples	10 PR



Mechanical Risks

Area of application: cut protection



60491

60497

60496

60600

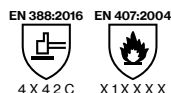

MADE IN GERMANY

uvex C500

- cut protection glove or forearm protection (uvex C500 sleeve) with excellent wearer comfort, well suited for all-round activities
- outstanding mechanical abrasion resistance thanks to the innovative Soft Grip coating (uvex C500 wet plus and uvex C500 XG)
- very good grip in dry (all models), slightly damp/wet (uvex C500 wet plus) and oily (uvex C500 XG) environments
- very high level of cut protection with patented uvex Bamboo TwinFlex® technology

- highly flexible
- very good tactile feel
- perfect fit with 3D Ergo technology
- silicone-free according to imprint test
- certified according to OEKO-TEX® Standard 100 (S02-0648 HOHENSTEIN HTTI)



	uvex C500 sleeve	uvex C500	uvex C500 wet plus	uvex C500 XG
Art. no.	60491-07 60491-10	60497	60496	60600
Design	underarm protection with velcro fastening, 34 cm (M), 40 cm (L)	knitted cuff	knitted cuff	knitted cuff
Standard	EN 388 (2 X 4 X C)	EN 388 (1 X 4 X C)	EN 388 (4 X 4 2 C), EN 407 (X 1 X X X X)	EN 388 (4 X 4 2 C)
Material	bamboo rayon, HPPE, glass, polyamide	bamboo rayon, HPPE, glass, polyamide	bamboo rayon, HPPE, glass, polyamide	bamboo rayon, HPPE, glass, polyamide
Coating	none	none	palm and 3/4 of the back of the hand with high performance elastomer (HPE) coating	palm and whole back of the hand with high performance elastomer (HPE) and Xtra Grip coating
Suitable for	dry areas of application	dry areas of application	damp, oily or greasy areas of application	damp, wet, oily or greasy areas of application
Colour	lime	lime	lime, anthracite	lime, anthracite
Sizes	M L	7 to 11	7 to 11	7 to 11
Order quantity multiples/	PC PC	10 PR	10 PR	10 PR
Order unit				



Mechanical Risks

Area of application: cut protection



60499



60494



60492

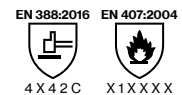
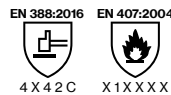

MADE IN GERMANY

uvex C500

- cut protection safety gloves with outstanding wearer comfort
- outstanding mechanical abrasion resistance thanks to the innovative SoftGrip coating (uvex C500 foam and uvex C500 wet)
- very good grip in dry (all models), slightly damp (uvex C500 foam) and wet (uvex C500 wet) environments
- very high level of cut protection with patented uvex Bamboo TwinFlex® technology
- in line with EN 407, the model is suitable for contact heat up to +100°C (uvex C500 foam and C500 sleeve)
- highly flexible
- very good tactile feel
- perfect fit with 3D Ergo technology
- silicone-free according to imprint test
- certified according to OEKO-TEX® Standard 100 (S02-0648 HOHENSTEIN HTTI)

	uvex C500 dry	uvex C500 foam	uvex C500 wet
Art. no.	60499	60494	60492
Design	knitted cuff	knitted cuff	knitted cuff
Standard	EN 388 (X X 4 X C)	EN 388 (4 X 4 2 C), EN 407 (X 1 X X X X)	EN 388 (4 X 4 2 C), EN 407 (X 1 X X X X)
Material	bamboo rayon, HPPE, glass, polyamide	bamboo rayon, HPPE, glass, polyamide	bamboo rayon, HPPE, glass, polyamide
Coating	palm and fingers with high performance vinyl (HPV) grip dots	palm and fingertips with high performance elastomer (HPE) and Soft Grip foam coating	palm and fingertips with high performance elastomer (HPE) coating
Suitable for	dry areas of application	dry areas of application	damp, oily or greasy areas of application
Colour	lime, anthracite	lime, anthracite	lime, anthracite
Sizes	7 to 11	7 to 11	7 to 11
Order quantity multiples	10 PR	10 PR	10 PR



Mechanical Risks

Area of application: cut protection



60549



60544



60542

EN 388:2016



X X 4 X C

EN 388:2016



3 X 4 2 C

EN 388:2016



4 X 4 2 C



MADE IN GERMANY



uvex C300

- cut protection glove with excellent wearer comfort
- outstanding mechanical abrasion resistance thanks to the innovative SoftGrip coating (uvex C300 foam and uvex C300 wet)
- very good grip in dry (all models), slightly damp (uvex C300 foam) and wet (uvex C300 wet) environments

- good cut protection with patented uvex Bamboo TwinFlex® technology
- highly flexible
- very good tactile feel
- perfect fit with 3D Ergo technology
- silicone-free according to imprint test
- certified according to OEKO-TEX® Standard 100 (S02-0648 HOHENSTEIN HTTI)

	uvex C300 dry	uvex C300 foam	uvex C300 wet
Art. no.	60549	60544	60542
Design	knitted cuff	knitted cuff	knitted cuff
Standard	EN 388 (X X 4 X C)	EN 388 (3 X 4 2 C)	EN 388 (4 X 4 2 C)
Material	bamboo rayon, HPPE, glass, polyamide	bamboo rayon, HPPE, glass, polyamide	bamboo rayon, HPPE, glass, polyamide
Coating	palm and fingers with high performance vinyl (HPV) grip dots	palm and fingertips with high performance elastomer (HPE) and Soft Grip foam coating	palm and fingertips with high performance elastomer (HPE) coating
Suitable for	dry areas of application	dry areas of application	damp, oily or greasy areas of application
Colour	anthracite	anthracite	anthracite
Sizes	7 to 11	7 to 11	7 to 11
Order quantity multiples	10 PR	10 PR	10 PR



uvex phynomic Perfection in 3 dimensions

1. Perfect fit
2. Optimal function
3. Absolute purity

uvex phynomic gloves are characterised by their ergonomic fit, which is perfectly matched to the intended use, and above all by their outstanding health protection. They are free from allergenic accelerators and harmful solvents, and their skin compatibility has been dermatologically approved through user testing by proDERM-Institut®. (see also pg. 199)

Additional functions such as touchscreen and ESD compatibility or suitability for the food industry enable use in specialist application areas



60078



MADE IN GERMANY



uvex phynomic airLite B ESD

- the lightest and most sensitive cut protection glove in Cut Level B
- ESD function (DIN EN 16350:2014)
- noticeable difference in wearer comfort: combination of the highest sensitivity, lightness and high breathability
- touchscreen compatibility for use on almost all screens, tablets and mobile phones
- thin, breathable "airLite" aqua-polymer coating in combination with a high-quality liner (18 gauge) offers the highest sensitivity and tactile feel for precision work
- very good grip in dry and slightly damp areas
- free from glass and steel fibres
- certified according to OEKO-TEX® Standard 100 (S02-0648 HOHENSTEIN HTTI)

Art. no.	uvex phynomic airLite B ESD 60078
Design	knitted cuff
Standard	EN 388 (3 X 3 2 B), EN 16350
Material	Dyneema® Diamond Technology, polyamide, elastane, carbon
Coating	aqua-polymer coating airLite on palm and fingertips
Suitable for	dry areas and slightly damp areas
Colour	sky blue, black
Sizes	6 to 12
Order quantity multiples	10 PR



Mechanical Risks

Area of application: cut protection



60084

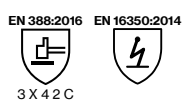

MADE IN GERMANY



60080

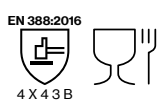

MADE IN GERMANY



60081

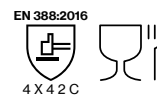

MADE IN GERMANY



uvex phynomic airLite C ESD

- the lightest and most sensitive cut protection glove in Cut Level C
- ESD function (DIN EN 16350:2014)
- noticeably thin and sensitive in combination with high cut protection (Level C) thanks to innovative cut protection fibres: Dyneema® Diamond 2.0
- free from glass and steel fibres
- touchscreen compatibility for use on almost all screens, tablets and mobile phones
- thin, breathable "airLite" aqua-polymer coating in combination with a high-quality liner (18 gauge) offers the highest sensitivity and tactile feel for precision work
- very good grip in dry and slightly damp areas
- certified according to OEKO-TEX® Standard 100 (S02-0648 HOHENSTEIN HTTI)

uvex phynomic C3

- sensitive cut protection safety glove for mechanical activities
- suitable for use in the food industry
- very good mechanical abrasion resistance thanks to the damp-resistant aqua-polymer foam coating
- good grip in dry and slightly damp areas
- good cut protection and high tear resistance
- highly breathable coating
- outstanding tactile feel when assembling parts
- certified according to OEKO-TEX® Standard 100 (S02-0648 HOHENSTEIN HTTI)

uvex phynomic C5

- all-round cut protection safety glove for mechanical activities
- suitable for use in the food industry
- very good mechanical abrasion resistance thanks to the moisture-resistant aqua-polymer foam coating
- very good grip in dry and slightly damp areas
- very good cut protection (level C) and high tear resistance
- highly breathable coating
- outstanding tactile feel when assembling parts
- sustainable: with 45% bio-based HPPE (DSM Dyneema)
- certified according to OEKO-TEX® Standard 100 (S02-0648 HOHENSTEIN HTTI)



Art. no.	uvex phynomic airLite C ESD 60084
Design	knitted cuff
Standard	EN 388 (3 X 4 2 C), EN 16350
Material	Dyneema® Diamond 2.0 Technology, polyamide, elastane, carbon
Coating	palm and fingertips with aqua-polymer coating airLite
Suitable for	dry areas and slightly damp areas
Colour	blue, black
Sizes	6 to 12
Order quantity multiples	10 PR



Art. no.	uvex phynomic C3 60080
Design	knitted cuff
Standard	EN 388 (4 X 4 3 B)
Material	polyamide, elastane, HPPE, glass
Coating	aqua-polymer foam coating on palm and fingertips
Suitable for	dry areas and slightly damp areas
Colour	sky blue, grey
Sizes	6 to 12
Order quantity multiples	10 PR



Art. no.	uvex phynomic C5 60081
Design	knitted cuff
Standard	EN 388 (4 X 4 2 C)
Material	Dyneema® Diamond Technology (bio-based), polyamide, elastane
Coating	palm and fingertips with aqua-polymer foam coating
Suitable for	dry areas and slightly damp areas
Colour	blue, grey
Sizes	6 to 12
Order quantity multiples	10 PR



Mechanical Risks

Area of application: cut protection



Crouch zone reinforcement ▶

60036



Crouch zone reinforcement ▶

60037



uvex athletic B XP

- very high cut protection (Level B)
- good grip on dry and (slightly)
- oily/wet workpieces
- very good mechanical abrasion resistance
- reinforced thumb joints
- high flexibility, very good fit
- very good tactile feel
- suitable for industrial washing
- certified according to OEKO-TEX® Standard 100 (S02-0648 HOHENSTEIN HTTI)

Art. no.	uvex athletic B XP 60036
Design	knitted cuff
Standard	EN 388 (4 X 4 4 B)
Material	HPPE, glas, polyamide, elastane
Coating	palm and fingertips coated, micro NBR foam coating
Suitable for	dry and slightly damp/oily working conditions
Colour	grey, anthracite
Sizes	6 to 12
Order quantity multiples	10 PR

uvex athletic C XP

- very high cut protection (Level C)
- good grip on dry and (slightly)
- oily/wet workpieces
- very good mechanical abrasion resistance
- reinforced thumb joints
- high flexibility, very good fit
- very good tactile feel
- suitable for industrial washing
- certified according to OEKO-TEX® Standard 100 (S02-0648 HOHENSTEIN HTTI)

Art. no.	uvex athletic C XP 60037
Design	knitted cuff
Standard	EN 388 (4 X 4 3 C)
Material	HPPE, glas, polyamide, elastane
Coating	palm and fingertips coated, micro NBR foam coating
Suitable for	dry and slightly damp/oily working conditions
Colour	grey, anthracite
Sizes	6 to 12
Order quantity multiples	10 PR



Mechanical Risks

Area of application: cut protection



Crouch zone reinforcement ▶

60030



60974

60973



uvex athletic D5 XP

- very high cut protection (Level D)
- good grip on dry and (slightly) oily/wet workpieces
- very good mechanical abrasion resistance
- reinforced thumb joints
- high flexibility, very good fit
- very good tactile feel
- suitable for industrial washing
- certified according to OEKO-TEX® Standard 100 (S02-0648 HOHENSTEIN HTTI)

Art. no.	uvex athletic D5 XP
Design	60030 knitted cuff
Standard	EN 388 (4 X 4 3 D)
Material	HPPE, steel, polyamide, elastane
Coating	palm and fingertips coated, micro NBR foam coating
Suitable for	dry and slightly damp/oily working conditions
Colour	grey, anthracite
Sizes	6 to 11
Order quantity multiples	10 PR

uvex unidur sleeve C · uvex unidur sleeve C TL

- very high cut protection (Cut Level C)
- very thin and flexible
- high comfort
- velcro fastening for a custom fit
- 60974: thumb loop (TL) for added safety (protection against cuts on the wrist)
- certified according to OEKO-TEX® Standard 100 (S02-0648 HOHENSTEIN HTTI)

Art. no.	uvex unidur sleeve C	uvex unidur sleeve C TL
Design	60973 Lower arm protection with velcro fastening	60974 Lower arm protection with velcro fastening with thumb loop
Standard	46 cm (size M), 50 cm (size L) EN 388 (2 X 4 X C)	
Material	HPPE, glass, polyamide	
Coating	without coating	
Suitable for	for dry areas	
Colour	mottled grey	mottled grey
Sizes	M, L	M, L
Order unit	PC	PC



Mechanical Risks

Area of application: cut protection



60210



60932



60516



uvex unidur 6641

- PU cut protection safety glove with high-quality Special Cut Performance PE fibre
- outstanding mechanical abrasion resistance thanks to a good combination of fibres and coating
- good grip in dry and slightly damp areas
- good cut protection due to high-quality Special Cut Performance PE fibre
- very good tactile feel
- highly flexible
- outstanding comfort

uvex unidur 6648 · uvex unidur 6649

- PU cut protection glove with HPPE fibres
- outstanding mechanical abrasion resistance
- good grip in damp and oily areas
- good cut protection with HPPE fibres
- good tactile feel
- highly flexible
- good wearer comfort

Art. no.	uvex unidur 6641 60210
Design	knitted cuff
Standard	EN 388 (4 3 4 3 B)
Material	HPPE, elastane
Coating	palm and fingertips with polyurethane coating
Suitable for	dry areas and slightly damp areas
Colour	white, grey
Sizes	6 to 11
Order quantity multiples	10 PR

Art. no.	uvex unidur 6648 60932	uvex unidur 6649 60516
Design	knitted cuff	knitted cuff
Standard	EN 388 (4 3 4 2 B)	
Material	HPPE, elastane	HPPE, polyamide, elastane
Coating	palm and fingertips with polyurethane coating	
Suitable for	dry areas and slightly damp areas	
Colour	white, black	mottled blue, grey
Sizes	6 to 11	7 to 11
Order quantity multiples	10 PR	10 PR



Mechanical Risks

Area of application: cut protection



60314



60938



uvex unidur 6643

- NBR cut protection safety glove with high-quality Special Cut Performance PE fibre
- outstanding mechanical abrasion resistance with NBR coating
- good grip in damp and oily areas
- good cut protection due to high-quality Special Cut Performance PE fibre
- good tactile feel
- highly flexible
- good wearer comfort

Art. no.	uvex unidur 6643 60314
Design	knitted cuff
Standard	EN 388 (4 3 4 4 B)
Material	HPPE, polyamide, elastane
Coating	palm and fingertips with NBR coating (nitrile rubber)
Suitable for	damp, oily or greasy areas of application
Colour	mottled grey, black
Sizes	7 to 10
Order quantity multiples	10 PR

uvex unidur 6659 foam

- cut protection glove with NBR foam coating and HPPE/glass fibre
- outstanding mechanical abrasion resistance with NBR coating
- good grip in dry and slightly damp areas
- high level of cut protection with HPPE and glass fibre combination
- very good tactile feel
- highly flexible
- outstanding comfort

Art. no.	uvex unidur 6659 foam 60938
Design	knitted cuff
Standard	EN 388 (4 X 4 4 C)
Material	HPPE, glass, polyamide
Coating	palm and fingertips with nitrile foam coating
Suitable for	dry areas and slightly damp areas
Colour	mottled grey, black
Sizes	6 to 11
Order quantity multiples	10 PR



uvex Chemical Expert System

Consultation and product expertise from a single source

The uvex Glove Navigator

The fast route to finding the right gloves for you
 The uvex Glove Navigator guides you through the entire uvex safety glove range



<https://www.uvex-safety.com/en/products/schutzhandschuhberater/>

uvex Chemical Expert System:

Online chemicals database and glove plans
 As a manufacturer, we offer you access to our extensive on-line chemicals database. In just a few steps, you can access information about the resistance of our safety gloves when handling chemicals.

Register for free and get access to the following premium features:

- Full access to the test results of all listed chemicals
- Creation and management of your own permeation lists
- Use of the glove plan designer: Access the glove plans created by our experts.
- Creation and management of your own glove plans



<https://ces.uvex.de>

uvex Chemical Expert System (online)

Chemicals database for safety gloves

Sort by Hazardous substance ↔ Safety gloves (permeation lists)



Gloves plan designer

Sort by Activity ↔ Safety gloves (glove plans)

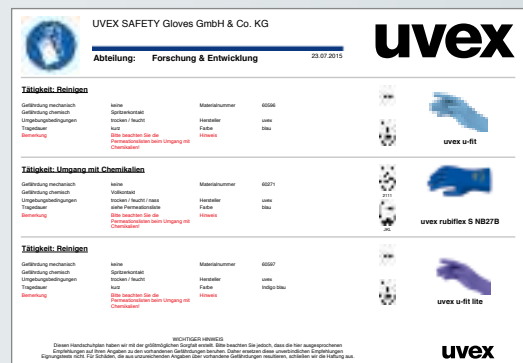



Chemical Risks

Selecting the right hand protection

Chemical protection gloves must be used in a wide variety of areas of application while still enabling wearers to complete tasks effectively.

This is why uvex very pays close attention to the requirements placed on the product in the possible areas of application when developing new chemical protection gloves.

The matrix shown will help you choose the most suitable material for chemical protection gloves:

Handling chemicals	Example industries	Potential contact/splash	Irregular contact	Permanent contact	Explosion-prone area
aliphatic (grease, mineral oil)	Cleaning agents petroleum industry Adhesives Paint production	Nitrile	Nitrile	Nitrile	uvex rubiflex ESD
Polar	Cleaner/universal thinner Loctite/industrial adhesive Coating industry Printing industry Raw materials in the chemical industry Intermediates in the chemical industry	Nitrile Chloroprene	Nitrile Chloroprene	Butyl	uvex profabutyl
polar (alcohols)	Disinfectant, raw materials in the chemical industry	Nitrile Chloroprene	Nitrile Chloroprene	Nitrile Chloroprene Butyl	uvex rubiflex ESD, uvex profabutyl
aromatic, halogenated	Solvents for paints, resins, oils etc. Adhesives Printing and coating industry	Nitrile	Nitrile	Viton	
aqueous solutions, diluted acids/bases	water treatment (sewage plant) commercial cleaning	Nitrile Chloroprene	Nitrile Chloroprene	Nitrile Chloroprene Chloroprene/nitrile	uvex rubiflex ESD
concentrated acids/bases	electroplating surface treatment of aluminium (anodised), steel, raw materials in the chemical industry, fertiliser production, food industry/raw materials in the polymer industry	Nitrile Chloroprene	Nitrile Chloroprene	Nitrile Chloroprene Chloroprene/nitrile Butyl	uvex profabutyl



Chemical Risks

Safety gloves with cotton support: NBR coating

Reinforced construction



89646



89647



89651



MADE IN GERMANY

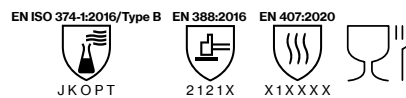

MADE IN GERMANY

uvex rubiflex S

- NBR chemical protection glove with reinforced cotton interlock supporting material
- good mechanical abrasion resistance thanks to the NBR coating
- good resistance to many chemicals, acids, alkalis, mineral oils and solvents
- good heat insulation with reinforced supporting material
- good tactile feel
- ergonomic fit
- outstanding wearer comfort due to the high-quality cotton interlock supporting material
- highly flexible
- certified according to OEKO-TEX® Standard 100 (S02-0648 HOHENSTEIN HTTI)

uvex rubiflex S	NB27S	NB35S	NB40S
Art. no.	89646	98891	98902
Design	gauntlet, approx. 27 cm	gauntlet, approx. 35 cm	gauntlet, approx. 40 cm
Standard	EN 388 (2 1 2 1 X), EN ISO 374-1:2016 / Type A (J K N O P T), EN 407 (X 1 X X X X)		
Material	cotton interlock, reinforced	cotton interlock, reinforced	cotton interlock, reinforced
Coating	fully coated with NBR special coating (nitrile rubber), approx. 0.50 mm	fully coated with NBR special coating (nitrile rubber), approx. 0.50 mm	fully coated with NBR special coating (nitrile rubber), approx. 0.50 mm
Suitable for	very good resistance to grease, mineral oils and many chemicals		
Colour	green	green	green
Sizes	8 to 11	8 to 11	8 to 11
Order quantity multiples	10 PR	10 PR	10 PR

uvex rubiflex S (long version)

- long NBR chemical protection glove with reinforced cotton interlock supporting material
- additional elastic collar at gauntlet end (NB60SZ/NB80SZ)
- good mechanical abrasion resistance thanks to the NBR coating
- good resistance to many chemicals, acids, alkalis, mineral oils and solvents
- good tactile feel
- ergonomic fit
- outstanding wearer comfort due to the high-quality cotton interlock supporting material
- highly flexible
- certified according to OEKO-TEX® Standard 100 (S02-0648 HOHENSTEIN HTTI)

uvex rubiflex S	NB60S	NB80S	NB60SZ	NB80SZ
Art. no.	89647	60190	89651	60191
Design	gauntlet, approx. 60 cm	gauntlet, approx. 80 cm	elastic collar at gauntlet end, approx. 60 cm	elastic collar at gauntlet end, approx. 80 cm
Standard	EN 388 (2 1 2 1 X), EN ISO 374-1:2016/Type B (J K O P T), EN 407 (X 1 X X X X)			
Material	cotton interlock, reinforced	cotton interlock, reinforced	cotton interlock, reinforced	cotton interlock, reinforced
Coating	fully coated with special NBR coating (nitrile rubber), approx. 0.50 mm			
Suitable for	very good resistance to grease, mineral oils and many chemicals			
Colour	green	green	green	green
Sizes	9 to 11	9 to 11	9 to 11	9 to 11
Order quantity multiples	10 PR	10 PR	10 PR	10 PR

Chemical Risks

Safety gloves with cotton support: NBR coating



Exceptional grip

60557



Lightweight and flexible

60224

LABS-conformity VDMA
24364-A1/A2-L/W

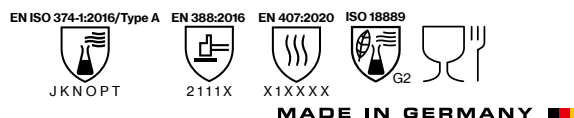
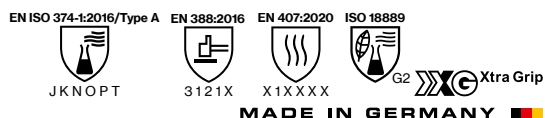

uvex rubiflex S XG

- lightweight, stockinette NBR chemical protection glove with optimal grip properties
- very good mechanical abrasion resistance and good lifecycle thanks to multi-layered structure
- outstanding grip in wet and oily areas thanks to uvex Xtra Grip technology
- good resistance to grease, mineral oils and many chemicals
- very good tactile feel
- ergonomic fit
- outstanding wearer comfort due to the high-quality cotton interlock supporting material
- extremely high flexibility
- certified according to OEKO-TEX® Standard 100 (S02-0648 HOHENSTEIN HTTI)

	uvex rubiflex S XG27B	uvex rubiflex S XG35B
Art. no.	60560	60557
Design	gauntlet, approx. 27 cm	gauntlet, approx. 35 cm
Standard	EN 388 (3 1 2 1 X)	EN 388 (3 1 2 1 X), ISO 18889 (G2)
	EN ISO 374-1:2016/Type A (J K N O P T), EN 407 (X 1 X X X X)	
Material	cotton interlock	cotton interlock
Coating	fully coated with special NBR coating (nitrile rubber) and XG Grip coating, approx. 0.40 mm	fully coated with special NBR coating (nitrile rubber) and XG Grip coating, approx. 0.40 mm
Suitable for	very good resistance to grease, mineral oils and many chemicals	very good resistance to grease, mineral oils and many chemicals
Colour	blue, black	blue, black
Sizes	7 to 11	7 to 11
Order quantity multiples	10 PR	10 PR

uvex rubiflex S

- very lightweight, stockinette NBR chemical protection glove suited to handling a variety of chemicals
- good mechanical abrasion resistance thanks to the NBR coating
- good grip in damp and wet areas
- good resistance to grease, mineral oils and many chemicals
- outstanding tactile feel
- ergonomic fit
- outstanding wearer comfort due to the high-quality cotton interlock supporting material
- extremely high flexibility
- certified according to OEKO-TEX® Standard 100 (S02-0648 HOHENSTEIN HTTI)

	uvex rubiflex S NB27B	uvex rubiflex S NB35B
Art. no.	60271	60224
Design	gauntlet, approx. 27 cm	gauntlet, approx. 35 cm
Standard	EN 388 (2 1 1 1 X)	EN 388 (2 1 1 1 X), ISO 18889 (G2)
	EN ISO 374-1:2016/Type A (J K N O P T), EN 407 (X 1 X X X X)	
Material	cotton interlock	cotton interlock
Coating	fully coated with special NBR coating (nitrile rubber), approx. 0.40 mm	fully coated with special NBR coating (nitrile rubber), approx. 0.40 mm
Suitable for	good resistance to grease, mineral oils and many chemicals	good resistance to grease, mineral oils and many chemicals
Colour	blue	blue
Sizes	7 to 11	6 to 11
Order quantity multiples	10 PR	10 PR



Chemical Risks

Safety gloves with bamboo-fiber/nylon support: NBR coating



60971



60972



60968

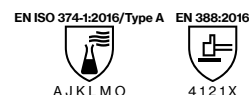
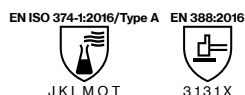

uvex u-chem 3300

- outstanding wearer comfort
- comfortable bamboo-fiber inside
- absorption function of the natural fiber
- extremely high dexterity
- outstanding tactile feel good resistance to many chemicals

uvex u-chem 3200

- best grip in oily conditions
- flexibility and grip
- good mechanical properties
- excellent fit

uvex u-chem 3100

- the perfect combination of chemical protection and grip
- very good mechanical protection
- comfortable fit due to seamless cotton liner
- good resistance to many chemicals
- very good grip in wet and oily conditions
- highly flexible

Art. no.	uvex u-chem 3300 60971
Design	cuff, fully coated, approx. 32 cm
Standard	EN 388 (2 1 2 1 X), EN ISO 374-1:2016 / Type A (J K L O P T)
Material	Bamboo-rayon/Nylon (seamless)
Coating	NBR (nitrile butadiene rubber), approx. 0.21 mm
Suitable for	good resistance to grease, mineral oils and many chemicals
Colour	blue
Sizes	7 to 11
Order quantity multiples	10 PR

Art. no.	uvex u-chem 3200 60972
Design	cuff, fully coated, approx. 35 cm
Standard	EN 388 (3 1 3 1 X), EN ISO 374-1:2016 / Type A (J K L M O T)
Material	nylon weave (seamless)
Coating	NBR (nitrile butadiene rubber), approx. 0.50 mm
Suitable for	good resistance to grease, mineral oils and many chemicals
Colour	petrol, black
Sizes	7 to 11
Order quantity multiples	10 PR

Art. no.	uvex u-chem 3100 60968
Design	cuff, fully coated, approx. 30 cm
Standard	EN 388 (4 1 2 1 X), EN ISO 374-1:2016 / Type A (A J K L M O)
Material	cotton (seamless)
Coating	NBR (nitrile butadiene rubber), approx. 0.50 mm
Suitable for	good resistance to grease, mineral oils and many chemicals
Colour	black
Sizes	8 to 11
Order quantity multiples	10 PR

Chemical Risks

Safety gloves with cotton interlock lining material: CR/NBR coating



LABS-conformityVDMA
24364-A1/A2-L/W

60188



uvex u-chem 3500

- sensitive NBR broadband chemical protection glove (protection against 11 of 18 test chemicals). Material combination of nitrile and chloroprene protects against alcohols, aliphatic hydrocarbons, and concentrates acids and bases with a permeation time of ≥ 120 minutes.
- protection against contact heat 100 ° C (Level 1)
- very good fit, very high wearing comfort thanks to seamless cotton liner

	uvex u-chem 3500
Art. no.	60188
Design	cuff, fully coated, approx. 32cm
Standard	EN ISO 374-1:2016 / Typ A (A C J K L M N O P S T), EN ISO 374-5:2016 VIRUS, EN 388 (3 1 2 1 X), EN 407 (X 1 X X X X)
Material	cotton (seamless)
Coating	fully coated with Chloroprene and NBR (nitrile butadiene rubber), approx. 0.40 mm
Suitable for	good resistance to acetone, cleaning agents, adhesives, solvents
Colour	orange
Sizes	7 to 11
Order quantity multiples	10 PR

Chemical Risks

Safety gloves with cotton support: conductive NBR coating

The ideal solution for areas with explosive atmospheres

The introduction of the new standard EN 16350:2014 (Protective gloves – electrostatic properties) is the first standard to prescribe the electrostatic properties and testing procedure of safety gloves for work environments with risk of explosive atmospheres and fire.

- The testing conditions and minimum requirements in accordance with EN 16350:2014 are as follows:
- The contact resistance must be less than $1.0 \times 10^8 \Omega$ ($R_V < 1.0 \times 10^8 \Omega$).
- Contact resistance R_V was tested in accordance with EN 1149-2:1997.
- Test atmosphere: ambient temperature $23^\circ\text{C} \pm 1^\circ\text{C}$, relative air humidity $25\% \pm 5\%$.

uvex rubiflex ESD fulfils the requirements of the new norm EN 16350:2014.



Functional combination of liner and coating

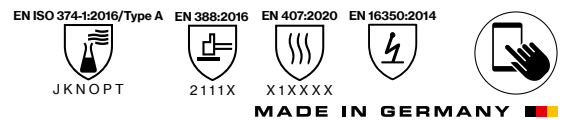
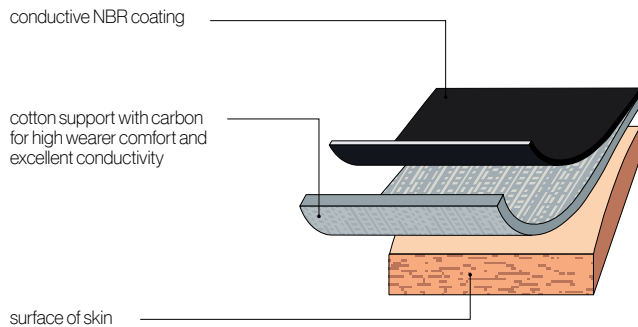

uvex rubiflex ESD

- lightweight, stockinette and anti-static NBR chemical protection glove for applications in areas with explosion risks
- good mechanical abrasion resistance thanks to the NBR coating
- good grip in damp and wet areas
- good resistance to grease, mineral oils and many chemicals
- outstanding tactile feel
- ergonomic fit
- outstanding wearer comfort due to the high-quality cotton interlock/carbon supporting material
- extremely high flexibility
- certified according to OEKO-TEX® Standard 100 (S02-0648 HOHENSTEIN HTTI)

uvex rubiflex ESD	NB27A	NB35A
Art. no.	60880	60954
Design	gauntlet, approx. 27 cm	gauntlet, approx. 35 cm
Standard	EN 388 (2 111 X), EN ISO 374-1:2016 / Type A (J K N O P T), EN 16350, EN 407 (X 1 X X X X)	
Material	cotton interlock/carbon	cotton interlock/carbon
Coating	fully coated with special conductive NBR coating (nitrile rubber), approx. 0.40 mm	
Suitable for	good resistance to grease, mineral oils and many chemicals	
Colour	black	black
Sizes	6 to 11	6 to 11
Order quantity multiples	10 PR	10 PR

Chemical Risks

Unsupported safety gloves



60949



60957

EN ISO 374-1:2016/Type A EN 388:2016 EN 16350:2014



ABIKLNOT



2010X



MADE IN GERMANY

EN ISO 374-1:2016/Type A EN 388:2016



AFKLMN



2120A

MADE IN GERMANY



uvex profabutyl

- chemical protection glove without stockinette made from butyl rubber
- good grip in damp and wet areas
- good resistance to polar bonds such as esters, ketones, aldehydes, amines and saturated saline solutions, plus acids and alkalis
- good fit
- highly flexible
- satisfies the requirements of DIN EN 16350:2014

Art. no.	uvex profabutyl B-05R 60949
Design	gauntlet, rolled edge, approx. 35 cm
Standard	EN 388 (2 0 1 0 X), EN 374 (A B I K L N O T), EN 16350
Material	without stockinette
Coating	seamlessly coated with bromobutyl (approx. 0.50 mm)
Suitable for	good resistance to polar bonds acids and alkalis
Colour	black
Sizes	7 to 11
Order unit	PR

uvex profaviton

- chemical protection gloves made from butyl rubber with Viton® outer layer
- good grip in damp and wet areas
- good resistance to aliphatic and aromatic hydrocarbons (e.g. hexane, benzene, toluene, xylene and others), halogenated hydrocarbons (e.g. trichloroethylene, perchloroethylene, dichloromethane and others) organic and inorganic acids (diluted to concentrated), as well as saturated saline solutions
- good fit
- highly flexible

Art. no.	uvex profaviton BV-06 60957
Design	gauntlet, rolled edge, approx. 35 cm
Standard	EN 388 (2 1 2 0 A), EN ISO 374-1:2016/Type A (A F K L M N)
Material	without stockinette
Coating	seamlessly coated with bromobutyl (approx. 0.40 mm) and Viton® outer layer (approx. 0.20 mm)
Suitable for	good resistance to aliphatic and aromatic hydrocarbons, halogenated hydrocarbons
Colour	black
Sizes	8 to 11
Order unit	PR

Chemical Risks

Area of application: cut protection



60535

60536

EN ISO 374-1:2016/Type A EN 388:2016



MADE IN GERMANY

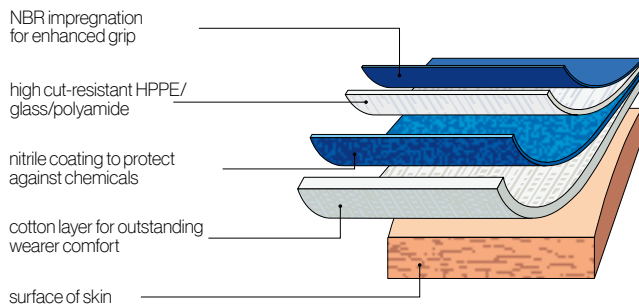

uvex protector chemical

- very robust safety glove with multi-layer technology combining impermeability and optimal cut protection
- very high level of cut protection with the multi-layer design of the supporting material made from cotton, HPPE and glass
- good grip in damp, wet and oily areas
- uvex protector chemical also offers protection against chemicals
- good wearer comfort
- certified according to OEKO-TEX® Standard 100 (S02-0648 HOHENSTEIN HTTI)

	uvex protector chemical NK2725B	uvex protector chemical NK4025B
Art. no.	60535	60536
Design	gauntlet, approx. 27 cm	gauntlet, approx. 40 cm
Standard	EN 388 (4 X 4 4 C), EN ISO 374-1:2016/ Type A (J K N O P T)	EN 388 (4 X 4 4 C), EN ISO 374-1:2016/ Type A (J K N O P T)
Material	sandwich liner: cotton interlock, HPPE, glass, PA	
Coating	fully coated with special NBR coating (nitrile rubber)	
Suitable for	good resistance to oil, grease and many chemicals	
Colour	blue	blue
Sizes	9 to 10	9 to 10
Order quantity multiples	10 PR	10 PR

Chemical Risks

Unsupported safety gloves



60122



60119

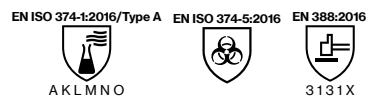

uvex profastrong

- sensitive NBR chemical protection glove with flocked cotton
- outstanding mechanical abrasion resistance
- good grip in damp and wet areas thanks to the Grip structure in the palm
- good resistance to many oils, grease, acids and alkalis
- good tactile feel
- good fit
- highly flexible

uvex profapren

- flexible chloroprene chemical protection glove with flocked cotton
- good grip in damp and wet areas thanks to the Grip structure in the palm
- good resistance to many chemicals and solvents
- good tactile feel
- very good fit
- highly flexible

Art. no.	uvex profastrong NF33 60122
Design	gauntlet, palm with grip structure, approx. 33 cm
Standard	EN 388 (4 1 0 1 X), EN ISO 374-1:2016/Type A (A J K L O T), EN ISO 374-5:2016 VIRUS
Material	flocked cotton
Coating	fully coated with NBR (nitrile rubber), approx. 0.38 mm
Suitable for	good resistance to oils, grease, acids and solvents
Colour	green
Sizes	7 to 11
Order quantity multiples	12 PR

Art. no.	uvex profapren CF33 60119
Design	gauntlet, roughened palm, approx. 33 cm
Standard	EN 388 (3 1 3 1 X), EN ISO 374-1:2016/Type A (A K L M N O), EN ISO 374-5:2016
Material	flocked cotton
Coating	fully coated with polychloroprene (latex inner), approx. 0.71 mm
Suitable for	good resistance to many chemicals
Colour	dark blue
Sizes	7 to 10
Order quantity multiples	10 PR



Chemical Risks

Disposable safety gloves

The uvex u-fit product range, provides high-quality disposable safety gloves, which guarantee a high level of safety and functionality.

uvex u-fit gloves ensures reliable wearer protection throughout industry, including the chemical, medical, food and light industry sectors enabling comfortable and precise work.

uvex disposable safety gloves are available in four different materials to cater for a wide range of application areas:

- uvex u-fit lite
- uvex u-fit
- uvex u-fit ft
- uvex u-fit strong N2000

	uvex u-fit lite	uvex u-fit	uvex u-fit ft	uvex u-fit strong N2000
Material	accelerator-free NBR (nitrile rubber)	NBR (nitrile rubber)	NBR (nitrile rubber)	NBR (nitrile rubber)
	wall thickness 0.06 mm	wall thickness 0.10 mm	wall thickness 0.10 mm	wall thickness 0.20 mm
Certification	EN ISO 374	EN ISO 374	EN ISO 374	EN ISO 374
	EN 455	EN 455	EN 455	EN 455
	handling foodstuffs	handling foodstuffs	handling foodstuffs	handling foodstuffs
	compliance with MDR (EU) 2017/745	-	compliance with MDR (EU) 2017/745	-
Characteristics	high level of sensitivity	good mechanical abrasion resistance	good mechanical abrasion resistance	very good abrasion resistance
	hypo-allergenic	good chemical resistance	good chemical resistance	increased chemical resistance
Handling	reinforced rolled edge – easy to put on	reinforced rolled edge – easy to put on	reinforced rolled edge – easy to put on	reinforced rolled edge – easy to put on



Please contact us if you require a copy of our complete resistance list.

Detailed information can also be found in the uvex Chemical Expert System online at <https://ces.uvex.de>

Area of application	uvex u-fit lite	uvex u-fit	uvex u-fit ft	uvex u-fit strong N2000
Intended for medical examinations and to prevent infections between users and patients	++	-	++	-
Precision assembly work, dry/oily	++	+	+	-
Assembly work, dry/oily	+	+	+	++
Product protection	++	++	++	+
Gentle cleaning	+	+	+	++
Inspection	++	++	++	+
Food handling	+	+	+	+
Chemicals	short-term work, in acc. with resistance list	short-term work, in acc. with resistance list	short-term work, in acc. with resistance list	in acc. with resistance list
Paint shop	as splash protection	as splash protection	as splash protection	full contact in acc. with resistance list

Chemical Risks

Disposable safety gloves

Accelerator-free



60597

uvex u-fit lite

- nitrile examination and safety gloves single use (0.06 mm)
- non-sterile, can be used on both sides, powder-free
- free from natural latex
- free from allergenic accelerators.
- good grip with the roughened fingertips
- LABS-conformity in accordance with VDMA 24364 A2-L

EN ISO 374-1:2016 / Type B EN ISO 374-5:2016



	uvex u-fit lite
Art. no.	60597
Design	roughened fingertips, approx. 24 cm
Standard	EN ISO 374-1:2016/Type B (K P T), EN 374-5:2016 VIRUS
Material	without stockinette
Coating	NBR (nitrile rubber), approx. 0.06 mm
Suitable for	highly resistant to grease and oil, good resistance to chemicals, for medical examinations and to prevent infections between users and patients
Colour	indigo blue
Sizes	S to XL
Order unit	BOX
Content	box of 100 PC



60596

uvex u-fit

- nitrile single-use safety gloves (0.10 mm)
- non-sterile, can be used on both sides, powder-free
- free from natural latex
- good grip with the roughened surface
- LABS-conformity in accordance with VDMA 24364 A2-L

EN ISO 374-1:2016 / Type B EN ISO 374-5:2016



	uvex u-fit
Art. no.	60596
Design	roughened surface, approx. 24 cm
Standard	EN ISO 374-1:2016/ Type B (K P T), EN 374-5:2016 VIRUS
Material	without stockinette
Coating	NBR (nitrile rubber), approx. 0.10 mm
Suitable for	highly resistant to grease and oil, good resistance to chemicals
Colour	blue
Sizes	S to XL
Order unit	BOX
Content	box of 100 PC



60166

uvex u-fit ft

- nitrile single-use examination and safety gloves (0.10 mm)
- non-sterile, can be used on both sides, powder-free
- free from natural latex
- good grip with the roughened fingertips
- LABS-conformity in accordance with VDMA 24364 A1/A2/A3 L/W

EN ISO 374-1:2016 / Type B EN ISO 374-5:2016



	uvex u-fit ft
Art. no.	60166
Design	roughened fingertips, approx. 24 cm
Standard	EN ISO 374-1:2016/ Type B (J K P T), EN 374-5:2016 VIRUS
Material	without stockinette
Coating	NBR (nitrile rubber), approx. 0.10 mm
Suitable for	highly resistant to grease and oil, good resistance to chemicals, for medical examinations and to prevent infections between users and patients
Colour	blue
Sizes	XS to XL
Order unit	BOX
Content	box of 100 PC



60962

uvex u-fit strong N2000

- nitrile single-use safety gloves (0.20 mm)
- non-sterile, can be used on both sides, powder-free
- free from natural latex
- good grip with the roughened fingertips
- LABS-conformity in accordance with VDMA 24364 A2-L/W

EN ISO 374-1:2016 / Type A EN ISO 374-5:2016



	uvex u-fit strong N2000
Art. no.	60962
Design	textured surface of fingertips, approx. 28 cm
Standard	EN ISO 374-1:2016/Type A (J K L O P S T), EN 374-5:2016 VIRUS
Material	no lining
Coating	NBR (nitrile butadiene rubber), approx. 0.20 mm
Suitable for	highly resistant to grease and oil, increased resistance to chemicals
Colour	blue
Sizes	S to XXL
Order unit	BOX
Content	box of 50 PC

Safety Gloves

Needlestick



Page 246	Page 246	Page 246	Page 247	Page 247	Page 247
HexArmor PointGuard® Ultra 9032	HexArmor SharpsMaster II® 9014	HexArmor Arm Guard AG8TW	HexArmor PointGuard® Ultra 4043U	HexArmor PointGuard® Ultra 4045	HexArmor Hercules® NSR 3041

Cut protection



Page 248	Page 248	Page 248
HexArmor Helix® 2082	HexArmor Helix® 2065	HexArmor Helix® 2076

Cut protection



Page 249	Page 249	Page 249	Page 250	Page 250	Page 250	Page 251	Page 251	Page 251
HexArmor Helix® 3033	HexArmor Helix® 2062	HexArmor Chrome SLT® 4062	HexArmor Chrome Series® 4023M	HexArmor ThornArmor 3092	HexArmor Arm Guard AG10009S	HexArmor 9000 Series 9013	HexArmor Chrome SLT 4070	HexArmor Thin Lizzie™ Thermal 2099

Impact



Page 252	Page 252	Page 252	Page 253	Page 253	Page 253	Page 254	Page 254	Page 254
HexArmor Helix® 1095	HexArmor Rig Lizard® 7101	HexArmor Thin Lizzie™ Fluid 7102	HexArmor Helix® 3000	HexArmor Helix® 3003	HexArmor Helix® 3007	HexArmor Thin Lizzie™ 2090X	HexArmor Thin Lizzie™ 2095X	HexArmor Rig Lizard® 2038



Page 255	Page 255	Page 255
HexArmor Rig Lizard® 2021X	HexArmor Rig Lizard® 2039	HexArmor Chrome 4026



A Cut Above

HexArmor® is an exclusive licensee of SuperFabric® brand material in the industrial PPE market. HexArmor® products with SuperFabric® brand material have a secret weapon against cut hazards that no other glove can boast. SuperFabric® technology is designed to prevent lacerations and slashes from reaching the skin. Performance is enhanced through the configuration of tiny guard plates.

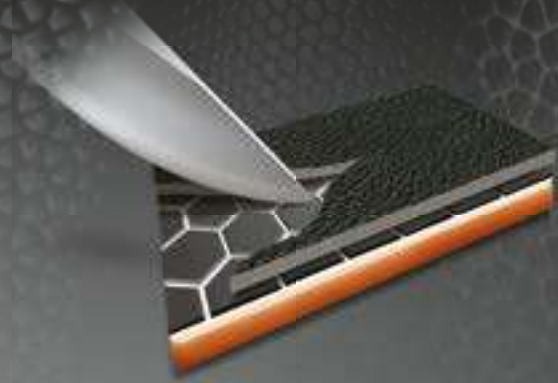

Impact Resistance

Impacts come in all forms, shapes, and magnitudes for workers. Whether caused by falling tools, equipment or pinches, impact injuries have one thing in common: unpredictability. Individuals must always be prepared and protected from impact and pinch points, and the patented IR-X® Impact Exoskeleton™ from HexArmor® has proven to reduce the number and effects of injuries.

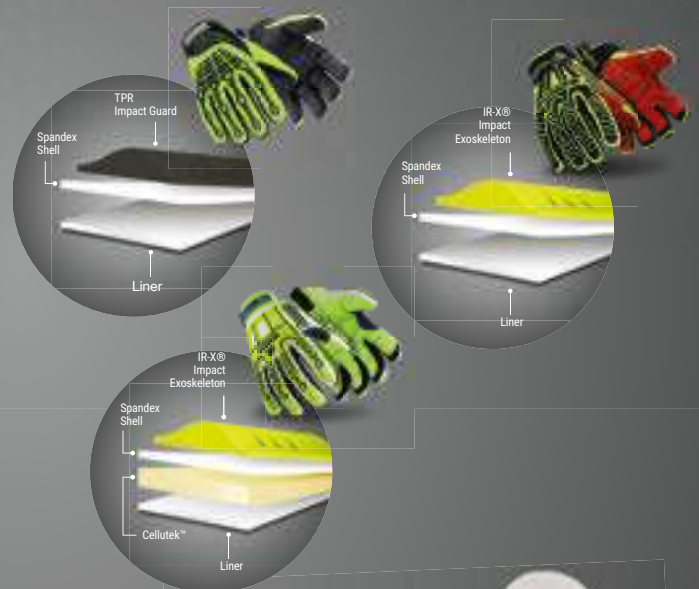

Needlestick Resistance

Needles are sharp, beveled cutting instruments designed to pierce the skin. HexArmor® needle resistant products work by layering SuperFabric® brand materials over each other. SuperFabric® brand material guardplates block and deflect needle hazards or trap and arrest them in the small gaps found between guardplates. Multiple aligned layers of fabric provide extra resistance against needle hazards.

HexArmor® products are tested in real world applications and are proven to reduce needlestick injuries. Using the correct test will ensure you have the right glove to protect your employees. As always, we recommend proper field testing to validate the appropriate level of protection necessary for your application.



Two brands with one global mission:
protecting people
HexArmor® + uvex

uvex and HexArmor® – two brands with one global mission: protecting people. We now offer a select range of safety gloves from HexArmor's portfolio to all uvex customers in the Eastern Hemisphere (Europe, Africa, Middle East and Russia). View the HexArmor® safety gloves range at www.uvex-safety.com/en/hexarmor



Detailed information can be found at <https://www.uvex-safety.com/en/hexarmor>



Cut resistance: Comparison between EN 388-2016 and ANSI/ISEA 105-2016

When comparing the cut resistance of two or more fabrics, it is important to make sure that for all materials:

- The same test method was used
- The same type of cut tester was used

Unless these points are met, you cannot accurately compare the results.

Cut resistance levels: The use of the TDM-100 test method is required by both ANSI/ISEA 105 and by EN 388 (for high-cut materials). However, the ANSI/ISEA standard reports results in grams on an A1-A9 scale (200-6000 grams/2-60 Newtons). While the A1-A9 scale is comparable to the EN 388 A-F levels which reports up to 30 Newtons (200-3000 grams/2-30 Newtons), ANSI/ISEA extends their scale by three levels to 6000 grams/60 Newtons to report high cut materials more accurately.

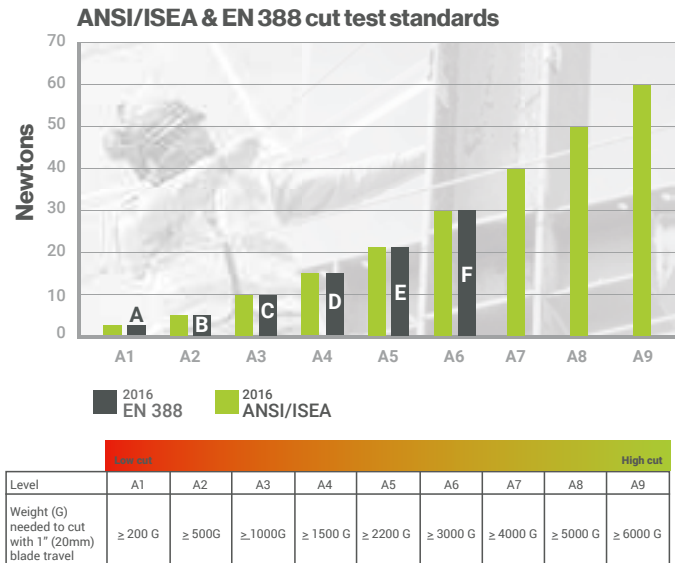

Puncture & Needle Testing Explained

The ANSI/ISEA 105 Test

In February of 2016, the ANSI/ISEA 105 standard was updated and published to include two puncture standards: Puncture Resistance (other than hypodermic needle) and Hypodermic Needlestick Puncture. Prior to 2015, there was only one puncture test, which did not specify the type of puncture hazard the standard was created for, leaving it open for interpretation. Having both an industrial puncture standard and a hypodermic needle puncture standard allows safety managers to differentiate between what protection they need most, based on more relevant testing and classification.



EN 388: Industrial Puncture Resistance (Non-Hypodermic Needlestick Puncture)

The EN 388 probe is the approved puncture test for ANSI/ISEA 105 and measures the amount of force needed for a blunt probe to pierce through the sample material (taken from palm).

- The blunt probe moves at a 90° angle at a speed of 100mm/minute
- Results are reported in Newtons and are given a 1-5 classification rating, with 1 being low resistance and 5 being high resistance
- The test is done 4 times for every palm sample
- The lowest score is reported



ASTM F2878: Hypodermic Needlestick Puncture Resistance

The ASTM F2878 is the approved puncture test for ANSI/ISEA 105 and measures the amount of force needed for a 25-gauge hypodermic needle to pierce through the sample material.

- The puncture probe (25-gauge needle) travels at a 90° angle into specimen at a vector of 500 millimeters per minute.
- Results are reported in Newtons and are giving a 1-5 classification rating, with 1 being low resistance and 5 being high resistance
- The test is done 12 times for every palm sample
- The average of the 12 results is reported

Impact protection

Back-of-hand bones and soft tissues are extremely vulnerable to impact-related hand injuries among a wide range of job sites. This U.S.-based impact performance standard will help safety professionals make better-informed decisions about glove selection – ultimately keeping more people safe on the job.

Impact protection: ANSI/ISEA 138

The ISEA 138 standard establishes the minimum performance, classification, and labeling requirements for gloves that are designed to protect the knuckles and fingers from impacts based on three performance levels.

How the test works: To score gloves into their appropriate level, impact protection testing under ISEA 138 requires consistent, regulated tests on each kind of glove on two areas for impact performance: knuckles and fingers/thumb. On both gloves, knuckles are tested four times and fingers/thumb are tested five times.

To start, one pair of gloves is required per test. The gloves are cut in half and the back-of-hand (where the impact protection is located) is placed on an anvil. A striker with a force of 5 Joules is dropped on the required back-of-hand locations, and the amount of force transferred through the glove back-of-hand is recorded with a force gauge that is connected below the anvil and measured in kiloNewtons (kN).

Scoring: The average of eight knuckle tests are compared to the average of the ten finger tests. The highest average of the two is the impact testing score.

- **Performance Level 1** – Results in an average peak transmitted force of less than or equal to 9 kN.
 - 55% of force absorbed
- **Performance Level 2** – Results in an average peak transmitted force of less than 6.5 kN.
 - 67.5% of force absorbed
- **Performance Level 3** – Results in an average peak transmitted force of less than 4 kN.
 - 80% of force absorbed

The chart showcases the ISEA 138 performance levels, with "Performance Level 3" being the highest. Any impact-resistant PPE that scores higher than a 9 kN force transfer will not qualify for a ranking and will fail. With no impact material, the machine registers around 20kN, so in order to pass the test, the impact material must register less than 9kN, reducing the force or energy transferred by 55%. The anvil will drop roughly around 5 ½ pounds from 8 inches.

Impact protection: EN 388

The European industrial glove market includes impact testing performance ratings in EN 388, which tests the impact on just the knuckles, and the tests are given a basic score of pass or fail. To pass the test, the transmitted force needs to be less than or equal to 7 kN with no single results greater than 9 kN.

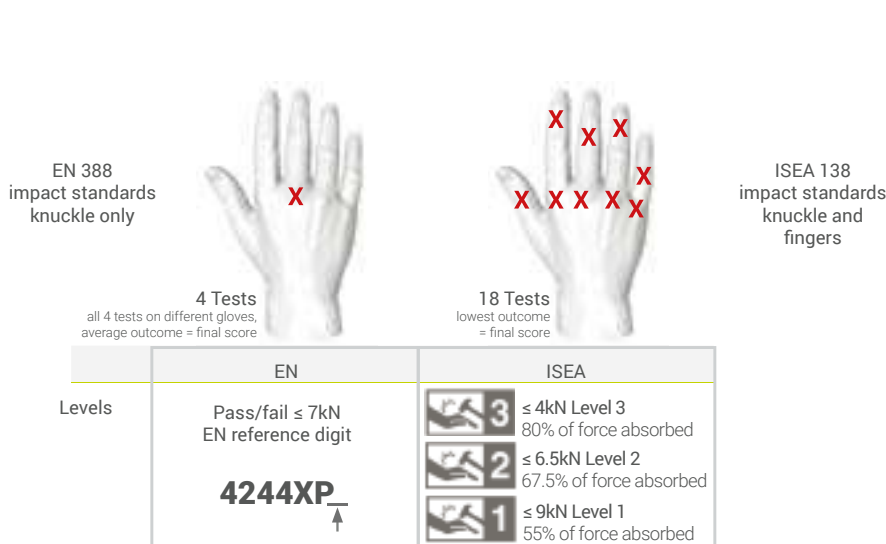

Needlestick Series



60638



60982



60981



4 X 4 3 F

3 Layers SuperFabric® Protection

ANSI/ISEA CUT	GRAM SCORE	ANSI/ISEA PUNCTURE
A9	7167	4
NEEDLESTICK	NEWTONS	
LEVEL 5	11.143	



4 X 4 4 F

3 Layers SuperFabric® Protection

ANSI/ISEA CUT	GRAM SCORE	ANSI/ISEA PUNCTURE
A9	7167	5
NEEDLESTICK	NEWTONS	
LEVEL 5	10.279	



4 X 1 1 F

2 Layers SuperFabric® Protection

ANSI/ISEA CUT	GRAM SCORE	ANSI/ISEA PUNCTURE
A8	5254	2
NEEDLESTICK	NEWTONS	
LEVEL 2	5.5125	

9032

Article No. 60638

PointGuard® Ultra

- SuperFabric® brand material provides industry-leading needlestick resistance (in noted enhanced areas)
- Single-glove needle solution with incredible dexterity and comfort
- Sandy nitrile three-quarter knuckle coating

	PointGuard® Ultra 9032
Article No.	60638
Standard	EN 388: 2016 (4 X 4 3 F)
Colour	yellow/blue
Sizes	7/S through 11/XXL
Order quantity multiples	1 PR

9014

Article No. 60981

SharpsMaster II®

- SuperFabric® brand material provides industry-leading needlestick resistance (in noted enhanced areas)
- Cotton blend shell provides exceptional dexterity and feel
- Wrinkle rubber latex palm coating

	SharpsMaster II® 9014
Article No.	60981
Standard	EN 388: 2016 (4 X 4 4 F)
Colour	white/orange
Sizes	6/XS through 10/XL
Order quantity multiples	1 PR

AG8TW

Article No. 60982

Arm Guard

- SuperFabric® brand material provides industry-leading needlestick resistance
- Won't fall down like knit sleeves
- Spandex wrist insert with thumb hole and snap fasteners

	AG8TW Arm Guard
Article No.	60982
Standard	EN 388: 2016 (4 X 1 1 F)
Colour	black
Sizes	7/S through 12/3XL
Order quantity multiples	1 PC

Needlestick Series



60672



60983



60005



	ANSI/ISEA CUT	GRAM SCORE	ANSI/ISEA PUNCTURE
	A9	6679	3
	NEEDLESTICK	NEWTONS	
	LEVEL 5	11.546	
	3 Layers SuperFabric®	3 Layers SuperFabric®	
	LEVEL 3	6.9	
	2 Layers SuperFabric®	2 Layers SuperFabric®	

	ANSI/ISEA CUT	GRAM SCORE	ANSI/ISEA PUNCTURE
	A7	4321	3
	NEEDLESTICK	NEWTONS	
	LEVEL 2	5.284	
	SuperFabric®	SuperFabric®	
	LEVEL 3	6.9	
	2 Layers SuperFabric®	2 Layers SuperFabric®	

	ANSI/ISEA CUT	GRAM SCORE	ANSI/ISEA PUNCTURE
	A9	8668	3
	NEEDLESTICK	NEWTONS	
	LEVEL 5	11.59	



4043U

Article No. 60672

PointGuard® Ultra

- SuperFabric® brand material provides industry-leading needlestick resistance (in noted enhanced areas)
- Back-of-hand knuckle padding for incidental bumps/impact
- Synthetic leather palm
- Neoprene cuff with Velcro® closure

	PointGuard® Ultra 4043U
Article No.	60672
Standard	EN 388: 2016 (4 X 4 2 F)
Colour	black
Sizes	7/S through 11/XXL
Order quantity multiples	1 PR

4045

Article No. 60005

PointGuard® Ultra

- SuperFabric® brand material provides industry-leading needlestick resistance (in noted enhanced areas)
- Back-of-hand knuckle padding for incidental bumps/impact
- Silicone palm pattern for enhanced grip
- Neoprene cuff with Velcro® closure

	PointGuard® Ultra 4045
Article No.	60005
Standard	EN 388: 2016 (4 X 2 2 F)
Colour	black
Sizes	6/XS through 12/3XL
Order quantity multiples	1 PR

3041

Article No. 60983

Hercules® NSR

- SuperFabric® brand material provides industry-leading needlestick resistance (in noted enhanced areas)
- Full coverage design and pre-curved shape for maximum comfort and protection
- Silicone dot palm grip

	Hercules® NSR 3041
Article No.	60983
Standard	EN 388: 2016 (4 X 1 2 F)
Colour	black
Sizes	7/S through 11/XXL
Order quantity multiples	1 PR

Cut protection Series



60614



60660



60659

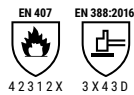

42312X 3X43D



4X42D



4X44F

Aramid Blend Shell

ANSI/ISEA CUT	GRAM SCORE	ANSI/ISEA PUNCTURE
A3	1147	4

HPPE Blend Shell

ANSI/ISEA CUT	GRAM SCORE	ANSI/ISEA PUNCTURE
A3	1274	3

HPPE Blend Shell

ANSI/ISEA CUT	GRAM SCORE	ANSI/ISEA PUNCTURE
A6	3276	5

2082

Article No. 60614

Helix®

- 13-gauge flame-resistant aramid and wool blend shell*
- Flexible FR-compliant neoprene/nitrile blend palm coating

*Hazard risk category HRC 1 arc flash protection (ATPV 7.7 cal/cm², as per ASTM F2675/F2675M-13, determining arc flash rating of hand-protective devices)

2065

Article No. 60659

Helix®

- 13-gauge HPPE and fiberglass shell
- Flexible sandy nitrile palm coating
- Full flat nitrile coating offers 360° water resistance

2076

Article No. 60660

Helix®

- 13-gauge HPPE, steel, and fiberglass blend shell
- Flexible polyurethane palm coating
- Reinforced thumb croch patch

Helix® 2082	
Article No.	60614
Standard	EN 388: 2016 (3 X 4 3 D), EN 407 (4 2 3 1 2 X)
Colour	green mottled/black
Sizes	7/S through 11/XXL
Order quantity multiples	1 PR

Helix® 2065	
Article No.	60659
Standard	EN 388: 2016 (4 X 4 2 D)
Colour	blue/black
Sizes	6/XS through 12/3XL
Order quantity multiples	1 PR

Helix® 2076	
Article No.	60660
Standard	EN 388: 2016 (4 X 4 4 F)
Colour	blue mottled/black
Sizes	5/XXS through 13/4XL
Order quantity multiples	1 PR

Cut protection Series



60661



60668



60655

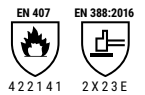

HPPE Blend Shell

ANSI/ISEA CUT	GRAM SCORE	ANSI/ISEA PUNCTURE
A6	3825	4

Coretex™ Shell

ANSI/ISEA CUT	GRAM SCORE	ANSI/ISEA PUNCTURE
A9	6437	5

Aramid Liner

ANSI/ISEA CUT	GRAM SCORE	ANSI/ISEA PUNCTURE
A5	2509	4



3033

Article No. 60668

Helix®

- Engineered knit to specifically prevent glove particles from contacting food (outer layer tested to FDA 21 CFR 177.1630 for food safe contact)
- Seamless construction for enhanced comfort and breathability
- Can be used in direct contact with food or as an underglove with appropriate top-glove solution

	Helix® 3033
Article No.	60668
Standard	EN 388: 2016 (3 X 4 1 E)
Colour	mottled blue
Sizes	6/XS through 11/2XL
Order quantity multiples	1 PR

2062

Article No. 60661

Helix®

- Coretex™ (13G HPPE, steel, and fiberglass blend) shell for industry-leading 360° cut resistance
- Flexible sandy nitrile palm coating
- Hi-vis color on back-of-hand

	Helix® 2062
Article No.	60661
Standard	EN 388: 2016 (4 X 4 4 F)
Colour	yellow/black
Sizes	6/XS through 12/3XL
Order quantity multiples	1 PR

4062

Article No. 60655

Chrome SLT®

- Arc Flash Level 4 Rating: Lab tested in accordance with HRC ATPV at 46 Cal/cm²
- Goatskin leather palm provides a traditional style of comfort and grip
- Stitched with Aramid thread
- Full aramid liner for 360° cut protection
- Extended safety cuff for easy on and off

	Chrome SLT® 4062
Article No.	60655
Standard	EN 388: 2016 (2 X 2 3 E), EN 407 (4 2 2 1 4 1)
Colour	beige
Sizes	6/XS through 12/3XL
Order quantity multiples	1 PR

Cut protection Series



60673



60985



60010



SuperFabric® Protection Zone

ANSI/ISEA CUT	GRAM SCORE	ANSI/ISEA PUNCTURE
A8	5374	2

3 Layers SuperFabric® Protection

ANSI/ISEA CUT	GRAM SCORE	ANSI/ISEA PUNCTURE
A3	1274	3
NEEDLESTICK	NEWTONS	
LEVEL 5	11.94	

SuperFabric® Protection Zone

ANSI/ISEA CUT	GRAM SCORE	ANSI/ISEA PUNCTURE
A7	4425	3
ANSI/ISEA ABRASION	ANSI/ISEA CONTACT HEAT	
6	2	

4023M

Article No. 60673

Chrome

- SuperFabric® brand material provides 360° industry-leading cut resistance (interior layer)
- Durable TP-X® palm
- Elastic cuff with Velcro® closure

3092

Article No. 60010

ThornArmor 3092

- Three layers of SuperFabric®** brand material in the palm and partial index finger wrap provides industry-leading cut resistance (interior layer)
- Breathable HexVent® panel on the back-of-hand helps keep you cool
- Airprene cuff with Velcro® closure for a secure fit
- Durable TP-X® palm provides superior grip and abrasion resistance

AG10009S

Article No. 60985

Arm Guard AG10009S

- The SuperFabric® brand material provides industry-leading cut resistance
- Industrial puncture protection in exposed areas to help protect against injuries caused by cables, metal, wood and glass
- Elastane insert on wrist with thumb hole

	Chrome 4023M
Article No.	60673
Standard	EN 388: 2016 (4 X 4 1 F)
Colour	grey/green
Sizes	7/S through 12/3XL
Order quantity multiples	1 PR

	HexArmor ThornArmor 3092
Article No.	60010
Standard	EN 388: 2016 (4 X 3 3 F)
Colour	brown/black
Sizes	5/XXS through 11/2XL
Order quantity multiples	1 PR

	Arm Guard AG10009S
Article No.	60985
Standard	EN 388: 2016 (4 X 4 2 F)
Colour	black/neon-yellow
Sizes	6/XS through 12/3XL
Order quantity multiples	1 PC

Cut protection Series/Impact Series





60609



60984





60646

 SuperFabric® Protection Zone
 HPPE Blend Shell

ANSI/ISEA CUT	GRAM SCORE	ANSI/ISEA PUNCTURE
A8	5022	4

 EN 388:2016
4 X 4 3 F





 Impact Protection
 HPPE Blend Shell

ANSI/ISEA CUT	GRAM SCORE	ANSI/ISEA PUNCTURE
A6	3685	2

 EN 388:2016
4 X 4 1 F P

 ANSI/ISEA 138
1





 Impact Protection
 Acrylic Blend Shell

ANSI/ISEA CUT	GRAM SCORE
A6	3132

 EN 511
1 2 X

 EN 388:2016
4 X 4 3 E P

 ANSI/ISEA 138
1



9013

Article No. 60984

9000 Series 9013

- SuperFabric® brand materials provide industry-leading cut resistance (interior layer)
- HPPE and fiberglass blend shell
- Abrasion-resistant sandy nitrile palm coating

4070

Article No. 60609

Chrome SLT 4070

- HPPE blend liner provides 360° industry-leading cut resistance (interior layer)
- Back-of-hand impact guards provide ANSI/ISEA 138 Level 1 protection on knuckles and fingers
- Synthetic leather palm with abrasion-resistant PVC dots
- Hi-vis color on back-of-hand
- Elastic cuff with Velcro® closure for a secure fit, Pull tab

2099

Article No. 60646

Thin Lizzie™ Thermal

- Back-of-hand IR-X® Impact Exoskeleton™ with high-flex design provides ANSI/ISEA 138 Level 2 protection on knuckles and Level 1 protection on fingers
- 13-gauge acrylic and fiberglass blend shell offers 360° cut resistance
- Sandy nitrile full coating provides superior grip
- Full double-dipped coating offers liquid resistance
- Interior fleece lining for warmth

9000 Series 9013	
Article No.	60984
Standard	EN 388: 2016 (4 X 4 3 F)
Colour	mottled grey/black
Sizes	7/S through 11/2XL
Order quantity multiples	1 PR

Chrome SLT 4070	
Article No.	60609
Standard	EN 388: 2016 (4 X 4 1 F P)
Colour	orange/grey
Sizes	6/XS through 12/3XL
Order quantity multiples	1 PR

Thin Lizzie™ Thermal 2099	
Article No.	60646
Standard	EN 388: 2016 (4 X 4 3 E P), EN 511 (1 2 X)
Colour	yellow/black/red
Sizes	6/XS through 11/XXL
Order quantity multiples	1 PR

Impact Series



60642



60652



60651

EN 388:2016
4 1 2 1 X P

Impact Protection	ANSI/ISEA CUT	GRAM SCORE	ANSI/ISEA PUNCTURE
Nylon Blend Shell	A1	255	2
	ANSI/ISEA 138		
	1		

EN 388:2016
4 1 2 1 X P

Impact Protection	ANSI/ISEA CUT	GRAM SCORE	ANSI/ISEA PUNCTURE
HPPE Blend Shell	A1	257	2
	ANSI/ISEA 138		
	1		

EN 388:2016
4 X 4 2 C P

Impact Protection	ANSI/ISEA CUT	GRAM SCORE	ANSI/ISEA PUNCTURE
HPPE Blend Shell	A4	1274	3
	ANSI/ISEA 138		
	1		

1095

Article No. 60642

Helix®

- High-performance 15-gauge nylon blend shell
- Flexible sandy nitrile palm coating
- Back-of-hand IR-X® Impact Exoskeleton™ with high-flex design provides ANSI/ISEA 138 Level 1 protection on knuckles and fingers

7101

Article No. 60651

Rig Lizard 7101

- Back-of-hand IR-X® Impact Exoskeleton™ with high-flex design provides ANSI/ISEA 138 Level 2 protection on knuckles and Level 1 protection on fingers
- Sandy nitrile full coating provides superior grip and abrasion resistance
- Full double dip for fluid/water resistance

7102

Article No. 60652

Thin Lizzie™ Fluid

- Back-of-hand IR-X® Impact Exoskeleton™ with high-flex design provides ANSI/ISEA 138 Level 2 protection on knuckles and Level 1 protection on fingers
- 13-gauge HPPE and fiberglass blend shell
- Sandy nitrile full coating
- Full double-dipped coating offers liquid resistance

	Helix® 1095
Article No.	60642
Standard	EN 388: 2016 (4 1 2 1 X P)
Colour	grey/black/yellow
Sizes	6/XS through 12/3XL
Order quantity multiples	1 PR

	Rig Lizard 7101
Article No.	60651
Standard	EN 388: 2016 (4 1 2 1 X P)
Colour	yellow/blue
Sizes	6/XS through 12/3XL
Order quantity multiples	1 PR

	Thin Lizzie™ Fluid 7102
Article No.	60652
Standard	EN 388: 2016 (4 X 4 2 C P)
Colour	blue/yellow
Sizes	6/XS through 12/3XL
Order quantity multiples	1 PR

Impact Series



60665



60666



60662

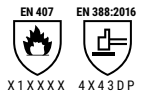
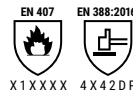

Impact Protection
HPPE Blend Shell

ANSI/ISEA PUNCTURE 3

Impact Protection
HPPE Blend Shell

ANSI/ISEA PUNCTURE 3

Impact Protection
HPPE Blend Shell

ANSI/ISEA PUNCTURE 3



3000

Article No. 60662

Helix®

- 13-gauge HPPE and fiberglass shell
- Flexible sandy nitrile palm coating
- Back-of-hand IR-X® Impact Exoskeleton™ with high-flex design
- Reinforced thumb crotch patch

3003

Article No. 60665

Helix®

- 13-gauge HPPE and steel shell
- Flexible sandy nitrile palm coating
- Back-of-hand IR-X® Impact Exoskeleton™ with high-flex design
- Reinforced thumb crotch patch
- Elastic cuff with Velcro® closure

3007

Article No. 60666

Helix®

- IR-X® Impact Exoskeleton™ with high-flex de
- velcro closure for a good fitting
- High-performance polyethylene and glass fiber
- exceptional dexterity and feel
- Reinforced thumb crotch patch
- Sandy nitrile palm coating

Helix® 3000	
Article No.	60662
Standard	EN 388: 2016 (4 X 4 2 D P)
Colour	yellow/black
Sizes	6/XS through 12/3XL
Order quantity multiples	1 PR

Helix® 3003	
Article No.	60665
Standard	EN 388: 2016 (4X42DP), EN 407 (X1XXXX)
Colour	black/black
Sizes	7/S through 11/XXL
Order quantity multiples	1 PR

Helix® 3007	
Article No.	60666
Standard	EN 388: 2016 (4X43DP), EN 407 (X1XXXX)
Colour	red/yellow/black/grey
Sizes	6/XS through 12/3XL
Order quantity multiples	1 PR

Impact Series



60648



60681



60650

EN 388:2016
4 X 4 4 E P

Impact Protection
HPPE Blend Shell

ANSI/ISEA CUT
A4

GRAM SCORE
2053

ANSI/ISEA PUNCTURE
5

ANSI/ISEA 138
1

EN 388:2016
4 X 4 4 F P

Impact Protection
HPPE Blend Shell

ANSI/ISEA CUT
A6

GRAM SCORE
3276

ANSI/ISEA PUNCTURE
5

ANSI/ISEA 138
2

EN 407
X2 XXXX

EN 388:2016
4 X 4 3 B P

Impact Protection
TP-X® Technology

ANSI/ISEA CUT
A2

GRAM SCORE
791

ANSI/ISEA PUNCTURE
4

ANSI/ISEA 138
2

2090X

Article No. 60648

Thin Lizzie™

- Back-of-hand IR-X® Impact Exoskeleton™ with high-flex design provides ANSI/ISEA 138 Level 2 protection on knuckles and Level 1 protection on fingers
- 13-gauge HPPE and glass fiber blend shell provides exceptional dexterity and feel
- Sandy nitrile palm coating
- Reinforced thumb crotch patch
- Protected by U.S. Patent No. D703,389

Thin Lizzie™ 2090X	
Article No.	60648
Standard	EN 388: 2016 (4 X 4 4 E P)
Colour	grey/yellow
Sizes	5/XXS through 12/3XL
Order quantity multiples	1 PR

2095

Article No. 60650

Thin Lizzie™

- Back-of-hand IR-X® Impact Exoskeleton™ with high-flex design provides ANSI/ISEA 138 Level 2 protection on knuckles and Level 1 protection on fingers
- 13-gauge HPPE, steel, and fiberglass blend shell
- Polyurethane palm coating
- Reinforced thumb crotch patch

Thin Lizzie™ 2095	
Article No.	60650
Standard	EN 388: 2016 (4 X 4 4 F P)
Colour	blue/black/yellow
Sizes	5/XXS through 12/3XL
Order quantity multiples	1 PR

2038

Article No. 60681

Rig Lizard 2038

- Back-of-hand sewn-on IR-X® Impact Exoskeleton™ with high-flex design provides ANSI/ISEA 138 Level 2 protection on knuckles and fingers
- Reinforced TP-X® index finger and thumb saddle
- MudGrip+ palm: Synthetic leather with abrasion resistant PVC dots
- Elastic cuff with Velcro® closure for a secure fit, Pull tab loop

Rig Lizard 2038	
Article No.	60681
Standard	EN 388: 2016 (4 X 4 3 B P), 407 (X2 XXXX)
Colour	red/yellow
Sizes	6/XS through 12/3XL
Order quantity multiples	1 PR

Impact Series



60682



60670



60986

	X 2 X X X X	4 X 4 3 C P	
	ANSI/ISEA CUT		
	A3	GRAM SCORE	ANSI/ISEA PUNCTURE
		1074	4
	ANSI/ISEA 138		
	2		

	X 2 X X X X	4 X 4 3 E P	
	ANSI/ISEA CUT		
	A6	GRAM SCORE	ANSI/ISEA PUNCTURE
		3472	4
	ANSI/ISEA 138		
	2		

	4 X 2 1 F P	
	ANSI/ISEA CUT	
	A8	GRAM SCORE
		5486
	ANSI/ISEA PUNCTURE	
	2	

2021X

Article No. 60670

Rig Lizard®

- Back-of-hand IR-X® Impact Exoskeleton™ with high-flex design provides ANSI/ISEA 138 Level 1 protection on knuckles and fingers
- Additional IR-X® guard between thumb and index finger
- Durable TP-X® palm with reinforced stitching
- SlipFit® cuff with pull tab
- Protected by patents and patents pending

	Rig Lizard® 2021X
Article No.	60670
Standard	EN 388:2016 (4 X 4 3 C P), EN 407 (X 2 X X X X)
Colour	yellow/black/red
Sizes	6/XS through 12/3XL
Order quantity multiples	1 PR

2039

Article No. 60682

Rig Lizard 2039

- Back-of-hand sewn-on IR-X® Impact Exoskeleton™ with high-flex design provides ANSI/ISEA 138 Level 2 protection on knuckles and fingers
- Reinforced TP-X® index finger and thumb saddle
- MudGrip+ palm: Synthetic leather with abrasion resistant PVC dots
- Elastic cuff with Velcro® closure for a secure fit, Pull tab loop

	Rig Lizard 2039
Article No.	60682
Standard	EN 388:2016 (4 X 4 3 E P), 407 (X 2 X X X X)
Colour	red/yellow
Sizes	6/XS through 12/3XL
Order quantity multiples	1 PR

4026

Artikel-Nr: 60986

Chrome 4026

- SuperFabric® brand materials provide industry-leading cut resistance (interior layer)
- Back-of-hand impact guards provide ANSI/ISEA 138 Level 1 protection on knuckles and fingers
- Synthetic leather palm with abrasion-resistant PVC dots
- Hi-vis color and reflective tape on back-of-hand
- Elastic cuff with Velcro® closure for a secure fit

	Chrome 4026
Article No.	60986
Standard	EN 388:2016 (4 X 2 1 F P)
Colour	black/neon-yellow
Sizes	6/XS through 12/3XL
Order quantity multiples	1 PR



Safety Gloves

Overview

Art. no.	Art. code	Sizes	Colour	Page
60027	uvex athletic lite	6 to 11	blue, anthracite	206
60028	uvex athletic allround	6 to 11	grey, anthracite	205
60030	uvex athletic D5 XP	6 to 11	grey, anthracite	227
60033	uvex athletic lite dry	6 to 12	blue, anthracite	206
60036	uvex athletic B XP	6 to 12	grey, anthracite	226
60037	uvex athletic C XP	6 to 12	grey, anthracite	226
60038	uvex phynomic airLite A ESD	6 to 12	black	200
60040	uvex phynomic lite	5 to 12	grey, grey	204
60041	uvex phynomic lite w	5 to 12	white, white	204
60049	uvex phynomic allround	5 to 12	grey, black	201
60050	uvex phynomic foam	5 to 12	white, grey	201
60054	uvex phynomic x-foam HV	6 to 12	orange, grey	202
60060	uvex phynomic wet	6 to 12	blue, anthracite	202
60061	uvex phynomic wet plus	6 to 12	blue, anthracite	202
60062	uvex phynomic pro	6 to 12	blue, anthracite	203
60064	uvex phynomic pro 2	6 to 12	blue, anthracite	203
60070	uvex phynomic XG	6 to 12	black, black	201
60078	uvex phynomic airLite B ESD	6 to 12	light blue	224
60080	uvex phynomic C3	6 to 12	sky blue	225
60081	uvex phynomic C5	6 to 12	blue, grey	225
60084	uvex phynomic airLite C ESD	6 to 12	light blue	225
60090	uvex BambooTwinflex®	6 to 12	green, black	219
60119	uvex profapren CF33	7 to 10	dark blue	239
60122	uvex profastrong NF33	7 to 11	green	239
60135	uvex unigrip 6620	7 to 10	white, blue	209
60147	uvex profi ergo ENB20A	6 to 11	white, orange	210
60148	uvex profi ergo ENB20	6 to 10	white, orange	210
60150	uvex contact ergo	6 to 10	white, orange	210
60179	uvex k-basic extra 6658	8, 10, 12	yellow	241
60166	uvex u-fit ft	XS to XL	blue	213
60188	uvex u-chem 3500	7 to 11	orange	235
60190	uvex rubiflex S NB80S	9 to 11	green	232
60191	uvex rubiflex S NB80SZ	9 to 11	green	232
60202	uvex NK4022	9 to 10	orange	213
60208	uvex profi ergo XG20	6 to 11	white, orange, black	211
60210	uvex unidur 6641	6 to 11	white, grey	228
60213	uvex NK2722	9 to 10	orange	213
60224	uvex rubiflex S NB35B	7 to 11	blue	233
60238	uvex unigrip 6624	7 to 10	grey, red	209
60248	uvex unipur 6639	6 to 11	black, black	208
60271	uvex rubiflex S NB27B	7 to 11	blue	233
60276	uvex rubipor XS2001	6 to 10	white, white	205
60278	uvex unilite 7710F	-	black	212
60314	uvex unidur 6643	7 to 10	mottled grey, black	229
60316	uvex rubipor XS5001B	6 to 10	white, blue	205
60321	uvex unipur 6634	7 to 10	grey, black	207
6047900	uvex glove clip	-	black	211
60491	uvex C500 sleeve	M, L	lime	221
60492	uvex C500 wet	7 to 11	lime, anthracite	222
60494	uvex C500 foam	7 to 11	lime, anthracite	222
60496	uvex C500 wet plus	7 to 11	lime, anthracite	221
60497	uvex C500	7 to 11	lime	221
60498	uvex C500 M foam	7 to 11	lime, black, anthracite	220
60499	uvex C500 dry	7 to 11	lime, anthracite	222
60516	uvex unidur 6649	7 to 11	mottled grey, grey	228
60535	uvex protector chemical NK2725B	9 to 10	blue	238
60536	uvex protector chemical NK4025B	9 to 10	blue	238
60542	uvex C300 wet	7 to 11	anthracite	223
60544	uvex C300 foam	7 to 11	anthracite	223
60549	uvex C300 dry	7 to 11	anthracite	223
60556	uvex unipur carbon	6 to 10	grey	209
60557	uvex rubiflex S XG35B	7 to 11	blue, black	233
60558	uvex profi ergo XG20A	6 to 11	white, orange, black	211
60560	uvex rubiflex S XG27B	7 to 11	blue, black	233
60573	uvex unilite 6605	6 to 11	black, black	207
60585	uvex unilite 7700	7 to 11	grey, black	207
60587	uvex unipur carbon FT	6 to 10	grey	209
60591	uvex unilite thermo plus cut C	7 to 11	lime, black	214
60592	uvex unilite thermo plus	7 to 11	black	214
60593	uvex unilite thermo	7 to 11	black	214

Art. no.	Art. code	Sizes	Colour	Page
60595	uvex profatherm XB40	11	white	213
60596	uvex u-fit	S to XL	blue	241
60597	uvex u-fit lite	S to XL	indigo blue	241
60600	uvex C500 XG	7 to 11	lime, anthracite	221
60604	uvex D500 foam	7 to 11	lime, anthracite	220
60838	uvex arc protect g1	7 to 11	anthracite	215
60840	uvex power protect V1000	7 to 11	red	215
60932	uvex unidur 6648	6 to 11	white, black	228
60938	uvex unidur 6659 foam	6 to 11	mottled grey, black	229
60942	uvex unilite thermo HD	8 to 11	orange, black	214
60943	uvex unipur 6630	6 to 11	white	208
60944	uvex unipur 6631	6 to 11	grey	208
60945	uvex compact NB27H	10	white, blue	212
60946	uvex compact NB27E	9 to 10	white, blue	212
60949	uvex profabutyl B-05R	7 to 11	black	237
60954	uvex rubiflex ESD NB35A	6 to 11	black	236
60957	uvex profaviton BV-06	8 to 11	black	237
60962	uvex u-strong N2000	S to XXL	blue	241
60968	uvex u-chem 3100	8 to 11	black	234
60971	uvex u-chem 3300	7 to 11	blue	234
60972	uvex u-chem 3200	7 to 11	petrol, black	234
60973	uvex unidur sleeve C	M, L	mottled grey	227
60974	uvex unidur sleeve C TL	M, L	mottled grey	227
89636	uvex rubiflex NB27	7 to 11	orange	212
89646	uvex rubiflex S NB27S	8 to 11	green	232
89647	uvex rubiflex S NB60S	9 to 11	green	232
89651	uvex rubiflex S NB60SZ	9 to 11	green	232
98891	uvex rubiflex S NB35S	8 to 11	green	232
98902	uvex rubiflex S NB40S	8 to 11	green	232



Art. no.	Art. code	Sizes	Colour	Page
60005	PointGuard® Ultra 90931	6 to 12	black	247
60010	ThornArmor 3092	5 to 11	brown/black	250
60609	Chrome SLT 4070	6 to 12	orange/grey	251
60614	Helix® 2082	7 to 11	green mottled/black	248
60638	PointGuard® Ultra 9032	7 to 10	yellow/blue	246
60642	Helix® 1095	6 to 12	grey/black/yellow	252
60646	Thin Lizzie™ Thermal 2099	6 to 10	yellow/black/red	251
60648	Thin Lizzie™ 2090X	5 to 12	grey/yellow	254
60650	Thin Lizzie™ 2095	5 to 12	blue/black/yellow	254
60651	Rig Lizard 7101	6 to 12	yellow/blue	252
60652	Thin Lizzie™ Fluid 7102	6 to 12	blue/yellow	252
60655	Chrome SLT® 4062	6 to 12	beige	249
60659	Helix® 2065	6 to 12	blue/black	248
60660	Helix® 2076	5 to 13	blue mottled/black	248
60661	Helix® 2062	6 to 12	yellow/black	249
60662	Helix® 3000	6 to 12	yellow/black	253
60665	Helix® 3003	7 to 10	black/black	253
60666	Helix® 3007	6 to 12	red/yellow/black/grey	253
60668	Helix® 3033	6 to 11	mottled blue	249
60670	Rig Lizard® 2021X	6 to 12	yellow/black/red	255
60672	PointGuard® Ultra 4043U	7 to 10	black	247
60673	Chrome 4023M	7 to 12	grey/green	250
60681	Rig Lizard 2038	6 to 12	red/yellow	254
60682	Rig Lizard 2039	6 to 12	red/yellow	255
60981	SharpsMaster II® 9014	6 to 10	white/orange	246
60982	Armschutz AG8TW	7 to 10	black	246
60983	Hercules® NSR 3041	7 to 11	black	247
60984	9000 Series 9013	7 to 11	mottled grey/black	251
60985	Armschutz AG10009S	6 to 12	black/neon-yellow	250
60986	Chrome 4026	6 to 12	black/neon-yellow	255



Safety Footwear



protecting planet

To help raise awareness of its commitment to achieving increased sustainability, uvex has developed the **protecting planet** icon.

For uvex, **protecting planet** is more than a label. Based on the brand claim, **protecting people**, our sustainable approach integrates three core interlinked pillars – **ecology, economy** and **social responsibility**, that are incorporated throughout the business to improve our sustainability performance.

This explains the comprehensive audit, measurement and evaluation management process uvex undertakes along the entire value chain to ensure its products are as sustainable as possible.



uvex 1 G2 planet

The **uvex 1 G2 planet** is an example of the **planet series** product system.



protecting planet

by using bio-based material //
by using recycled material //
by maximum reduction of pollutants

The upper part of the safety shoe is made from 100 percent recycled polyester made from PET bottles. The penetration resistant midsole is also made from 100 percent recycled materials. 40 percent recycled TPU is used for the TPR scuffcap. The shoe's distance mesh lining is made from 52 percent recycled polyester and 18 percent bamboo fibres. The replaceable comfortable climatic insole is also made of 100 percent recycled PU foam and polyester. The entire safety shoe is manufactured free from harmful substances according to the restricted substances list created by uvex, which goes beyond REACH.



protecting planet

by using environmentally-friendly packaging

All uvex shoe boxes are made from 90 percent recycled cardboard. 100 percent recycled tissue paper is used and the instructions for use are also made of 100 percent recycled paper.



protecting planet

by reducing waste //
by reducing CO₂ emissions

The uvex plant in Ceva, Italy, was already completely converted to green electricity and green gas a few years ago and has been certified according to the environmental management system ISO 14001 since 2017. In addition, the plant uses renewable energy with a photovoltaic system. uvex places a special focus on waste prevention. For example, some years ago, the shape of the soles were redesigned, which as a result significantly reduced the amount of waste. The cleaning and injection process is also continuously optimised. For some time now, all PU waste is collected and processed into granules ready for reuse. Up to 10 percent recycled PU waste from uvex's production is used for the TPU outsole of the uvex 1 G2 planet.



Safety footwear for the highest demands

uvex safety footwear competence center



Innovation:

One of the most state-of-the-art production facilities in Europe

Laser roughing cell provides excellent-quality rough contours for optimal sole adhesion.

 **uvex competence center for safety footwear in Ceva (CN), Italy**

Development expertise, state-of-the-art robot-controlled production systems and optimised process structures to meet the highest ecological standards guarantee the first-class and sustainable quality of our safety shoes.

The production in Italy, which is one of the most modern production facilities for safety shoes in Europe, ensures efficient, resource-saving production and short distances from manufacturer to user.

 **Expertise**

- production of direct-injected safety shoes with outsoles made of polyurethane, thermoplastic polyurethane and rubber
- innovative production technologies, e.g. for using rebound properties
- four DESMA direct-injection machines for producing uvex outsoles, with DESMA AMIR system (automated material handling with integrated robots)
- extensively equipped test laboratory for quality and production assurance and for product development

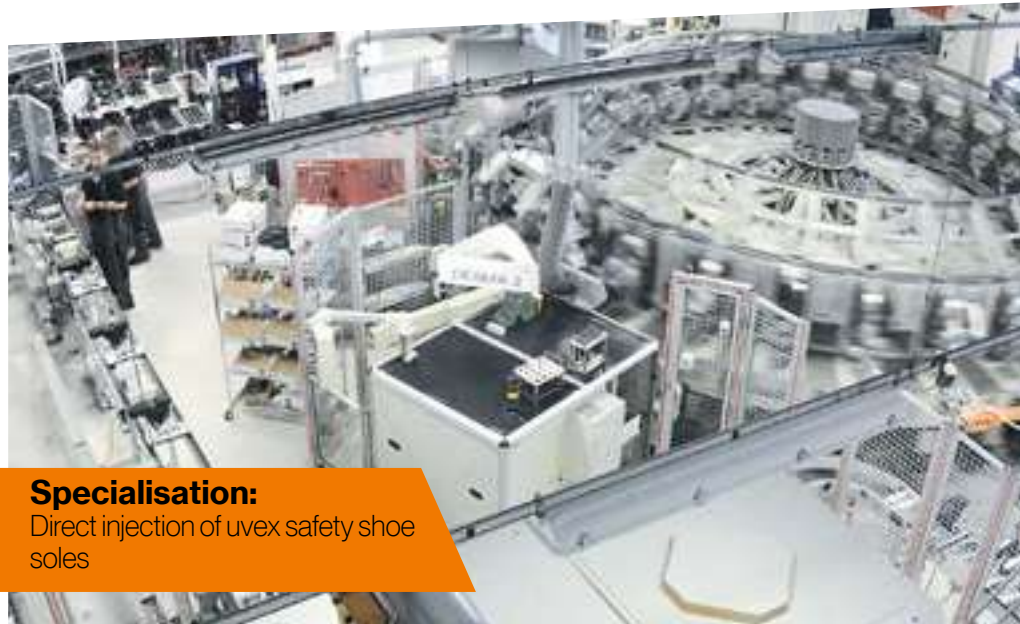

Specialisation:

Direct injection of uvex safety shoe soles

Made in uvex
Made in Italy

Sustainability

- uses 100% green energy and green gas
- uses environmentally friendly solar energy (photovoltaic system installed since 2011)
- PUR waste management for recycling and saving polyurethane waste
- uses water-based release agents (numerous approvals in the automotive and supplier industries)

Certifications

- ISO 9001-certified quality management system (since 2003)
- ISO 14001-certified environmental management system (since 2017, first certificate in the uvex safety group)
- ISO 45001-certified occupational health and safety management system (since 2020, replacement for OHSAS 18001 certification)

Expertise at uvex headquarters in Fürth, Germany

- product design and development
- biomechanics
- model building and prototyping
- quality and international manufacturing support
- supply chain management
- commercial processing
- process engineering
- training, product management and marketing

Responsibility:

Uses renewable energy and CO₂-neutral electricity and gas



Safety Footwear

Areas of application: light · medium · heavy



light
areas of application

'Light' covers all areas of application where work is primarily carried out indoors and without significant demands on the physical properties of the outsole. Examples include assembly workplaces, as well as storage and logistics areas.



medium
areas of application

'Medium' applications usually take place both indoors and outdoors, with the outsole needing to be significantly more robust. Typical users include manual labourers, public sector employees and people working in the chemical industry.



heavy
areas of application

'Heavy' applications involve external influences that place extensive demands on the shoe, its durability and stability. They are usually found in heavy mechanical engineering and in the construction industry, especially in building and civil engineering.

Safety Footwear

uvex multiple fit system

uvex multiple fit system

As part of the safety footwear multiple fit system, a footwear style is offered in the same size but in a range of different fits. The different fits are based on the measurement of the widest part of the foot. While the foot is under load, a measurement is taken of either the circumference of the foot at the base joint of the big toe and the base joint of the little toe, or alternatively the width of the foot at this point (see opposite).

The classification of sizes and the corresponding values are detailed in the table below (all measurements in mm):

uvex shoe size	Foot length	UK size	Width 10	Width 11 (standard)	Width 12	Width 14
35	210-217	3	216.5	222.5	228.5	240.5
36	218-225	3.5	221	227	233	245
37	226-232	4	225.5	231.5	237.5	249.5
38	233-240	5	230	236	242	254
39	241-247	6	234.5	240.5	246.5	258.5
40	248-255	6.5	239	245	251	263
41	256-262	7	243.5	249.5	255.5	267.5
42	263-270	8	248	254	260	272
43	271-277	9	252.5	258.5	264.5	276.5
44	278-285	10	257	263	269	281
45	286-292	10.5	261.5	267.5	273.5	285.5
46	293-300	11	266	272	278	290
47	301-307	12	270.5	276.5	282.5	294.5
48	308-315	13	275	281	287	299
49	316-322	14	279.5	285.5	291.5	303.5
50	323-330	14.5	284	290	296	308
51	331-337	15	288.5	294.5	300.5	312.5
52	338-345	16	293	299	305	317

All measurements in mm.

Anatomical circumference of the foot

Base joint of the big toe

Base joint of the little toe

The required width can be determined from the table according to the wearer's foot length.

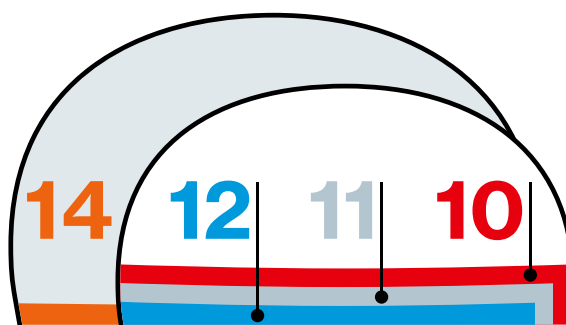

uvex fit advisor app

- User-friendly operation
- Automatic foot recognition
- Size and width recommendation
- Shoe recommendation based on the area of application
- Filter options in the footwear advisor



Find out how it works



Safety Footwear

Pictogram overview

clima zone

uvex climazone

uvex climazone is an innovative head-to-toe climate control system. uvex has combined its expertise in research and product development with the use of intelligent materials and processing technologies to develop a unique range of climate-optimising safety products, such as safety footwear.

bionom x

uvex bionom x

uvex has created a unique approach to the design of safety shoes that is based on biomechanics. This is reflected in visible common lines that optimise the foot-upper-sole-ground interaction and provide extraordinary performance and comfort across all applications.



ESD

ESD indicates the controlled discharge of electrostatic energy that can cause damage to electronic components in the event of uncontrolled discharge or trigger explosions. Safety footwear marked with the ESD symbol meets the ESD specification with a volume resistance of less than 35 megaohms. For a detailed explanation, see page 267.



Silicone-free

Certain materials such as silicones, plasticisers and similar substances can impair the lacquer wetting of surfaces. The sole materials of footwear with this symbol has been tested accordingly by the automotive industry and approved.

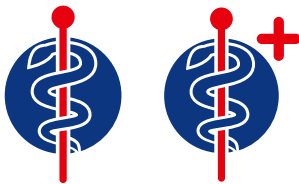

uvex medicare

uvex medicare designates safety footwear that has been certified for orthopaedic adjustment and orthopaedic shoes in accordance with EN ISO 20345:2022, German Institute for Occupational Health and Safety (DGUV) regulation 112-191 and/or Austrian ÖNORM Z 1259.

uvex medicare logo = certified for orthopaedic insoles

uvex medicare + logo = certified for orthopaedic insoles and shoe adjustments



uvex construction

Especially suited to applications in the construction industry



uvex women's and men's last

To ensure a proper fit for both men and women the last should vary according to the intended gender. Safety footwear marked with these symbols have been produced in sizes 35-40 using a last which mimics the contours of the female foot.



The BOA® Fit System.

Delivering fit solutions purpose-built for performance, the BOA® Fit System is featured in products across industries (in medical, sports and workwear) and consists of three integral parts: a micro-adjustable dial, a super-strong lightweight lace and low friction lace guides.

The BOA® benefits.

Fit to perform.

Dial in your precise fit quickly and effortlessly. Even micro adjustments can be made quickly and easily on the fly, so you can always get the job done.

Confidence in all conditions.

The BOA® Fit System is extremely robust and has been tested under the toughest conditions. It will work as hard as you do so you can stay focused and confident in any environment - without ever having to remove your gloves.



Stay secure and focused.

BOA®'s precision engineered laces stay contained in the dial cartridge, out our your way and out of machinery.

Fit for life with BOA®.

The BOA® Fit System dials and laces are guaranteed for the lifetime of the product on which they are integrated.

How it works.

-  push in to engage
-  turn to tighten
-  pull up for quick release



sympatex®

Excellent comfort whatever the weather: waterproof, breathable, windproof

There is nothing more unpleasant than wet and cold clothing and shoes. Sympatex has therefore developed a special membrane which absorbs the water vapour and removes it to the outside. This keeps the foot warm and dry even in extreme situations.

And the best thing about it is that the higher the physical activity, the more efficient the sympatex membrane works. Shoes with a sympatex membrane also provide effective protection from low temperatures and rain.

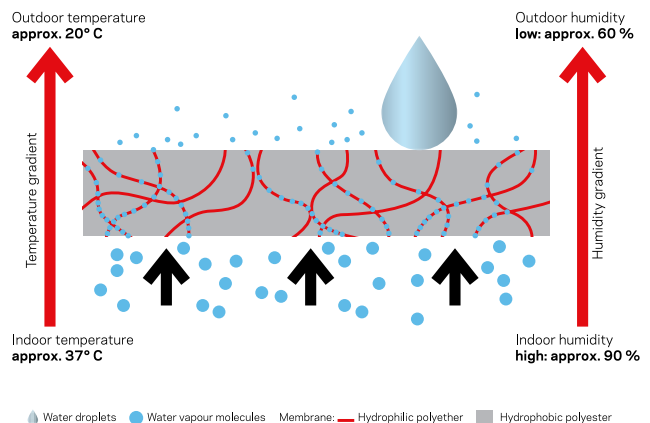

-  100% WATERPROOF
-  100% WINDPROOF
-  OPTIMALLY BREATHABLE
-  DURABLE
-  RECYCLABLE & RECYCLED
-  PFC-FREE
-  PTFE-FREE
-  CO2 NEUTRAL



www.sympatex.com

Safety Footwear

Standards · Labels

Labelling

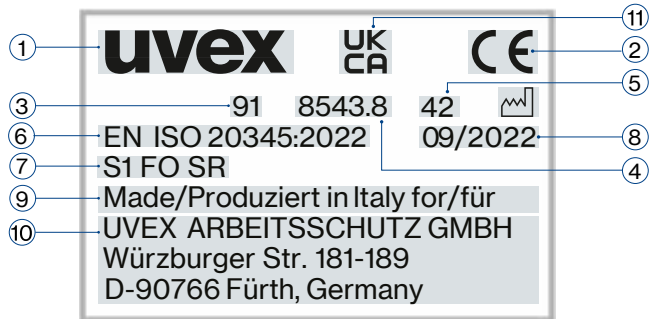

The labelling on the shoe contains the following information

- ① Manufacturer
- ② CE symbol
- ③ Manufacturer's type designation
- ④ Article number
- ⑤ Size
- ⑥ Number of European standard
- ⑦ Symbol for protection
- ⑧ Date of manufacture
- ⑨ Country of Manufacture
- ⑩ Postal address of the manufacturer
- ⑪ UKCA symbol

Basic and additional requirements for safety shoes (in accordance with EN ISO 20345:2022, marking S) and occupational shoes (in accordance with EN ISO 20347:2022, marking O)

Symbol	Requirement	Category													
		SB	S1	S2	S3	S3L	S3S	S5	S6	S7	S7L	S7S	O1	O2	
-	Basic requirements	X	X	X	X	X	X	X	X	X	X	X	X	X	
-	Toe cap, tested via 200 joule drop test and 15 kilonewton pressure test	X	X	X	X	X	X	X	X	X	X	X	-	-	
-	Footwear made of leather or other materials, not including solid rubber or total polymers	O	X	X	X	X	X	-	X	X	X	X	X	X	
-	Footwear made of solid rubber or total polymers	O	-	-	-	-	-	X	-	-	-	-	-		
-	Slip resistance on ceramic tile floors with SLS	X	X	X	X	X	X	X	X	X	X	X	X	X	
-	Closed seat region	O	X	X	X	X	X	X	X	X	X	X	X	X	
A	Antistatic footwear	O	X	X	X	X	X	X	X	X	X	X	X	X	
E	Energy absorption of seat region	O	X	X	X	X	X	X	X	X	X	X	X	X	
WPA	Water penetration and absorption of upper material	O	-	X	X	X	X	-	X	X	X	X	-	X	
WR	Whole shoe waterproof	O	O	O	O	O	O	-	X	X	X	X	O	O	
P	Perforation resistance, metallic insert	O	O	O	X	-	-	X	O	X	-	-	O	O	
PL	Perforation resistance, non-metallic insert, tested with a 4.5 mm test nail	O	O	O	-	X	-	-	O	-	X	-	O	O	
PS	Perforation resistance, non-metallic insert, tested with a 3.0 mm test nail	O	O	O	-	-	X	-	O	-	-	X	O	O	
-	Treaded sole	O	O	O	X	X	X	X	O	X	X	X	O	O	

Additional requirements for special applications

Symbol	Requirement
FO	Fuel resistance and oil resistance
SR	Slip resistance on ceramic tile floors with glycerol
HI	Heat insulation of the sole complex
CI	Cold insulation of the sole complex
HRO	Heat resistance of the outsole
M	Metatarsal protection
AN	Ankle protection
CR	Cut resistance of the upper part of the shoe
SC	Abrasion resistance of optional overcaps
LG	Outsoles provide hold on ladders

X = Requirement must be fulfilled O = Requirement may be fulfilled, but is not mandatory - = Requirement cannot be fulfilled

To ensure optimal clarity, we have included the labelling in accordance with both the old and the new standard in this catalogue. The new labelling on the products will be introduced gradually. The label on your product will help you to identify the version of the standard to which the product is certified.

Safety Footwear

Standards · Labels · ESD

Perforation resistance

The perforation resistance of the footwear has been measured in a laboratory using standardised nails and forces. Nails with a smaller diameter and higher static or dynamic loads increase the risk of perforation. Under these conditions, additional protective measures should be considered. Three generic types of perforation-resistant insoles are currently available for PPE footwear. These include types made of metal materials and of non-metallic materials, which must be chosen by means of an activity-based risk assessment. All types offer protection against perforation risks, but each has different additional advantages or disadvantages, including the following:

Metal (P e.g. S1 P, S3):

Is less affected by the shape of the sharp object/hazard (i.e. diameter, geometry, sharpness) due to the processes used in shoe manufacturing, however, it may not be possible to cover the entire bottom of the foot.

Non-metal (PS or PL or category e.g. S1 PS, S3L):

May be lighter and more flexible and may cover a larger area, but perforation resistance may vary more depending on the shape of the sharp object/hazard (i.e. diameter, geometry, sharpness). In terms of the protection obtained, two types are available. Type PS may offer better protection against objects with a smaller diameter than type PL.

Electrostatic

Controlling unwelcome electrostatic charge is becoming an increasingly important role in industry, as more and more employees come into contact with processes, materials or objects which are sensitive to electrostatic charge. It is often necessary to use safety footwear as part of a system to conduct electrostatic charge in such workplaces.

Independent of various measuring methods, volume resistance between 100 kilohms (1.0×10^5 ohms) and 100 megohms (1×10^8 ohms) is required to fulfil the various relevant standards (e.g. EN ISO 20345, EN 61340).

All ESD-certified products in this catalogue feature the ESD symbol.



These products are also suitable in accordance with the specification for conductive footwear in the German Technical Rules for Hazardous Substances (TRGS) 727 "Avoiding risks of ignition resulting from electrostatic charges."

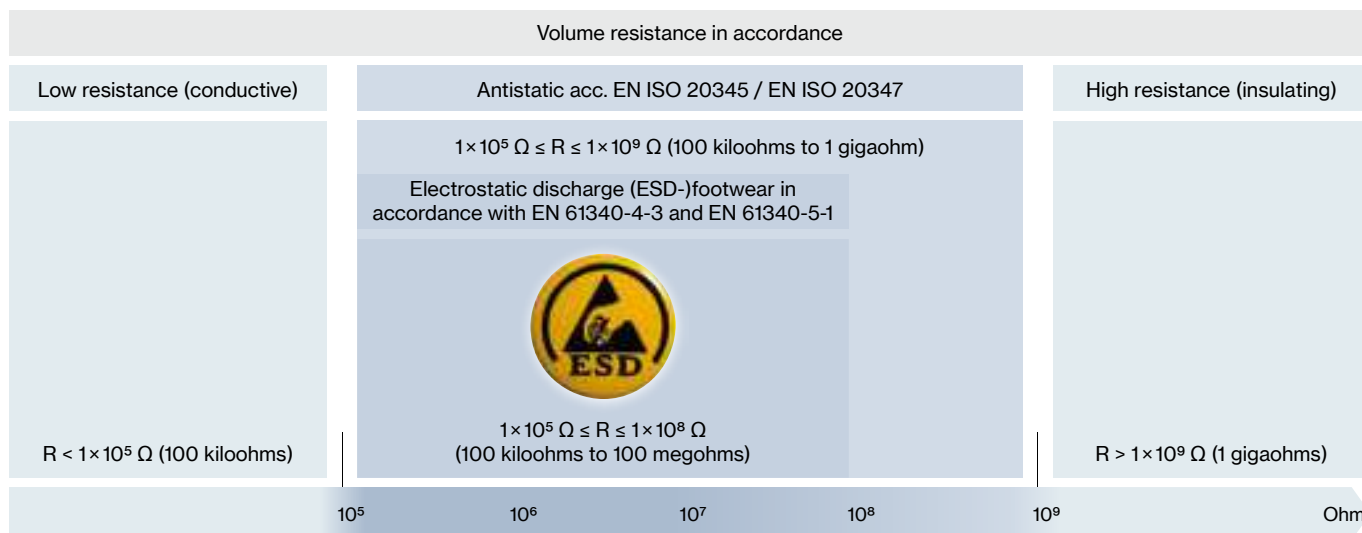

R = electrical resistance



uvex 1 G2 – Science. Not Fiction.

uvex x-dry knit Technology

100% performance. 100% wearer comfort. 100% dry feet. The unique uvex x-dry knit technology offers unparalleled levels of comfort and keeps feet dry: 365 days a year, 7 days a week, 24 hours a day. This is made possible by the intelligent combination of outstanding breathability and the water-repelling characteristics of the innovative uvex x-dry knit upper collar. Hot, sweaty feet are a thing of the past. Independent tests at PFI Pirmasens have proven the unique performance of the uvex x-dry knit technology.

uvex x-tended grip Technology

100% performance. Greater safety and stability. Longer life. The uvex x-tended grip technology, based on the latest-generation TPU outsole, guarantees even greater performance in terms of abrasion resistance of the outsole and slip resistance on smooth or wet surfaces. The result? Greater safety and stability for the wearer when walking. Less wear and consequently lower costs thanks to a longer service life.

Water vapour permeability

40x

better than the minimum requirement of EN ISO 20345

Water vapour coefficient

17x

better than the minimum requirement of EN ISO 20345

Abrasion with uvex x-tended grip

66%

less abrasion than standard

With double load

33%

less abrasion than standard

Water penetration

100%

better than the minimum requirement of EN ISO 20345

Water absorption

10x

better than the minimum requirement of EN ISO 20345

Optimised slip resistance for increased safety

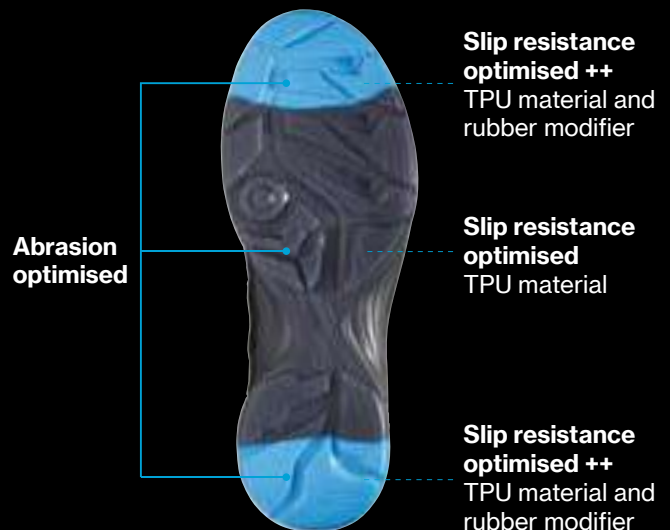

Science. Not Fiction.

uvex i-PUREnrj Technology

Cushioning. Stability. Energy Return.

More stability. Reduced risk of injuries. More safety.

Excellent stability and secure fit in the shoe due to foamed heel basket and adapted density of the uvex i-PUREnrj technology. Reduces risk of injury from twisting through bending over.

Less fatigue. More comfort. More performance.

21%

less perceived fatigue compared to standard polyurethane soles.



You can find more information at www.uvex-safety.com/uvex1G2

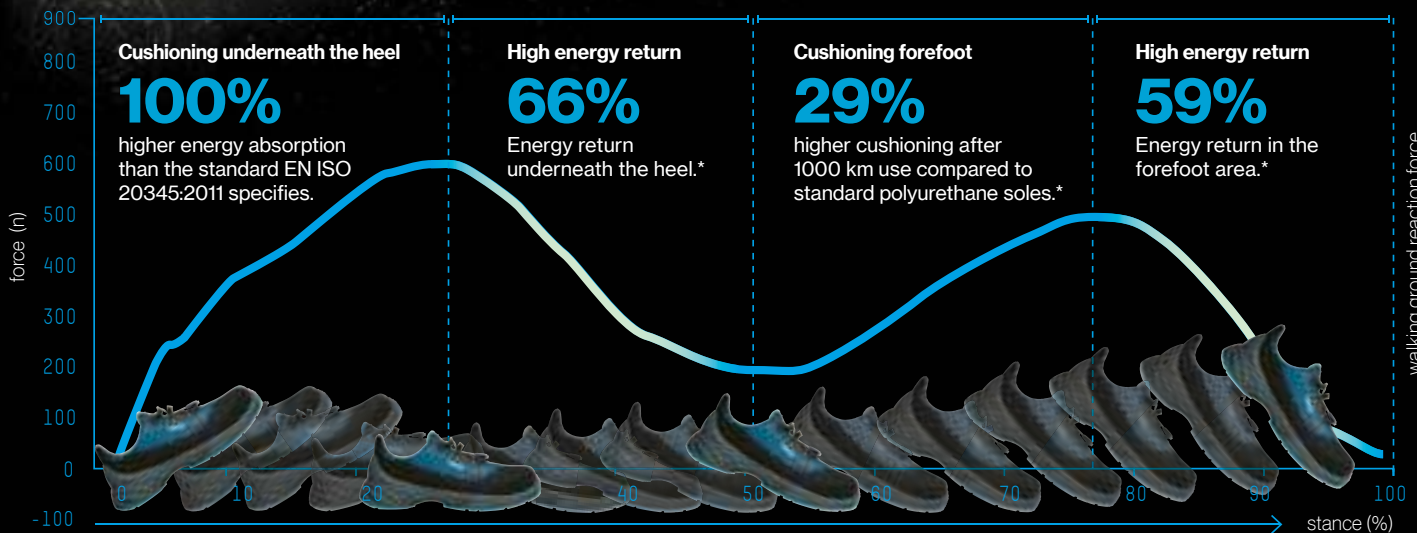

* Marked mentioned results reported in: Nr. L190714889 CTC Lyon, 22.08.2019

uvex 1 G2 planet

100% Performance.
25% recycled.*

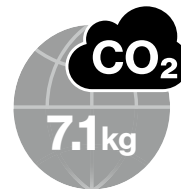
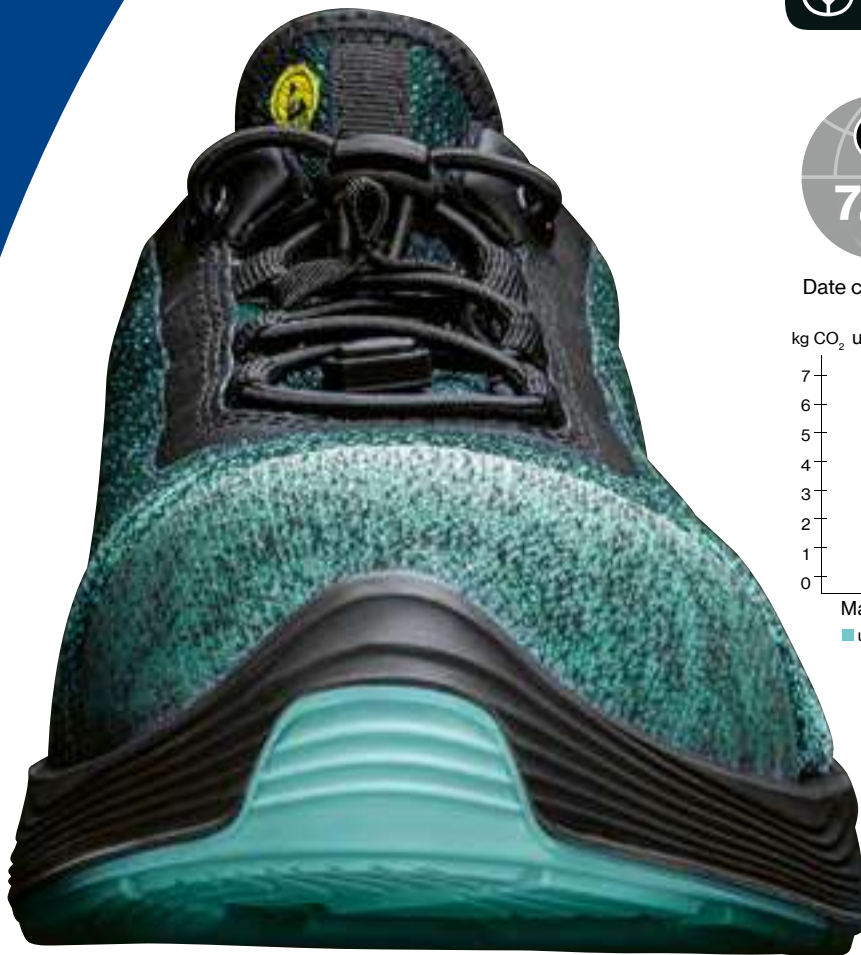

Date created 11/22

kg CO₂ uvex 1 G2 planet and uvex 1 G2 in comparison

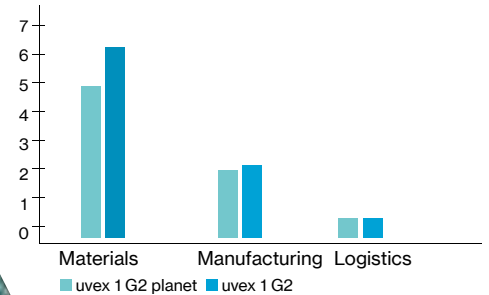

You can find more information at www.uvex-safety.de/uvex1G2planet



For the first time, we have calculated the CO₂ footprint for a uvex safety shoe. This tells us how much CO₂ is emitted during the production of a pair. To calculate this, we measured the emissions from the raw materials to the first use**.

The result is that the CO₂ footprint of the uvex 1 G2 planet is 7.1 kg. This is roughly equivalent to a 35 km car journey.

By using recycled and bio-based materials, we were able to reduce the CO₂ footprint by 1.2 kg or 13.6% compared to our regular uvex 1 G2 (art. no. 68342, CO₂ footprint 8.5 kg).

Calculations based on Sima Pro 9.2.0.1, ecoinvent 3.6 database



40%
recycled material
in the TPR scuffcap

100%
recycled
shoelaces

Penetration resistance
made from
100%
recycled fibres

uvex x-tended grip planet

10%

of TPU outsole is made of recycled
PU waste



Comfortable climatic insole

100%

recycled polyester and PU foam



uvex x-dry knit planet

100%

recycled PET bottles in
the upper



Distance mesh lining

18%

of the lining is made of bamboo,
52% made of recycled polyester



From the upper to the sole, the new uvex 1 G2 planet offers both sustainability and performance in one. In accordance with DIN EN ISO 14021:2016, it consists of 25% recycled materials in terms of weight, without compromising its protective properties and comfort compared to the well-known uvex 1 G2 models.

Many shoe components, such as the upper and insole, are made from 100% recycled materials. In addition, we already use some of our own PU waste for the production of the outsole: up to 10% is used in the uvex x-tended grip planet.

*calculated in accordance with DIN EN ISO 14021:2016
**the end-of-life emissions depend on the method of disposal.



Safety Footwear

uvex 1 G2 planet



68232



68242

clima zone



uvex 1 G2 planet · Shoe S1 P SRC

General features:

- extremely lightweight S1 P safety shoes made from recycled and sustainable materials
- made from synthetic materials, so suitable for people allergic to chrome
- all sole materials are free of silicone, plasticisers and other substances that interfere with wetting agents
- elastic laces for quick release and individual adjustment

Protection features:

- new, innovative uvex i-PUREnrj sole technology provides outstanding shock-absorption properties at the forefoot and heel, excellent rebound energy over the entire midsole and high levels of stability thanks to the foam heel basket
- uvex x-tended grip planet TPU outsole with up to 10% recycled PU waste from our production processes incorporates the latest biomechanical research, is highly durable and therefore offers excellent slip resistance. The tread is particularly suited to industrial floors
- meets the ESD specification with volume resistance under 35 mega-ohms
- the new wider, 100% metal-free uvex xenova® safety toe cap for more toe room and an optimum fit – compact design, anatomical shape, good lateral stability and no thermal conductivity
- penetration-resistant, non-metallic midsole made from 100% recycled material in accordance with the latest safety standards, does not restrict the flexibility of the shoe
- TPU scuffcap made from 40% recycled material protects the upper material

Comfort features:

- Breathable lining made from 18% bamboo and 52% recycled polyamid for optimised climate management
- uvex x-dry knit planet textile material made from 100% recycled PET bottles
- exceptional wearer comfort thanks to new wider last
- virtually seam-free construction made from textile material to eliminate pressure points
- removable antistatic comfortable insole with a surface made from 100% recycled PET bottles and foam consisting of recycled PU production waste and recycled PU; with moisture transport system, additional shock absorption around the heel and forefoot as well as excellent support for the arch of the foot
- soft padding on dust tongue and collar
- sizes 35 to 40 have been produced using a women's last

Sustainability:

- largely made from recycled materials in order to conserve resources
- free from harmful substances according to our restricted substances list

Areas of application:

- light applications

uvex 1 G2 planet	Shoe	Shoe
Art. no. Width 11	68232	68242
Standard EN ISO 20345:2011	S1 P SRC	S1 P SRC
Standard EN ISO 20345:2022	S1 PL FO SC SR	S1 PL FO SC SR
Upper	textile	textile
Lining	distance mesh lining	distance mesh lining
Sizes	35 to 52	35 to 52
Order unit	PR	PR

Safety Footwear

uvex 1 G2



68427
68428
68429
68420

68437
68438
68439
68430

68447
68448
68449
68440

68457
68458
68459
68450

clima zone



uvex 1 G2 · Sandal S1 SRC · Perforated shoe S1 SRC · Shoe S2 SRC · Lace-up boot S2 SRC

General features:

- ultra-lightweight S1 safety sandal, perforated safety shoe, S2 safety shoe/boot
- made from synthetic materials, so suitable for people allergic to chrome
- all sole materials are free of silicone, plasticisers and other paint wetting impairment substances
- individually adjustable elastic laces for quick release (shoes), individually adjustable double hook-and-loop fastening for the wearer's needs (sandal)

Protection features:

- new, innovative uvex i-PUREnrj sole technology with the highest level of shock-absorbing properties at the forefoot and at the heel, excellent rebound over the entire midsole and optimal stability thanks to the foam heel basket
- ergonomically designed TPU outsole uvex x-tended grip incorporates the latest biomechanical research, is highly durable and therefore offers excellent slip resistance. The tread is particularly suited to industrial floor surfaces
- meets the ESD specification with volume resistance under 35 megaohms
- new wider metal-free uvex xenova® protective toe cap for more toe room and optimum fit – compact design, anatomical shape, good lateral stability and no thermal conductivity

Comfort features:

- outstanding wearer comfort thanks to a newly developed last and climate-optimised, breathable materials
- virtually seam-free construction made from high-tech microvelour material to eliminate pressure points, perforated (S1 models) or hydrophobic (S2 models)
- removable antistatic comfortable insole with a moisture transport system, additional shock absorption around the heel and forefoot and excellent support for the arch
- soft padding on dust tongue (shoe, boot) and collar
- sizes 35 to 40 have been produced using a women's last

Sustainability:

- partly made from recycled materials in order to conserve resources
- free from harmful substances according to our restricted substances list

Areas of application:

- light applications



uvex 1 G2	Sandal	Perforated shoe	Shoe	Lace-up boot
Art. no. Width 10	68427	68437	68447	68457
Art. no. Width 11	68428	68438	68448	68458
Art. no. Width 12	68429	68439	68449	68459
Art. no. Width 14	68420	68430	68440	68450
Standard EN ISO 20345:2011	S1 SRC	S1 SRC	S2 SRC	S2 SRC
Standard EN ISO 20345:2022	S1 FO SR	S1 FO SR	S2 FO SR	S2 FO SR
Upper	microvelour	microvelour	microvelour	microvelour
Lining	distance mesh lining	distance mesh lining	distance mesh lining	distance mesh lining
Sizes	35 to 52	35 to 52	35 to 52	35 to 52
Order unit	PR	PR	PR	PR

Safety Footwear

uvex 1 G2



68341
68342
68343
68344



68361
68362
68363
68364



68371
68372
68373
68374

clima zone



uvex 1 G2 · Sandal S1 P SRC · Perforated shoe S1 P SRC · Shoe S1 P SRC

General features:

- ultra-lightweight S1 P safety sandal, perforated safety shoe
- made from synthetic materials, so suitable for people allergic to chrome
- all sole materials are free of silicone, plasticisers and other paint wetting impairment substances
- individually adjustable elastic laces for quick release (shoes), individually adjustable double hook-and-loop fastening for the wearer's needs (sandal)

Protection features:

- new, innovative uvex i-PUREnrj sole technology with the highest level of shock-absorbing properties at the forefoot and at the heel, excellent rebound over the entire midsole and optimal stability thanks to the foam heel basket
- ergonomically designed TPU outsole uvex x-tended grip incorporates the latest biomechanical research, is highly durable and therefore offers excellent slip resistance. The tread is particularly suited to industrial floor surfaces
- meets the ESD specification with volume resistance under 35 megaohms
- new wider metal-free uvex xenova® protective toe cap for more toe room and optimum fit – compact design, anatomical shape, good lateral stability and no thermal conductivity
- penetration-resistant, non-metallic midsole in accordance with current safety standards, does not restrict flexibility of the shoe

Comfort features:

- outstanding wearer comfort thanks to a newly developed last and climate-optimised, breathable materials
- virtually seam-free construction made from extremely breathable and hydrophobic uvex x-dry knit textile material (model 6834) or perforated high-tech microvelour material (models 6836 and 6837) to eliminate pressure point
- removable antistatic comfortable insole with a moisture transport system, additional shock absorption around the heel and forefoot and excellent support for the arch
- soft padding on collar and tongue
- sizes 35 to 40 have been produced using a women's last

Sustainability:

- partly made from recycled materials in order to conserve resources
- free from harmful substances according to our restricted substances list

Areas of application:

- light applications

uvex 1 G2	Shoe	Sandal	Perforated shoe
Art. no. Width 10	68341	68361	68371
Art. no. Width 11	68342	68362	68372
Art. no. Width 12	68343	68363	68373
Art. no. Width 14	68344	68364	68374
Standard EN ISO 20345:2011	S1 P SRC	S1 P SRC	S1 P SRC
Standard EN ISO 20345:2022	S1 PL FO SC SR	S1 PL FO SC SR	S1 PL FO SC SR
Upper	textile	microvelour	microvelour
Lining	distance mesh lining	distance mesh lining	distance mesh lining
Sizes	35 to 52	35 to 52	35 to 52
Order unit	PR	PR	PR

Safety Footwear

uvex 1 G2



68381
68382
68383
68384

68401
68402
68403



68391
68392
68393
68394

clima zone



uvex 1 G2 · Shoe S3 SRC · Lace-up boot S3 SRC

General features:

- ultra-lightweight S3 safety shoe, safety shoe/boot
- made from synthetic materials, so suitable for people allergic to chrome
- all sole materials are free of silicone, plasticisers and other paint wetting impairment substances
- individually adjustable elastic laces for quick release (shoe 68381 to 68384)
- BOA® Fit System (consisting of a micro-adjustable dial, super-strong lightweight laces and low friction lace guides) for a fast, effortless, precision fit (68401 to 68403)

Protection features:

- new, innovative uvex i-PUREnrj sole technology with the highest level of shock-absorbing properties at the forefoot and at the heel, excellent rebound over the entire midsole and optimal stability thanks to the foam heel basket
- ergonomically designed TPU outsole uvex x-tended grip incorporates the latest biomechanical research, is highly durable and therefore offers excellent slip resistance. The tread is particularly suited to industrial floor surfaces
- meets the ESD specification with volume resistance under 35 megaohms
- new wider metal-free uvex xenova® protective toe cap for more toe room and optimum fit – compact design, anatomical shape, good lateral stability and no thermal conductivity
- penetration-resistant, non-metallic midsole in accordance with current safety standards, does not restrict flexibility of the shoe

Comfort features:

- outstanding wearer comfort thanks to a newly developed last and climate-optimised, breathable materials
- virtually seam-free construction made from high-tech microvelour material to eliminate pressure points, hydrophobic
- removable antistatic comfortable insole with a moisture transport system, additional shock absorption around the heel and forefoot and excellent support for the arch
- soft padding on dust tongue and collar
- sizes 35 to 40 have been produced using a women's last

Sustainability:

- partly made from recycled materials in order to conserve resources
- free from harmful substances according to our restricted substances list

Areas of application:

- light applications



uvex 1 G2	Shoe	Shoe	Lace-up boot
Art. no. Width 10	68381	68401	68391
Art. no. Width 11	68382	68402	68392
Art. no. Width 12	68383	68403	68393
Art. no. Width 14	68384	-	68394
Standard EN ISO 20345:2011	S3 SRC	S3 SRC	S3 SRC
Standard EN ISO 20345:2022	S3L FO SC SR	S3L FO SC SR	S3L FO SC SR
Upper	microvelour	microvelour	microvelour
Lining	distance mesh lining	distance mesh lining	distance mesh lining
Sizes	35 to 52	35 to 52	35 to 52
Order unit	PR	PR	PR

You can find more information on uvex medicare on pages 405 to 413

Safety Footwear

uvex 1 G2



clima zone



uvex 1 G2 · sandal S1 SRC · Perforated shoe S1 SRC · Perforated lace-up boot S1 SRC · Perforated boot S1 SRC

General features:

- extremely lightweight S1 safety shoe
- made from synthetic materials, so suitable for people allergic to chrome
- all sole materials are free of silicone, plasticisers and other substances that interfere with wetting agents
- elastic laces for quick release and individual adjustment (shoes), individually adjustable double hook-and-loop fastening, for the wearer's needs (sandal and hook-and-loop fastening boot)

Protection features:

- new, innovative uvex i-PUREnrj sole technology provides outstanding shock-absorption properties at the forefoot and heel, excellent rebound energy over the entire midsole and high levels of stability thanks to the foam heel basket
- meets the ESD specification with volume resistance under 35 megaohms
- new wider, 100% metal-free uvex xenova® safety toe cap for more toe room and an optimum fit – compact design, anatomical shape, good lateral stability and no thermal conductivity

Comfort features:

- outstanding wearer comfort thanks to a new wider last and climate-optimised, breathable materials
- virtually seam-free construction made of perforated high-tech microvelour to eliminate pressure points
- removable antistatic comfortable insole with a moisture transport system, additional shock absorption around the heel and forefoot and excellent support for the arch of the foot
- soft padding on dust tongue (shoe, boot) and collar
- sizes 35 to 40 have been produced using a women's last

Sustainability:

- partly made from recycled materials in order to conserve resources
- free from harmful substances according to our restricted substances list

Areas of application:

- light applications

uvex 1 G2	Perforated shoe	sandal	Perforated shoe	Perforated lace-up boot	Perforated boot
Art. no. Width 10	68267	68287	68297	68317	-
Art. no. Width 11	68268	68288	68298	68318	-
Art. no. Width 12	-	68289	68299	68319	68329
Art. no. Width 14	-	68280	68290	68310	-
Standard EN ISO 20345:2011	S1 SRC	S1 SRC	S1 SRC	S1 SRC	S1 SRC
Standard EN ISO 20345:2022	S1 FO SR	S1 FO SR	S1 FO SR	S1 FO SR	S1 FO SR
Upper	microvelour	microvelour	microvelour	microvelour	microvelour
Lining	distance mesh lining	distance mesh lining	distance mesh lining	distance mesh lining	distance mesh lining
Sizes	35 bis 43	35 to 52	35 to 52	35 to 52	35 to 52
Order unit	PR	PR	PR	PR	PR

Safety Footwear

uvex 1 G2



68307
68308
68309
68300



68337
68338
68339
68330

clima zone



uvex 1 G2 · Shoe S2 SRC · Lace-up boot S2 SRC

General features:

- extremely lightweight S2 safety shoe
- made from synthetic materials, so suitable for people allergic to chrome
- all sole materials are free of silicone, plasticisers and other substances that interfere with wetting agents
- elastic laces for quick release and individual adjustment, standard laces included (shoe)

Protection features:

- new, innovative uvex i-PUREnrj sole technology provides outstanding shock-absorption properties at the forefoot and heel, excellent rebound energy over the entire midsole and high levels of stability thanks to the foam heel basket
- meets the ESD specification with volume resistance under 35 megaohms
- new wider, 100% metal-free uvex xenova® safety toe cap for more toe room and an optimum fit – compact design, anatomical shape, good lateral stability and no thermal conductivity

Comfort features:

- outstanding wearer comfort thanks to a new wider last and climate-optimised, breathable materials
- virtually seam-free construction made of high-tech microvelour to eliminate pressure points
- removable antistatic comfortable insole with a moisture transport system, additional shock absorption around the heel and forefoot and excellent support for the arch of the foot
- soft padding on dust tongue and collar
- sizes 35 to 40 have been produced using a women's last

Sustainability:

- partly made from recycled materials in order to conserve resources
- free from harmful substances according to our restricted substances list

Areas of application:

- light applications

uvex 1 G2	Shoe	Lace-up boot
Art. no. Width 10	68307	68337
Art. no. Width 11	68308	68338
Art. no. Width 12	68309	68339
Art. no. Width 14	68300	68330
Standard EN ISO 20345:2011	S2 SRC	S2 SRC
Standard EN ISO 20345:2022	S2 FO SR	S2 FO SR
Upper	microvelour	microvelour
Lining	distance mesh lining	distance mesh lining
Sizes	35 to 52	35 to 52
Order unit	PR	PR



Safety Footwear

uvex 1 G2



68487
68488
68489
68480

68467
68468
68469
68460

68477
68478
68479
68470



clima zone



uvex 1 G2 · Sandal S1 SRC · Perforated shoe S1 SRC · Perforated lace-up boot S1 SRC

General features:

- ultra-lightweight S1 safety sandal, perforated shoe and safety boot
- made from synthetic materials, so suitable for people allergic to chrome
- all sole materials are free of silicone, plasticisers and other paint wetting impairment substances
- individually adjustable elastic laces for quick release (shoe), individually adjustable double hook-and-loop fastening, for the wearer's needs (sandal)

Protection features:

- new, innovative uvex i-PUREnrj sole technology with the highest level of shock-absorbing properties at the forefoot and at the heel, excellent rebound over the entire midsole and optimal stability thanks to the foam heel basket
- meets the ESD specification with volume resistance under 35 megaohms
- new wider 100% metal-free uvex xenova® safety toe cap for more toe room and optimum fit – compact design, anatomical shape, good lateral stability and no thermal conductivity

Comfort features:

- outstanding wearer comfort thanks to a newly developed last and climate-optimised, breathable materials
- virtually seam-free upper in high-tech microvelour to eliminate pressure points, perforated
- removable antistatic comfortable insole with a moisture transport system, additional shock absorption around the heel and forefoot and excellent support for the arch
- soft padding on dust tongue (shoe, boot) and collar
- sizes 35 to 40 have been produced using a women's last

Sustainability:

- partly made from recycled materials in order to conserve resources
- free from harmful substances according to our restricted substances list

Areas of application:

- light applications

uvex 1 G2	Sandal	Perforated shoe	Perforated lace-up boot
Art. no. Width 10	68487	68467	68477
Art. no. Width 11	68488	68468	68478
Art. no. Width 12	68489	68469	68479
Art. no. Width 14	68480	68460	68470
Standard EN ISO 20345:2011	S1 SRC	S1 SRC	S1 SRC
Standard EN ISO 20345:2022	S1 FO SR	S1 FO SR	S1 FO SR
Upper	microvelour	microvelour	microvelour
Lining	distance mesh lining	distance mesh lining	distance mesh lining
Sizes	35 to 52	35 to 52	35 to 52
Order unit	PR	PR	PR

Safety Footwear

uvex 1 G2



68497
68498
68499
68490



68507
68508
68509
68500

clima zone



uvex 1 G2 · Shoe S2 SRC · Lace-up boot S2 SRC

General features:

- ultra-lightweight S2 safety shoe and safety boot
- made from synthetic materials, so suitable for people allergic to chrome
- all sole materials are free of silicone, plasticisers and other paint wetting impairment substances
- elastic laces for quick, individual adjustment (shoe)

Protection features:

- new, innovative uvex i-PUREnrj sole technology with the highest level of shock-absorbing properties at the forefoot and at the heel, excellent rebound over the entire midsole and optimal stability thanks to the foam heel basket
- meets the ESD specification with volume resistance under 35 megaohms
- new wider 100% metal-free uvex xenova® safety toe cap for more toe room and optimum fit – compact design, anatomical shape, good lateral stability and no thermal conductivity

Comfort features:

- outstanding wearer comfort thanks to a newly developed last and climate-optimised, breathable materials
- virtually seam-free upper in high-tech microvelour to eliminate pressure points, hydrophobic
- removable antistatic comfortable insole with a moisture transport system, additional shock absorption around the heel and forefoot and excellent support for the arch
- soft padding on dust tongue and collar
- sizes 35 to 40 have been produced using a women's last

Sustainability:

- partly made from recycled materials in order to conserve resources
- free from harmful substances according to our restricted substances list

Areas of application:

- light applications



uvex 1 G2	Shoe	Lace-up boot
Art. no. Width 10	68497	68507
Art. no. Width 11	68498	68508
Art. no. Width 12	68499	68509
Art. no. Width 14	68490	68500
Standard EN ISO 20345:2011	S2 SRC	S2 SRC
Standard EN ISO 20345:2022	S2 FO SR	S2 FO SR
Upper	microvelour	microvelour
Lining	distance mesh lining	distance mesh lining
Sizes	35 to 52	35 to 52
Order unit	PR	PR

uvex



Video



Winners at work – uvex 1 sport



Designed for Individuals



Sporty look.

Sporty design meets sophisticated functionality: The uvex 1 sport is both youthful and stylish combined with first-class wearer comfort, thanks to its lightweight design, climate optimised high-tech materials and ergonomically shaped outsole.

uvex 1 sport – the ideal companion for daily working life and more.

High breathability.

The breathable mesh upper ensures optimised climate control. The sporty look of the uvex 1 sport is contributing to the increased acceptance of wearing safety footwear.

Website



Lightweight and ergonomic design.

uvex 1 sport sole

- ergonomically designed outsole comprising dual-density polyurethane for light applications
- extremely comfortable underfoot
- suitable for general use on almost all surfaces
- excellent anti-slip properties (SRC)
- abrasion-resistant
- meets the ESD specification with volume resistance < 35 megaohms
- free of paint wetting impairment substances

Now also available as occupational shoes on page 284.

Safety Footwear

uvex 1 sport



65971
65972
65973
65974

65987
65988
65989
65980

65991
65992
65993
65994



clima zone



uvex 1 sport · Shoe S1 SRC/S1 P SRC

General features:

- modern, ultra lightweight and flexible S1 and S1 P safety shoe
- suitable for people allergic to chrome as it's made from synthetic materials
- all sole materials are free of silicones, plasticisers and other paint wetting impairment substances

Protection features:

- meets the ESD specification with volume resistance under 35 megaohms
- 100% metal-free uvex xenova® toe cap – compact design, anatomical shape, good lateral stability, no thermal conductivity
- ergonomically designed outsole made from dual density polyurethane with excellent slip resistance
- penetration-resistant, non-metallic midsole in accordance with the current safety standards, does not restrict flexibility of the shoe (S1 P shoes only)

Comfort features:

- outstanding wearer comfort thanks to a newly developed last and climate-optimised, breathable materials
- virtually seam-free construction made from high-tech materials to eliminate pressure points
- removable antistatic comfortable insole, with a moisture transport system and additional shock absorption around the heel and forefoot
- soft padding on collar and tongue
- sizes 35 to 40 have been produced using a women's last

Sustainability:

- partly made from recycled materials in order to conserve resources
- free from harmful substances according to our restricted substances list

Areas of application:

- light applications

uvex 1 sport	Shoe	Shoe	Shoe
Art. no. Width 10	65971	65987	65991
Art. no. Width 11	65972	65988	65992
Art. no. Width 12	65973	65989	65993
Art. no. Width 14	65974	65980	65994
Standard EN ISO 20345:2011	S1 P SRC	S1 SRC	S1 P SRC
Standard EN ISO 20345:2022	S1 PL FO SC SR	S1 FO SC SR	S1 PL FO SC SR
Upper	textile	textile	textile
Lining	distance mesh lining	distance mesh lining	distance mesh lining
Sizes	35 to 43	35 to 52	35 to 52
Order unit	PR	PR	PR

Safety Footwear

uvex 1 sport



S1P 65941
65942
65943
65944

S1 65947
65948
65949
65940

65961
65962
65963
65964

65901
65902
65903
65904

65921
65922
65923
65924



uvex 1 sport · Shoe S3 SRC/S1 P SRC/S1 SRC

General features:

- modern, ultra lightweight and flexible S1-, S1 P and S3 safety shoes
- suitable for people allergic to chrome as it's made from synthetic materials
- all sole materials are free of silicones, plasticisers and other paint wetting impairment substances

Protection features:

- meets the ESD specification with volume resistance less than 35 megaohms
- 100% metal-free uvex xenova® toe cap – compact design, anatomical shape, good lateral stability, no thermal conductivity
- ergonomically designed outsole comprising dual-density polyurethane with excellent slip resistance
- penetration-resistant, non-metallic midsole in accordance with the current safety standards, does not restrict flexibility of the shoe (S1P- and S3 Shoe)

Comfort features:

- outstanding wearer comfort thanks to a newly developed last and climate-optimised, breathable materials
- virtually seam-free construction made from high-tech materials to eliminate pressure points
- removable antistatic comfortable insole, with a moisture transport system and additional shock absorption around the heel and forefoot
- soft padding on collar and tongue
- sizes 35 to 40 have been produced using a women's last

Sustainability:

- partly made from recycled materials in order to conserve resources
- free from harmful substances according to our restricted substances list

Areas of application:

- light applications

uvex 1 sport	Shoe	Shoe	Shoe	Shoe	Shoe
Art. no. Width 10	65941	65947	65901	65961	65921
Art. no. Width 11	65942	65948	65902	65962	65922
Art. no. Width 12	65943	65949	65903	65963	65923
Art. no. Width 14	65944	65940	65904	65964	65924
Standard EN ISO 20345:2011	S1 P SRC	S1 SRC	S1 P SRC	S3 SRC	S3 SRC
Standard EN ISO 20345:2022	S1 PL FO SC SR	S1 FO SC SR	S1 PL FO SC SR	S3L FO SC SR	S3L FO SC SR
Upper	textile	textile	textile	microvelour	microvelour
Lining	distance mesh lining	distance mesh lining	distance mesh lining	distance mesh lining	distance mesh lining
Sizes	35 to 52	35 to 52	35 to 52	35 to 52	35 to 52
Order unit	PR	PR	PR	PR	PR

Occupational shoes

uvex 1 sport NC



65937
65938
65939



65957
65958
65959

clima zone



uvex 1 sport NC · Shoe O1 FO SRC

General features:

- modern, ultra-lightweight and flexible O1 occupational shoes without toe cap
- suitable for people allergic to chrome as it's made from synthetic materials
- all sole materials are free of silicones, plasticisers and other paint wetting impairment substances

Protection features:

- meets the ESD specification with volume resistance less than 35 megaohms
- ergonomically designed outsole comprising dual-density polyurethane with excellent slip resistance

Comfort features:

- outstanding wearer comfort thanks to a newly developed last and climate-optimised, breathable materials
- virtually seam-free construction made from high-tech materials to eliminate pressure points
- removable antistatic comfortable insole, with a moisture transport system and additional shock absorption around the heel and forefoot
- soft padding on collar and tongue
- sizes 35 to 40 have been produced using a women's last

Sustainability:

- partly made from recycled materials in order to conserve resources
- free from harmful substances according to our restricted substances list

Areas of application:

- light applications

uvex 1 sport NC	Shoe	Shoe
Art. no. Width 10	65937	65957
Art. no. Width 11	65938	65958
Art. no. Width 12	65939	65959
Standard EN ISO 20347:2011	O1 FO SRC	O1 FO SRC
Standard EN ISO 20347:2022	O1 FO SC SR	O1 FO SC SR
Upper	textile	textile
Lining	distance mesh lining	distance mesh lining
Sizes	35 to 52	35 to 52
Order unit	PR	PR

Safety Footwear

uvex 1 sport white



65807
65808
65809



65817
65818
65819



65821
65822
65823

clima zone



uvex 1 sport white - Shoe S2 SRC/S3 SRC

General features:

- modern, metal-free, ultra-lightweight and flexible S2 or S3 safety shoe
- upper made from hydrophobic microfibre material that is easy to clean
- minimal number of seams to reduce contamination
- made from synthetic materials, so suitable for people allergic to chrome
- washable at up to 30°C
- all sole materials are free of silicones, plasticisers and other paint wetting impairment substances

Protection features:

- meets the ESD specification with volume resistance under 35 megaohms
- 100% metal-free uvex xenova® protective toe cap – compact design, anatomical shape, good lateral stability and no thermal conductivity
- ergonomically designed outsole comprising dual density polyurethane with outstanding shock absorption and excellent slip resistance
- penetration-resistant, non-metallic midsole in accordance with current safety standards, does not restrict flexibility of the shoe (S3 shoe)

Comfort features:

- outstanding wearer comfort thanks to a newly developed last and climate-optimised, breathable materials
- virtually seam-free construction to eliminate pressure points
- removable antistatic comfortable insole, with a moisture transport system and additional shock absorption around the heel and forefoot
- padded dust tongue (S3 shoe) and collar
- sizes 35 to 40 have been produced using a women's last

Sustainability:

- partly made from recycled materials in order to conserve resources
- free from harmful substances according to our restricted substances list

Areas of application:

- light applications



uvex 1 sport white	Shoe	Shoe	Shoe
Art. no. Width 10	65807	65817	65821
Art. no. Width 11	65808	65818	65822
Art. no. Width 12	65809	65819	65823
Standard EN ISO 20345:2011	S2 SRC	S2 SRC	S3 SRC
Standard EN ISO 20345:2022	S2 FO SR	S2 FO SR	S3L FO SR
Upper	microfibre	microfibre	microfibre
Lining	distance mesh lining	distance mesh lining	distance mesh lining
Sizes	35 to 52	35 to 52	35 to 52
Order unit	PR	PR	PR

uvex

uvex 1 sport white NC
nrj. style. everyday.

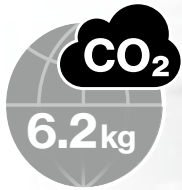

Date created 05/22



Sporty look.
Thanks to its lightweight design, high-tech materials and ergonomically designed outsole, uvex 1 sport white NC is the ideal companion for the working day and beyond.



Breathable and liquid-resistant.
The hydrophobic upper ensures optimised climate control and reliably protects the wearer against liquids and other contaminants.



Lightweight and ergonomic.
The dual-density polyurethane outsole offers excellent comfort underfoot thanks to its ergonomic design. The SRC-certified slip resistance means that it is suitable for use on almost all surfaces.



Wearer comfort.
Elastic laces for quick, individual adjustment.



uvex i-PUREnrj technology

- Shock-absorbing. Stabilising. Energy-returning.
- Outstanding shock absorption and energy return
- Excellent stability thanks to the internal heel cap, reducing the risk of injury.

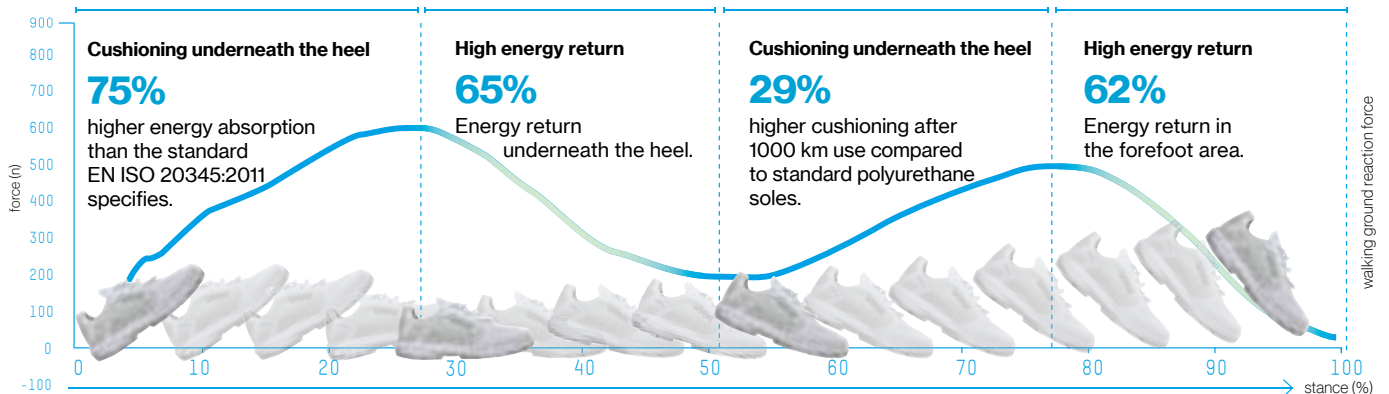

Occupational shoes

uvex 1 sport white NC



65707
65708
65709



65717
65718
65719



65727
65728
65729

clima zone



uvex 1 sport white NC · Shoe O1 FO SRC · Shoe O2 FO SRC

General features:

- modern, ultra-lightweight and flexible O1 or O2 occupational shoes without protective toe cap
- new, innovative uvex i-PUREnrj sole technology provides outstanding shock-absorption properties at the forefoot and heel and excellent rebound energy over the entire midsole
- hydrophobic upper materials (models 6571 and 6572) provide reliable protection against liquids and contaminants and are easy to clean
- washable at up to 30°C
- made from synthetic materials, so suitable for people allergic to chrome
- elastic laces for quick, individual adjustment (shoes 6570 and 6572)
- all sole materials are free of silicone, plasticisers and other paint wetting impairment substances

Protection features:

- meets the ESD specification with volume resistance under 35 megaohms
- ergonomically designed outsole comprising dual density polyurethane with excellent slip resistance

Comfort features:

- outstanding wearer comfort thanks to a newly developed last and climate-optimised, breathable materials
- virtually seam-free construction with high-tech materials to eliminate pressure points
- removable anti-static comfortable insole with a moisture transport system and additional shock absorption around the heel and forefoot
- soft padding on collar and tongue
- sizes 35 to 40 have been produced using a women's last

Sustainability:

- partly made from recycled materials in order to conserve resources
- free from harmful substances according to our restricted substances list

Areas of application:

- light applications



You can find more information at : www.uvex-safety.com/uvex1sportwhitenc

uvex 1 sport white NC	Shoe	Shoe	Shoe
Art. no. Width 10	65707	65717	65727
Art. no. Width 11	65708	65718	65728
Art. no. Width 12	65709	65719	65729
Standard EN ISO 20347:2011	O1 FO SRC	O2 FO SRC	O2 FO SRC
Standard EN ISO 20347:2022	O1 FO SC SR	O2 FO SR	O2 FO SR
Upper	textile	microfibre	microfibre
Lining	distance mesh lining	distance mesh lining	distance mesh lining
Sizes	35 to 52	35 to 52	35 to 52
Order unit	PR	PR	PR

uvex 1 – redefining performance

Next Level Equipment



Ideal shape around the joints for optimal torsion and good flexibility.

Self-cleaning tread optimised for slip resistance (SRC marking).

Outstanding flexibility. Optimum wearer comfort.

The ergonomic design of the outsole supports the natural movement and flexibility of the feet.



High abrasion-resistant TPU sections ensure secure stepping and rolling of the foot, which helps prevent accidents.

Jointed insert for securely climbing ladders.

Pivot point reduces pressure on joints when twisting and turning.



100% more shock absorption. Comfort in 3 dimensions.

The uvex 1 multilayer shock absorption system comprising a double-layered uvex 1 PU outsole and comfort insole with optimum shock absorption in the heel and the front of the foot helps protect the musculoskeletal system. The energy absorption in the heel is twice that required by EN ISO 20345. Pure walking comfort.



Outstanding stability. Reliable support and safety.

Consistent stability is essential for secure, sure-footedness and accident-free working. The visible external heel basket which is integrated into the sole ensures stability and offers additional side impact protection. The 'x-tended' support model offers additional sideways support and enhanced protection against ankle twisting and impact. Both sole versions securely enclose the foot, without limiting flexibility.



uvex monoskin shaft design. Pressure-free, comfortable fit.

The completely metal-free uvex monoskin upper shaft made from high-tech microfibre ensures outstanding wearer comfort without pressure points and the virtually seamless construction offers extended product life.



uvex climazone standard. Temperature and climate control.

Large perforations, ultra-breathable high-tech-micro velour upper and distance mesh lining material together with a comfortable insole with moisture control system prevents the build-up of heat and reduces sweat.

Safety Footwear

uvex 1



85427
85428
85429
85420

85437
85438
85439
85430

65657
65658
65659

BOA

 Focus Open 2013 Silver	 reddot design award winner 2013	 DESIGNPREIS DER BUNDESREPUBLIK DEUTSCHLAND 2014 NOMINIERT
--	---	---

clima zone



uvex 1 • Sandal S1 SRC • Perforated shoe S1 SRC

General features:

- ultra low weight, versatile S1 safety sandal and perforated safety shoe
- made from synthetic materials, so suitable for people allergic to chrome
- all sole materials are free of silicones, plasticisers and other paint wetting impairment substances
- two adjustable hook-and-loop straps (sandal) or elastic laces for quick, individual adjustment (shoe 8543)
- BOA® Fit System (consisting of a micro-adjustable dial, super-strong lightweight laces and low friction lace guides) for a fast, effortless, precision fit (shoe 6565)

Protection features:

- meets the ESD specification with volume resistance under 35 megaohms
- 100% metal-free uvex xenova® toe cap – compact design, anatomical shape, good lateral stability, no thermal conductivity
- ergonomically designed outsole made from dual density polyurethane with excellent slip resistance

Comfort features:

- outstanding wearer comfort results from a newly developed last and climate-optimised, breathable materials
- virtually seam-free construction made from high-tech microvelour material to eliminate pressure points
- removable antistatic comfortable insole, with a moisture transport system and additional shock absorption around the heel and forefoot
- soft padding on collar and tongue
- sizes 35 to 40 have been produced using a women's last

Sustainability:

- partly made from recycled materials in order to conserve resources
- free from harmful substances according to our restricted substances list

Areas of application:

- light applications



uvex 1	Sandal	Perforated shoe	Perforated shoe
Art. no. Width 10	85427	85437	65657
Art. no. Width 11	85428	85438	65658
Art. no. Width 12	85429	85439	65659
Art. no. Width 14	85420	85430	-
Standard EN ISO 20345:2011	S1 SRC	S1 SRC	S1 SRC
Standard EN ISO 20345:2022	S1 FO SR	S1 FO SR	S1 FO SR
Upper	microvelour	microvelour	microvelour
Lining	distance mesh lining	distance mesh lining	distance mesh lining
Sizes	35 to 52	35 to 52	35 to 52
Order unit	PR	PR	PR

You can find more information on uvex medicare on pages 405 to 413

Safety Footwear

uvex 1



85447
85448
85449
85440



65667
65668
65669



85457
85458
85459
85450

clima zone



uvex 1 • Shoe S2 SRC • Lace-up boot S2 SRC

General features:

- ultra low weight, versatile S2 safety shoe/boot
- made from synthetic materials, so suitable for people allergic to chrome
- all sole materials are free of silicones, plasticisers and other paint wetting impairment substances
- elastic laces for quick, individual adjustment (shoe 85444)
- BOA® Fit System (consisting of a micro-adjustable dial, super-strong lightweight laces and low friction lace guides) for a fast, effortless, precision fit (shoe 65666)

Protection features:

- meets the ESD specification with volume resistance under 35 megaohms
- 100% metal-free uvex xenova® toe cap – compact design, anatomical shape, good lateral stability, no thermal conductivity
- ergonomically designed outsole made from dual density polyurethane with excellent slip resistance

Comfort features:

- outstanding wearer comfort results from a newly developed last and climate-optimised, breathable materials
- virtually seam-free construction made from high-tech microvelour material to eliminate pressure points
- removable antistatic comfortable insole, with a moisture transport system and additional shock absorption around the heel and forefoot
- soft padding on collar and dust tongue
- sizes 35 to 40 have been produced using a women's last

Sustainability:

- partly made from recycled materials in order to conserve resources
- free from harmful substances according to our restricted substances list

Areas of application:

- light applications

uvex 1	Shoe	Shoe	Lace-up boot
Art. no. Width 10	85447	65667	85457
Art. no. Width 11	85448	65668	85458
Art. no. Width 12	85449	65669	85459
Art. no. Width 14	85440	-	85450
Standard EN ISO 20345:2011	S2 SRC	S2 SRC	S2 SRC
Standard EN ISO 20345:2022	S2 FO SR	S2 FO SR	S2 FO SR
Upper	microvelour	microvelour	microvelour
Lining	distance mesh lining	distance mesh lining	distance mesh lining
Sizes	35 to 52	35 to 52	35 to 52
Order unit	PR	PR	PR

Safety Footwear

uvex 1 ladies



85607
85608



85617
85618



85627
85628

clima zone



uvex 1 ladies · Sandal S1 SRC · Perforated shoe S1 SRC · Shoe S2 SRC

General features:

- ultra low weight, versatile safety shoes
- made from synthetic materials, so suitable for people allergic to chrome
- all sole materials are free of silicones, plasticisers and other paint wetting impairment substances
- two adjustable hook-and-loop straps (sandal)
- elastic laces for quick, individual adjustment

Protection features:

- meets the ESD specification with volume resistance under 35 megaohms
- 100% metal-free uvex xenova® toe cap – compact design, anatomical shape, good lateral stability, no thermal conductivity
- ergonomically designed outsole made from dual density polyurethane with excellent slip resistance

Comfort features:

- outstanding wearer comfort results from a newly developed last and climate-optimised, breathable materials with perforation (sandals)
- virtually seam-free construction made from high-tech microvelour material to eliminate pressure points
- removable antistatic comfortable insole, with a moisture transport system and additional shock absorption around the heel and forefoot
- soft padding on collar and tongue, S2 safety shoe with dust tongue

Sustainability:

- partly made from recycled materials in order to conserve resources
- free from harmful substances according to our restricted substances list

Areas of application:

- light applications

uvex 1	Sandal	Perforated shoe	Shoe
Art. no. Width 10	85607	85617	85627
Art. no. Width 11	85608	85618	85628
Standard EN ISO 20345:2011	S1 SRC	S1 SRC	S2 SRC
Standard EN ISO 20345:2022	S1 FO SR	S1 FO SR	S2 FO SR
Upper	microvelour	microvelour	microvelour
Lining	distance mesh lining	distance mesh lining	distance mesh lining
Sizes	35 to 52	35 to 52	35 to 52
Order unit	PR	PR	PR

Safety Footwear

uvex 1



85467
85468
85469



85477
85478
85479

clima zone



uvex 1 - Perforated shoe S1 SRC - Perforated lace-up boot S1 SRC

General features:

- ultra low weight and versatile perforated S1 safety shoe or boot
- made from synthetic materials, so suitable for people allergic to chrome
- all sole materials are free of silicones, plasticisers and other paint wetting impairment substances
- elastic laces for quick, individual adjustment (shoe)

Protection features:

- meets the ESD specification with volume resistance under 35 megaohms
- 100% metal-free uvex xenova® toe cap – compact design, anatomical shape, good lateral stability, no thermal conductivity
- ergonomically designed outsole made from dual density polyurethane with excellent slip resistance

Comfort features:

- outstanding wearer comfort results from a newly developed last and climate-optimised, breathable materials with perforation
- virtually seam-free construction made from high-tech microvelour material to eliminate pressure points
- removable antistatic comfortable insole, with a moisture transport system and additional shock absorption around the heel and forefoot
- soft padding on collar and tongue
- sizes 35 to 40 have been produced using a women's last

Sustainability:

- partly made from recycled materials in order to conserve resources
- free from harmful substances according to our restricted substances list

Areas of application:

- light applications

uvex 1	Perforated shoe	Perforated lace-up boot
Art. no. Width 10	85467	85477
Art. no. Width 11	85468	85478
Art. no. Width 12	85469	85479
Standard EN ISO 20345:2011	S1 SRC	S1 SRC
Standard EN ISO 20345:2022	S1 FO SR	S1 FO SR
Upper	microvelour	microvelour
Lining	distance mesh lining	distance mesh lining
Sizes	35 to 52	35 to 52
Order unit	PR	PR

Safety Footwear

uvex 1 x-tended support



85127
85128
85129



85117
85118
85119

 Focus Open 2013 Silver	 reddot design award winner 2013	 German Design Award WINNER 2015
--	---	--

clima zone



uvex 1 x-tended support · Perforated Shoe S1 SRC

General features:

- ultra low weight and versatile perforated S1 safety shoe
- made from synthetic materials, so suitable for people allergic to chrome
- all sole materials are free of silicones, plasticisers and other paint wetting impairment substances
- elastic laces for quick, individual adjustment

Protection features:

- meets the ESD specification with volume resistance under 35 megaohms
- 100% metal-free uvex xenova® toe cap – compact design, anatomical shape, good lateral stability, no thermal conductivity
- ergonomically designed outsole made from dual density polyurethane with excellent slip resistance
- 'x-tended' support: medial and lateral heel support for the foot with specially designed side frame – provides additional protection from ankle twisting, stabilises and guides the foot while providing impact protection

Comfort features:

- outstanding wearer comfort results from a newly developed last and climate-optimised, breathable materials with perforation
- virtually seam-free construction made from high-tech microvelour material to eliminate pressure points
- removable antistatic comfortable insole, with a moisture transport system and additional shock absorption around the heel and forefoot
- soft padding on collar and tongue
- sizes 35 to 40 have been produced using a women's last

Sustainability:

- partly made from recycled materials in order to conserve resources
- free from harmful substances according to our restricted substances list

Areas of application:

- light applications



uvex 1 x-tended support	Perforated shoe	Perforated shoe
Art. no. Width 10	85127	85117
Art. no. Width 11	85128	85118
Art. no. Width 12	85129	85119
Standard EN ISO 20345:2011	S1 SRC	S1 SRC
Standard EN ISO 20345:2022	S1 FO SR	S1 FO SR
Upper	microvelour	microvelour
Lining	distance mesh lining	distance mesh lining
Sizes	35 to 52	35 to 52
Order unit	PR	PR

Safety Footwear

uvex 1 x-tended support



85361
85362
85363

85141
85142
85143

65681
65682
65683



85191
85192
85193

clima zone



uvex 1 x-tended support · Sandal S1 P SRC · Perforated Shoe S1 P SRC

General features:

- ultra lightweight and versatile perforated S1 P safety shoe or sandal
- made from synthetic materials, so suitable for people allergic to chrome
- all sole materials are free of silicones, plasticisers and other paint wetting impairment substances
- foamed polyurethane scuffcap helps increase product life of upper
- elastic laces for quick, individual adjustment (shoes 8514 and 8519)
- two adjustable hook-and-loop straps (sandal)
- BOA® Fit System (consisting of a micro-adjustable dial, super-strong lightweight laces and low friction lace guides) for a fast, effortless, precision fit (shoe 6568)

Protection features:

- meets the ESD specification with volume resistance under 35 megaohms
- 100% metal-free uvex xenova® toe cap – compact design, anatomical shape, good lateral stability, no thermal conductivity
- ergonomically designed outsole made from dual density polyurethane with excellent slip resistance
- ‘x-tended’ support: medial and lateral heel support for the foot with specially designed side frame – provides additional protection from ankle twisting, stabilises and guides the foot while providing impact protection (only shoes)

- penetration-resistant, non-metallic midsole in accordance with the current safety standards, does not restrict flexibility of the shoe

Comfort features:

- outstanding wearer comfort results from a newly developed last and climate-optimised, breathable materials with perforation
- virtually seam-free construction made from high-tech microvelour material to eliminate pressure points
- removable antistatic comfortable insole, with a moisture transport system and additional shock absorption around the heel and forefoot
- soft padding on collar and tongue
- sizes 35 to 40 have been produced using a women’s last

Sustainability:

- free from harmful substances according to our restricted substances list

Areas of application:

- light applications

uvex 1 x-tended support	Sandal	Perforated shoe	Perforated shoe	Perforated shoe
Art. no. Width 10	85361	85141	65681	85191
Art. no. Width 11	85362	85142	65682	85192
Art. no. Width 12	85363	85143	65683	85193
Standard EN ISO 20345:2011	S1 P SRC	S1 P SRC	S1 P SRC	S1 P SRC
Standard EN ISO 20345:2022	S1 PL FO SR	S1 PL FO SR	S1 PL FO SR	S1 PL FO SR
Upper	microvelour	microvelour	microvelour	microvelour
Lining	distance mesh lining	distance mesh lining	distance mesh lining	distance mesh lining
Sizes	35 to 52	35 to 52	35 to 52	35 to 52
Order unit	PR	PR	PR	PR

You can find more information on uvex medicare on pages 405 to 413

Safety Footwear

uvex 1 x-tended support



85161
85162
85163



65671
65672
65673



85171
85172
85173

clima zone



uvex 1 x-tended support · Shoe S3 SRC · Lace-up boot S3 SRC

General features:

- ultra low weight, versatile S3 safety shoe/boot
- made from synthetic materials, so suitable for people allergic to chrome
- all sole materials are free of silicones, plasticisers and other paint wetting impairment substances
- foamed polyurethane scuffcap helps increase product life of upper
- elastic laces for quick, individual adjustment (shoe 8516)
- BOA® Fit System (consisting of a micro-adjustable dial, super-strong lightweight laces and low friction lace guides) for a fast, effortless, precision fit (shoe 6567)

Protection features:

- meets the ESD specification with volume resistance under 35 megaohms
- 100% metal-free uvex xenova® toe cap – compact design, anatomical shape, good lateral stability, no thermal conductivity
- ergonomically designed outsole made from dual density polyurethane with excellent slip resistance
- 'x-tended' support: medial and lateral heel support for the foot with specially designed side frame – provides additional protection from ankle twisting, stabilises and guides the foot while providing impact protection (shoe and boot)

- penetration-resistant, non-metallic midsole in accordance with the current safety standards, does not restrict flexibility of the shoe

Comfort features:

- outstanding wearer comfort thanks to a newly developed last and climate-optimised, breathable materials
- virtually seam-free construction made from high-tech microvelour material to eliminate pressure points
- removable antistatic comfortable insole, with a moisture transport system and additional shock absorption around the heel and forefoot
- soft padding on collar and dust tongue
- sizes 35 to 40 have been produced using a women's last

Sustainability:

- free from harmful substances according to our restricted substances list

Areas of application:

- light applications



uvex 1 x-tended support	Shoe	Shoe	Lace-up boot
Art. no. Width 10	85161	65671	85171
Art. no. Width 11	85162	65672	85172
Art. no. Width 12	85163	65673	85173
Standard EN ISO 20345:2011	S3 SRC	S3 SRC	S3 SRC
Standard EN ISO 20345:2022	S3L FO SR	S3L FO SR	S3L FO SR
Upper	microvelour	microvelour	microvelour
Lining	distance mesh lining	distance mesh lining	distance mesh lining
Sizes	35 to 52	35 to 52	35 to 52
Order unit	PR	PR	PR

uvex 1 business – the best of both worlds

Perfect for the office as well as the workshop.

Do you need to head straight from the meeting room to the production line? uvex's new line of safety shoes brings together three classic looks from the fashion world – Derby shoes, desert boots and Chelsea boots. uvex 1 business safety shoes can go wherever you go, managing to be stylish and safe at the same time! Their attractive appearance blends seamlessly with smart business and casual attire, while their steel cap provides maximum protection with plenty of toe room. Their first-class wearer comfort never fails to impress, from morning to night.

High wearer acceptance

This ultra-lightweight range of safety footwear in a modern business look is available in S2 and S3 versions, in stylish black, blue or grey.



Proven safety

The extra-wide steel cap, metal-free, penetration-resistant midsole and non-slip outsole, which exceeds the requirements of the standard for shock absorption by almost 100%, provide optimum protection.



Breathable materials

The highly breathable, chrome-free materials and antistatic comfortable insole ensure a pleasant foot climate, even during prolonged periods of use.



Comfortable fit

The innovative microvelour material with soft padding, or the soft, comfortable leather and insole with additional shock absorption around the heel and forefoot guarantee a pressure-free fit.



Orthopaedic solutions in accordance with German DGUV 112-191* and Austrian ONORM Z1259

clima zone



You can find more information at www.uvex-safety.com/uvex1business

* formerly BGR 191

Highstreet Fashion meets Safety



Safety Footwear

uvex 1 business



uvex 1 business · Shoe S2 SRC/S3 SRC · Lace-up boot S3 SRC · Slip-on boot S3 SRC

General features:

- modern, ultra-lightweight and flexible S2 and S3 safety shoes and boot: safe, stylish and super comfortable in a modern business look
- made from synthetic materials, so suitable for people allergic to chrome
- all sole materials are free of silicones, plasticisers and other paint wetting impairment substances

Protection features:

- meets the ESD specification with volume resistance under 35 megaohms
- robust, extra-wide steel toe cap for maximum wearer comfort
- ergonomically designed outsole made from polyurethane with excellent slip resistance
- penetration-resistant, non-metallic midsole in accordance with the current safety standards, does not restrict flexibility of the shoe (S3 models)

Comfort features:

- outstanding wearer comfort results from a newly developed last and climate-optimised, breathable materials
- made from high-tech microvelour for a soft, comfortable fit with no pressure points – with soft padding on the collar and a padded tongue
- removable antistatic comfortable insole, with a moisture transport system and additional shock absorption around the heel and forefoot

Sustainability:

- partly made from recycled materials in order to conserve resources
- free from harmful substances according to our restricted substances list

Areas of application:

- light applications

uvex 1 business	Shoe	Shoe	Lace-up boot	Slip-on boot
Art. no. Width 10	84697	84281	84271	84261
Art. no. Width 11	84698	84282	84272	84262
Art. no. Width 12	84699	84283	84273	84263
Standard EN ISO 20345:2011	S2 SRC	S3 SRC	S3 SRC	S3 SRC
Standard EN ISO 20345:2022	S2 FO SR	S3L FO SR	S3L FO SR	S3L FO SR
Upper	microvelour	microvelour	microvelour	microvelour
Lining	textile	textile	textile	textile
Sizes	39 to 52	39 to 52	39 to 52	39 to 52
Order unit	PR	PR	PR	PR

Safety Footwear

uvex 1 business



84301
84302
84303



84481
84482
84483



84491
84492
84493

clima zone



uvex 1 business · Shoe S3 SRC

General features:

- modern, extremely lightweight and flexible S3 safety shoes: safe, stylish and super comfortable in a modern business look
- made from synthetic materials, so suitable for people allergic to chrome (model 8430)
- all sole materials are free of silicone, plasticisers and other substances that interfere with wetting agents

Protection features:

- meets the ESD specification with volume resistance under 35 megaohms
- robust, extra-wide steel toe cap for maximum wearer comfort
- ergonomically designed polyurethane outsole with excellent slip resistance
- penetration-resistant, non-metallic midsole that meets the requirements of the current safety standards, does not restrict the flexibility of the shoe

Comfort features:

- outstanding wearer comfort thanks to a newly developed last and climate-optimised, breathable materials
- made from high-tech microvelour (model 8430) or soft, hydrophobic, full-grain leather (models 8448, 8449) for a soft, comfortable fit with no pressure points – with soft padding on the collar and a padded tongue
- removable anti-static comfortable insole with a moisture transport system and additional shock absorption around the heel and forefoot

Sustainability:

- partly made from recycled materials in order to conserve resources
- free from harmful substances according to our restricted substances list

Areas of application:

- light applications



uvex 1 business	Shoe	Shoe	Shoe
Art. no. Width 10	84301	84481	84491
Art. no. Width 11	84302	84482	84492
Art. no. Width 12	84303	84483	84493
Standard EN ISO 20345:2011	S3 SRC	S3 SRC	S3 SRC
Standard EN ISO 20345:2022	S3L FO SR	S3L FO SR	S3L FO SR
Upper	microvelour	water-repellent leather	water-repellent leather
Lining	textile	textile	textile
Sizes	39 to 52	39 to 52	39 to 52
Order unit	PR	PR	PR

Winners at Work – uvex 2

Pushing the Limits!



Superior performance across all disciplines

The innovative uvex 2 safety footwear range in protection classes S3 and S1 P is up for the challenge: delivering optimum shock absorption, ergonomic fit, low weight and excellent climate characteristics, ensuring maximum performance and redefining the limits for safety footwear.

Energy-Saving and Lightweight.
Helps prevent fatigue.

Shock Absorption System for Professionals.
Relieve strain with every step.

Reliable stability.
With maximum freedom of movement.

Pressure-free, comfortable fit.
Thanks to uvex monoskin shaft design.

Anatomically designed for optimum comfort and fit.

Comfortable underfoot with climate control.
Highly breathable thanks to uvex climazone.

100% better than the standard
With up to 40 joules of energy absorption in the heel area, the uvex 2 reduces strain on the body.

In spite of the penetration-resistant midsole the energy absorption in the heel is approximately twice that required by EN ISO 20345.

The uvex 2 multilayer shock absorption system and antistatic comfort insole with additional shock absorption elements at the heel and forefoot, help protect the musculoskeletal system on hard or rough terrain.

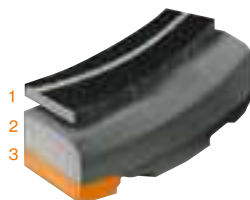

- 1 Comfort insole
- 2 PU midsole
- 3 PU or rubber outsole



Ultra lightweight
The uvex 2 range is one of the lightest S3 and S1 P safety footwear ranges for medium applications in its field.¹



Website



Video



Highly flexible

Enjoy unlimited freedom of movement, especially when kneeling, thanks to the flexible penetration resistant, metal-free midsole. The uvex no tie quick-lace system allows laces to be adjusted easily and adapt throughout the day keeping feet comfortable².

Excellent stability

The directly moulded PU scuffcap reliably protects the upper and prevents wear and tear when kneeling. The externally visible heel basket system integrated into the sole ensures sure-footedness and additional ankle protection without impairing comfort.

² Features depend on model.



uvex

uvex 2 – MACSOLE technology



The rubber technology MACSOLE®

MACSOLE® rubber technology has been used successfully for over 20 years to meet the special requirements for extremely innovative, comfortable safety shoes with very high quality standards. The patented rubber compound from the uvex safety group is used for both uvex and Heckel shoes to ensure optimum protection.

Rubber is known for its excellent properties in various fields of areas of applications: slip resistance, durability, abrasion resistance, grip, heat and cold resistance, chemical resistance and high elasticity characterize rubber.

Based on these properties uvex develops new rubber sole technologies under the MACSOLE® brand. The MACSOLE®-outsole is made from a special and exclusive one hundred percent rubber compound, the result of constant research by our R&D laboratories.



Durability

MACSOLE® outsoles are made of a unique and exclusive rubber compound offering exceptional abrasion resistance and prolong the service life of our products.



Grip

Due to its formulation, our exclusive MACSOLE® rubber offers an unparalleled level of slip resistance, which goes far beyond the requirements of the safety shoe standard.



Resistance to contact heat

Only rubber resists to contact heat up to 300°C and meets the additional requirement HRO of the safety shoe standard.

Shock absorption

The unique and exclusive rubber compound used for all MACSOLE® models, together with the soft PU midsole, ensures excellent shock absorption and natural elasticity. The natural elasticity of rubber ensures long-lasting shock absorption. MACSOLE® footwear helps to lower the risk of accidents by reducing fatigue caused by prolonged walking or standing.

Safety Footwear

uvex 2 STX MACSOLE®



65241
65242
65243



65251
65252
65253



sympatex®
clima zone



uvex 2 STX MACSOLE® · Shoe S3 WR HI HRO SRC · Lace-up boot S3 WR HI HRO SRC

General features:

- lightweight and flexible, waterproof safety shoe/boot in S3 WR
- made from synthetic materials, so suitable for people allergic to chrome
- foamed polyurethane scuffcap helps increase product life of upper
- elastic laces for quick, individual adjustment (shoe)

Protection features:

- waterproof and breathable thanks to sympatex® lining (WR marking)
- meets the ESD specification with volume resistance under 35 megaohms
- 100% metal-free uvex xenova® protective toe cap – compact design, anatomical shape, good lateral stability and no thermal conductivity
- ultra-lightweight, double-layer sole made from optimal shock-absorbing polyurethane midsole and uvex MACSOLE®-technology rubber outsole with excellent anti-slip properties
- HI marking for heat-insulating substructure (tested in accordance with standard at +150°C)
- HRO marking for heat-resistant substructure for brief exposure up to +300°C
- secure grip when climbing on ladders due to the stabilising arch support
- penetration-resistant, non-metallic midsole in accordance with current safety standards, does not restrict flexibility of the shoe

Comfort features:

- breathable yet waterproof thanks to sympatex® lining
- outstanding wearer comfort thanks to a newly developed last and climate-optimised, breathable materials
- virtually seam-free construction made from high-tech microvelour material to eliminate pressure points
- removable anti-static comfortable insole, with a moisture transport system and additional shock absorption around the heel and forefoot
- soft padding on dust tongue and collar
- increased low-temperature flexibility of uvex MACSOLE® rubber sole
- sizes 35 to 40 have been produced using a women's last

Sustainability:

- free from harmful substances according to our restricted substances list

Areas of application:

- medium applications



uvex 2 STX MACSOLE®	Shoe	Lace-up boot
Art. no. Width 10	65241	65251
Art. no. Width 11	65242	65252
Art. no. Width 12	65243	65253
Art. no. Width 14	-	-
Standard EN ISO 20345:2011	S3 WR HI HRO SRC	S3 WR HI HRO SRC
Standard EN ISO 20345:2022	S7L FO HI HRO SR	S7L FO HI HRO SR
Upper	microvelour	microvelour
Lining	sympatex® laminate	sympatex® laminate
Sizes	35 to 52	35 to 52
Order unit	PR	PR

Safety Footwear

uvex 2 MACSOLE®



uvex 2 MACSOLE® · Shoe S3 HI HRO SRC · Lace-up boot S3 HI HRO SRC

General features:

- lightweight and flexible S3 safety shoe/boot
- foamed polyurethane scuffcap helps increase product life of upper
- elastic laces for quick, individual adjustment (shoe 6522)
- BOA® Fit System (consisting of a micro-adjustable dial, super-strong lightweight laces and low friction lace guides) for a fast, effortless, precision fit (shoe 6531 and lace-up boot 6532)

Protection features:

- meets the ESD specification with a volume resistance of less than 35 megaohms
- 100% metal-free uvex xenova® toe cap – compact design, anatomical shape, good lateral stability, no thermal conductivity
- ultra lightweight, double-layer sole made from optimal shock-absorbing midsole and uvex MACSOLE®-technology rubber outsole with excellent anti-slip properties
- insulating shoe design (CI certification in accordance with EN ISO 20345, winter boot only)
- HI label for heat-insulating substructure (tested in accordance with standard at +150 °C)
- HRO label for heat-resistant substructure for brief exposure up to +300 °C
- secure grip when climbing on ladders due to the stabilising arch support

- penetration-resistant, non-metallic midsole in accordance with the current safety standards, does not restrict flexibility of the shoe or create thermal bridges

Comfort features:

- outstanding wearer comfort results from a newly developed last and climate-optimised, breathable materials
- virtually seam-free construction made from particularly soft cowhide leather to eliminate pressure points
- removable antistatic comfortable insole, with a moisture transport system and additional shock absorption around the heel and forefoot
- soft padding on collar and dust tongue
- increased low-temperature flexibility of the uvex MACSOLE® rubber sole
- sizes 35 to 40 have been produced using a women's last

Sustainability:

- free from harmful substances according to our restricted substances list

Areas of application:

- medium applications

uvex 2 MACSOLE®	Shoe	Shoe	Lace-up boot	Lace-up boot	Winter lace-up boot
Art. no. Width 10	65221	65311	65231	65321	-
Art. no. Width 11	65222	65312	65232	65322	-
Art. no. Width 12	65223	65313	65233	65323	65303
Art. no. Width 14	65224	-	65234	-	-
Standard EN ISO 20345:2011	S3 HI HRO SRC	S3 HI HRO SRC	S3 HI HRO SRC	S3 HI HRO SRC	S3 CI HI HRO SRC
Standard EN ISO 20345:2022	S3L FO HI HRO SR	S3L FO HI HRO SR	S3L FO HI HRO SR	S3L FO HI HRO SR	S3L FO CI HI HRO SR
Upper	water-repellent, full-grain smooth leather	water-repellent, full-grain smooth leather	water-repellent, full-grain smooth leather	water-repellent, full-grain smooth leather	water-repellent, full-grain smooth leather
Lining	distance mesh lining	distance mesh lining	distance mesh lining	textile	distance mesh lining
Sizes	35 to 52	35 to 52	35 to 52	35 to 52	35 to 52
Order unit	PR	PR	PR	PR	PR

You can find more information on uvex medicare on pages 405 to 413

Safety Footwear

uvex 2 MACSOLE®



65201
65202
65203
65204

65211
65212
65213
65214

65281
65282
65283
65284

65291
65292
65293
65294



clima zone



uvex 2 MACSOLE® · Sandal S1 P HRO SRC · Perforated shoe S1 P HRO SRC · Shoe S3 HI HRO SRC · Lace-up boot S3 HI HRO SRC

General features:

- lightweight and flexible safety shoes
- suitable for people allergic to chrome as made from synthetic materials
- foamed polyurethane scuffcap helps increase product life of upper
- two adjustable hook-and-loop straps (sandal) or elastic laces for quick, individual adjustment (shoes)

Protection features:

- meets the ESD specification with volume resistance less than 35 megaohms
- 100% metal-free uvex xenova® toe cap – compact design, anatomical shape, good lateral stability, no thermal conductivity
- ultra lightweight, double-layer sole made from optimal shock-absorbing polyurethane midsole and uvex MACSOLE®-technology rubber outsole with excellent anti-slip properties
- HI label for heat-insulating substructure (tested in accordance with standard at +150 °C, S3 models)
- HRO label for heat-resistant substructure for brief exposure up to +300 °C
- secure grip when climbing on ladders due to the stabilising arch support
- penetration-resistant, non-metallic midsole in accordance with the current safety standards, does not restrict flexibility of the shoe

Comfort features:

- outstanding wearer comfort results from a newly developed last and climate-optimised, breathable materials
- virtually seam-free construction made from high-tech microvelour material to eliminate pressure points
- removable antistatic comfortable insole, with a moisture transport system and additional shock absorption around the heel and forefoot
- soft padding on collar and dust tongue (S3 models)
- increased low-temperature flexibility of uvex MACSOLE® rubber sole
- sizes 35 to 40 have been produced using a women's last

Sustainability:

- free from harmful substances according to our restricted substances list

Areas of application:

- medium applications



uvex 2 MACSOLE®	Sandal	Perforated Shoe	Shoe	Lace-up boot
Art. no. Width 10	65201	65211	65281	65291
Art. no. Width 11	65202	65212	65282	65292
Art. no. Width 12	65203	65213	65283	65293
Art. no. Width 14	65204	65214	65284	65294
Standard EN ISO 20345:2011	S1 P HRO SRC	S1 P HRO SRC	S3 HI HRO SRC	S3 HI HRO SRC
Standard EN ISO 20345:2022	S1 PL FO HRO SR	S1 PL FO HRO SR	S3L FO HI HRO SR	S3L FO HI HRO SR
Upper	microvelour	microvelour	microvelour	microvelour
Lining	distance mesh lining	distance mesh lining	distance mesh lining	distance mesh lining
Sizes	35 to 52	35 to 52	35 to 52	35 to 52
Order unit	PR	PR	PR	PR

Safety Footwear

uvex 2



65021
65022
65023
65024

65031
65032
65033
65034



clima zone



uvex 2 · Shoe S3 SRC · Lace-up boot S3 SRC

General features:

- low weight and flexible S3 safety shoe/boot
- all sole materials are free of silicones, plasticisers and other paint wetting impairment substances
- foamed polyurethane scuffcap helps protect upper and increase product life
- elastic laces for quick, individual adjustment (shoe)

Protection features:

- meets the ESD specification with volume resistance under 35 megaohms
- 100% metal-free uvex xenova® toe cap – compact design, anatomical shape, good lateral stability, no thermal conductivity
- ergonomically designed outsole made from dual density polyurethane with a rough, self-cleaning tread and excellent slip resistance
- secure grip when climbing on ladders due to the stabilising arch support
- penetration-resistant, non-metallic midsole in accordance with the current safety standards, does not restrict flexibility of the shoe

Comfort features:

- outstanding wearer comfort results from a newly developed last and climate-optimised, breathable materials
- virtually seam-free construction made from particularly soft cowhide leather to eliminate pressure points
- removable antistatic comfortable insole, with a moisture transport system and additional shock absorption around the heel and forefoot
- soft padding on collar and dust tongue
- sizes 35 to 40 have been produced using a women's last

Sustainability:

- free from harmful substances according to our restricted substances list

Areas of application:

- medium applications

uvex 2	Shoe	Lace-up boot
Art. no. Width 10	65021	65031
Art. no. Width 11	65022	65032
Art. no. Width 12	65023	65033
Art. no. Width 14	65024	65034
Standard EN ISO 20345:2011	S3 SRC	S3 SRC
Standard EN ISO 20345:2022	S3L FO SR	S3L FO SR
Upper	water-repellent, full-grain smooth leather	water-repellent, full-grain smooth leather
Lining	distance mesh lining	distance mesh lining
Sizes	35 to 52	35 to 52
Order unit	PR	PR

Safety Footwear

uvex 2



65001
65002
65003
65004

65011
65012
65013
65014

65081
65082
65083
65084

65091
65092
65093
65094



clima zone



uvex 2 · Sandal S1 P SRC · Perforated shoe S1 P SRC · Shoe S3 SRC · Lace-up boot S3 SRC

General features:

- lightweight and flexible safety shoes
- suitable for people allergic to chrome as made from synthetic materials
- foamed polyurethane scuffcap helps increase product life of upper
- two adjustable hook-and-loop straps (sandal) or elastic laces for quick, individual adjustment (shoes)

Protection features:

- meets the ESD specification with a volume resistance of less than 35 megaohms
- 100% metal-free uvex xenova® toe cap – compact design, anatomical shape, good lateral stability, no thermal conductivity
- ergonomically designed outsole made from dual-density polyurethane with a rough, self-cleaning tread and excellent slip resistance
- secure grip when climbing on ladders due to the stabilising arch support
- penetration-resistant, non-metallic midsole in accordance with the latest safety standards, does not restrict the flexibility of the shoe

Comfort features:

- outstanding wearer comfort results from a newly developed last and climate-optimised, breathable materials
- virtually seam-free construction made from high-tech microvelour material to eliminate pressure points
- removable antistatic comfortable insole, with a moisture transport system and additional shock absorption around the heel and forefoot
- soft padding on collar and dust tongue (S3 models)
- sizes 35 to 40 have been produced using a women's last

Sustainability:

- free from harmful substances according to our restricted substances list

Areas of application:

- medium applications



uvex 2	Sandal	Perforated Shoe	Shoe	Lace-up boot
Art. no. Width 10	65001	65011	65081	65091
Art. no. Width 11	65002	65012	65082	65092
Art. no. Width 12	65003	65013	65083	65093
Art. no. Width 14	65004	65014	65084	65094
Standard EN ISO 20345:2011	S1 P SRC	S1 P SRC	S3 SRC	S3 SRC
Standard EN ISO 20345:2022	S1 PL FO SR	S1 PL FO SR	S3L FO SR	S3L FO SR
Upper	microvelour	microvelour	microvelour	microvelour
Lining	distance mesh lining	distance mesh lining	distance mesh lining	distance mesh lining
Sizes	35 to 52	35 to 52	35 to 52	35 to 52
Order unit	PR	PR	PR	PR

uvex

Safety Footwear
uvex 2 construction



The essential allrounder

Safe. Innovative. Robust.

The new uvex 2 construction was developed to meet the specific challenges of the construction industry. The construction and engineering industries really put workers and their footwear to the test. In addition to high mechanical stress, extreme weather conditions are often a factor too.

Thanks to their intelligent design and innovative technologies, the uvex 2 construction models offer reliable protection, stability and exceptional comfort.



clima zone



uvex waterstop technology
uvex waterstop technology reliably protects against water penetration for four times longer than required by the standard.



Stability and ankle protection
The anatomically shaped heel basket provides stability and protection against twisted ankles, especially on uneven surfaces.



Increased visibility
Reflective side strips provide optimal visibility and safety, especially in poorly lit working environments.



Safe slip resistance
The rough, self-cleaning tread ensures perfect grip without slipping, even on ladders or smooth surfaces.

Safety Footwear

uvex 2 construction



65101
65102
65103



65121
65122
65123



65131
65132
65133

uvex 2 construction · Lace-up boot S3 SRC

General features:

- robust, lightweight and modern S3 lace-up safety boot with wide fit
- all sole materials are free of silicone, plasticisers and other substances that interfere with wetting agents
- foamed polyurethane scuffcap helps increase the product life of the upper material covering the toe cap
- dirt-resistant, smooth-running and heat-resistant lacing system

Protection features:

- water-repellent leather with uvex waterstop technology for reliable protection against splashing water during rain and cleaning work
- trusted protection for the wearer and material: penetration-resistant steel midsole
- anatomical shape, moulded polyurethane heel basket for stability and protection against ankle twisting
- 100% metal-free uvex xenova® safety toe cap for more toe room and an optimum fit – compact design, anatomical shape, good lateral stability and no thermal conductivity
- ergonomically designed outsole made from dual-density polyurethane with a rough, self-cleaning tread and excellent slip resistance
- secure grip when climbing on ladders due to the stabilising arch support
- reflective side strips for optimum visibility

Comfort features:

- outstanding wearer comfort thanks to a newly developed last and climate-optimised, breathable materials
- virtually seam-free construction made from water-repellent leather to eliminate pressure points
- removable anti-static comfortable insole with a moisture transport system and additional shock absorption around the heel and forefoot
- soft padding on dust tongue and collar
- sizes 35 to 40 have been produced using a women's last

Sustainability:

- partly made from recycled materials in order to conserve resources
- free from harmful substances according to our restricted substances list

Areas of application:

- medium applications

► **uvex recommends footwear with steel midsoles for demanding applications such as construction and construction-related industries.**



uvex 2 construction	Lace-up boot	Lace-up boot	Lace-up boot
Art. no. Width 10	65101	65121	65131
Art. no. Width 11	65102	65122	65132
Art. no. Width 12	65103	65123	65133
Standard EN ISO 20345:2011	S3 SRC	S3 SRC	S3 SRC
Standard EN ISO 20345:2022	S3 FO SR	S3 FO SR	S3 FO SR
Upper	water repellent leather	water repellent leather	water repellent leather
Lining	textile	textile	textile
Sizes	35 to 52	35 to 52	35 to 52
Order unit	PR	PR	PR

uvex 2 xenova® – robust variety

Trend-setting all-rounder



Indoor and outdoor use

uvex 2 xenova® safety shoe series – exceptional, robust and comfortable shoes, whatever you're doing. Whether indoors or outdoors, the uvex 2 xenova® are the right choice for applications such as mechanical and plant engineering, metal processing, energy (generation, supply &

grid operation), municipal operations, motorway maintenance, railways, transport & logistics, airports, trades, ancillary construction work, horticulture and landscaping. uvex 2 xenova® – the trend-setting allrounders for a wide range of applications.

Metal-free safety

The uvex xenova® system offers high levels of safety thanks to its metal-free toe cap and optional metal-free, penetration-resistant

flexible midsole that keeps out the cold, and is lightweight and flexible for lasting wearer comfort.



Comfortable, lightweight shoes

The uvex 2 xenova® safety shoes do not compromise when it comes to comfort: shock-absorbing, extremely breathable, lightweight and a perfect fit thanks to

the unique combination of uvex technologies.



You can find more information at www.uvex-safety.com/uvex2xenova



uvex climazone standard The ultra-breathable high-tech microvelour upper material, distance mesh lining and comfortable insole with moisture transport system prevent the build-up of heat and reduce uncomfortable sweating.



Excellent fit due to newly developed last and uvex multiple fit system – available in 3 widths.

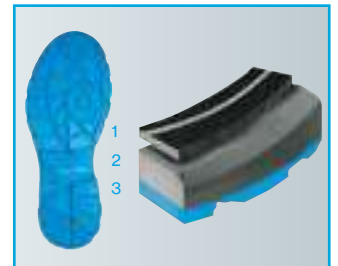

Lightweight and robust uvex dual density polyurethane sole with excellent slip resistance (SRC) and multi-layer shock absorption.



Safety Footwear

uvex 2 xenova®



S1 P | 95531 | **S1** | 95537
 95532 | 95538
 95533 | 95539



95547
 95548
 95549



95581
 95582
 95583



clima zone



uvex 2 xenova® · Sandal S1 SRC/S1 P SRC · Perforated shoe S1 SRC/S1 P SRC

General features:

- lightweight and modern S1 or S1 P safety sandals or shoes
- made from synthetic materials, so suitable for people allergic to chrome
- all sole materials are free of silicones, plasticisers and other paint wetting impairment substances
- double, individually adjustable hook and loop straps (sandal)
- BOA® Fit System (consisting of a micro-adjustable dial, super-strong lightweight laces and low-friction lace guides) for a fast, effortless, precision fit (shoe 9558)

Protection features:

- meets the ESD specification with volume resistance under 35 megaohms
- 100% metal-free uvex xenova® toe cap – compact design, anatomical shape, good lateral stability, no thermal conductivity
- penetration-resistant, non-metallic midsole in accordance with current safety standards, does not restrict flexibility of the shoe (sandal 95531-95533 and shoe 95581-95583)
- ergonomically designed outsole comprising dual density polyurethane with excellent slip resistance
- reflective elements for better visibility

Comfort features:

- lightweight with excellent shock-absorbing properties
- outstanding wearer comfort thanks to a newly developed last and climate-optimised, breathable materials, plus perforated upper
- removable antistatic comfortable insole, with a moisture transport system and additional shock absorption around the heel and forefoot
- soft padding on collar and tongue

Sustainability:

- partly made from recycled materials in order to conserve resources
- free from harmful substances according to our restricted substances list

Areas of application:

- medium applications

uvex 2 xenova®	Sandal	Sandal	Perforated shoe	Perforated shoe
Art. no. Width 10	95531	95537	95547	95581
Art. no. Width 11	95532	95538	95548	95582
Art. no. Width 12	95533	95539	95549	95583
Standard EN ISO 20345:2011	S1 P SRC	S1 SRC	S1 SRC	S1 P SRC
Standard EN ISO 20345:2022	S1 PL FO SR	S1 FO SR	S1 FO SR	S1 PL FO SR
Upper	microvelour	microvelour	microvelour	microvelour
Lining	distance mesh lining	distance mesh lining	distance mesh lining	distance mesh lining
Sizes	38 to 52	38 to 52	38 to 52	38 to 52
Order unit	PR	PR	PR	PR

Safety Footwear

uvex 2 xenova®



95577
95578
95579



95557
95558
95559



95567
95568
95569

clima zone



uvex 2 xenova® · Shoe S2 SRC · Lace-up boot S2 SRC

General features:

- extremely lightweight, versatile S2 safety shoe/boot
- made from synthetic materials, so suitable for people allergic to chrome (model 9557)
- all sole materials are free of silicones, plasticisers and other paint wetting impairment substances
- heat-resistant loop lacing system (leather models)

Protection features:

- meets the ESD specification with volume resistance under 35 megaohms
- 100% metal-free uvex xenova® safety toe cap – compact design, anatomical shape, good lateral stability and no thermal conductivity
- ergonomically designed outsole comprising dual density polyurethane with excellent slip resistance
- reflective elements for better visibility

Comfort features:

- lightweight with excellent shock-absorbing properties
- outstanding wearer comfort thanks to a newly developed last and climate-optimised, breathable materials, plus perforated upper
- removable anti-static comfortable insole with a moisture transport system and additional shock absorption around the heel and forefoot
- soft padding on collar and tongue

Sustainability:

- partly made from recycled materials in order to conserve resources
- free from harmful substances according to our restricted substances list

Areas of application:

- medium applications



uvex 2 xenova®	Shoe	Shoe	Lace-up boot
Art. no. Width 10	95577	95557	95567
Art. no. Width 11	95578	95558	95568
Art. no. Width 12	95579	95559	95569
Standard EN ISO 20345:2011	S2 SRC	S2 SRC	S2 SRC
Standard EN ISO 20345:2022	S2 FO SR	S2 FO SR	S2 FO SR
Upper	microvelour	water-repellent, full-grain leather	water-repellent, full-grain leather
Lining	distance mesh lining	distance mesh lining	distance mesh lining
Sizes	38 to 52	38 to 52	38 to 52
Order unit	PR	PR	PR

Safety Footwear

uvex 2 xenova®



95551
95552
95553



95561
95562
95563



95691
95692
95693



clima zone



uvex 2 xenova® · Shoe S3 SRC · Lace-up boot S3 SRC

General features:

- extremely lightweight, versatile S3 safety shoe/boot
- upper over the toe cap lasts longer thanks to the PU-coated scuffcap
- all sole materials are free of silicones, plasticisers and other paint wetting impairment substances
- heat-resistant loop lacing system
- BOA® Fit System (consisting of a micro-adjustable dial), super-strong lightweight laces and low-friction lace guides) for a fast, effortless, precision fit (boot 9569)

Protection features:

- meets the ESD specification with volume resistance under 35 megaohms
- 100% metal-free uvex xenova® safety toe cap – compact design, anatomical shape, good lateral stability and no thermal conductivity
- penetration-resistant, non-metallic midsole in accordance with the latest safety standards, does not restrict the flexibility of the shoe
- ergonomically designed outsole comprising dual density polyurethane with excellent slip resistance
- reflective elements for better visibility

Comfort features:

- lightweight with excellent shock-absorbing properties
- outstanding wearer comfort thanks to a newly developed last and climate-optimised, breathable materials, plus perforated upper
- removable antistatic comfortable insole, with a moisture transport system and additional shock absorption around the heel and forefoot
- soft padding on collar and tongue

Sustainability:

- partly made from recycled materials in order to conserve resources
- free from harmful substances according to our restricted substances list

Areas of application:

- medium applications

uvex 2 xenova®	Shoe	Lace-up boot	Boot
Art. no. Width 10	95551	95561	95691
Art. no. Width 11	95552	95562	95692
Art. no. Width 12	95553	95563	95693
Standard EN ISO 20345:2011	S3 SRC	S3 SRC	S3 SRC
Standard EN ISO 20345:2022	S3L FO SC SR	S3L FO SC SR	S3L FO SC SR
Upper	water-repellent, full-grain leather	water-repellent, full-grain leather	water-repellent, full-grain leather
Lining	distance mesh lining	distance mesh lining	distance mesh lining
Sizes	38 to 52	38 to 52	38 to 52
Order unit	PR	PR	PR

You can find more information on uvex medicare on pages 405 to 413

Safety Footwear

uvex motion 3XL



64963



uvex motion 3XL · Shoe S3 SRC

General features:

- extremely wide innovative shoe
- made from synthetic materials, so suitable for people allergic to chrome
- variable PU outsole individually adjustable to a range of protective modifications
- ample room for individually adapted insole for diabetic wearers

Protection features:

- meets the ESD specification with volume resistance under 35 megaohms
- 100% metal-free uvex xenova® toe cap means the entire shoe is neither thermally conductive nor magnetic
- penetration-resistant, non-metallic midsole in accordance with the current safety standards, does not restrict flexibility of the shoe
- extended uvex anti-twist heel cap significantly increases stability and offers improved protection from ankle twisting

Comfort features:

- virtually seam-free construction from high-tech microvelour material to eliminate pressure points
- soft padding on collar and padded dust tongue
- elastic laces for quick, individual adjustment
- individually changeable antistatic EVA insole

Sustainability:

- free from harmful substances according to our restricted substances list

uvex motion 3XL	Shoe
Art. no. Width >15	64963
Standard EN ISO 20345:2011	S3 SRC
Standard EN ISO 20345:2022	S3L FO SR
Upper	microvelour
Lining	distance mesh lining
Sizes	35 to 50
Order unit	PR

► Further information on this product can be found on pages 405 to 413



uvex

uvex 2 trend – safety and comfort redefined

Add a splash of colour to your day.

Whether in the assembly hall or on the production line, indoors or outdoors:

uvex 2 trend safety footwear range is suitable for medium applications (S1-S3) and incorporates numerous proven technologies at an affordable price. The uvex anti-twist heel cap for increased stability to prevent ankle twisting and the high-quality outsole materials combined with a sporty look and bold colours make this footwear appealing to wear. The result: maximum comfort and reliable safety.



Affordable Quality and Comfort

Sporty design

Contemporary colours and a long, flexible lacing area give the uvex 2 trend range a sporty look and a high degree of wearer acceptance.

Greater visibility

Reflective elements provide greater visibility – and therefore safety – even in poor light conditions.

Pleasant foot climate

The breathable, chrome-free microvelour material ensures a pleasant foot climate at all times, even during prolonged periods of use.



clima zone



Orthopaedic solutions in accordance with German DGUV 112-191* and Austrian ONORM Z1259



You can find more information at www.uvex-safety.com/uvex2trend



First-class wearer comfort

The midsole follows the lines of the arch, making the safety shoes especially comfortable to wear.



Safe slip resistance

The ergonomic design of the outsole supports the natural rolling motion of the foot. The new outsole profiles offer the best grip on almost any surface.



Sturdy scuffcap **

The directly moulded PU scuffcap on the S3 version reliably protects the upper against wear, especially during tasks that require kneeling.



Reliable protection against twisting

The innovative uvex anti-twist heel cap gives the foot extra support to avoid painful twisting.

* formerly BGR 191 ** on selected models



Safety Footwear

uvex 2 trend



S1 P | 69361
69362
69363 **S1** | 69367
69368
69369



69061
69062
69063



69461
69462
69463



uvex 2 trend - Sandal S1 SRC/S1 P SRC

General features:

- sporty S1 and S1 P safety sandal with a wide fit
- breathable microvelour is made from synthetic materials, so suitable for people allergic to chrome
- all sole materials are free of silicones, plasticisers and other paint wetting impairment substances
- double, individually adjustable counter-traction hook and loop straps

Protection features:

- meets the ESD specification with volume resistance under 35 megaohms
- reliable protection for the wearer and material: penetration-resistant steel midsole (S1 P models), steel toe cap and stabilising uvex anti-twist heel cap to prevent ankle twisting
- ergonomically designed outsole made from dual density polyurethane with excellent slip resistance
- reflective elements for better visibility

Comfort features:

- ideal foot climate constantly maintained due to uvex climazone: highly breathable lining and upper with perforation and comfortable climatic insole with moisture transport system
- soft, comfortable fit with no pressure points – with soft padding on the collar and a padded tongue
- removable antistatic comfortable insole, with a moisture transport system and additional shock absorption around the heel and forefoot

Sustainability:

- partly made from recycled materials in order to conserve resources
- free from harmful substances according to our restricted substances list

Areas of application:

- medium applications

uvex 2 trend	Sandal	Sandal	Sandal	Sandal
Art. no. Width 10	69361	69367	69061	69461
Art. no. Width 11	69362	69368	69062	69462
Art. no. Width 12	69363	69369	69063	69463
Standard EN ISO 20345:2011	S1 P SRC	S1 SRC	S1 P SRC	S1 P SRC
Standard EN ISO 20345:2022	S1 P FO SR	S1 FO SR	S1 P FO SR	S1 P FO SR
Upper	microvelour	microvelour	microvelour	microvelour
Lining	distance mesh lining	distance mesh lining	distance mesh lining	distance mesh lining
Sizes	36 to 52	36 to 52	38 to 52	38 to 52
Order unit	PR	PR	PR	PR

Safety Footwear

uvex 2 trend



69381
69382
69383

BOA

69081
69082
69083

BOA



S1 P | 69371 | **S1** | 69377
69372 | 69378
69373 | 69379

69077
69078
69079

69477
69478
69479



uvex 2 trend - Perforated shoe S1 SRC/S1 P SRC

General features:

- sporty S1 and S1 P safety shoe with a wide fit
- breathable microvelour is made from synthetic materials, so suitable for people allergic to chrome
- all sole materials are free of silicones, plasticisers and other paint wetting impairment substances
- BOA® Fit System (consisting of a micro-adjustable dial, super-strong lightweight laces and low friction lace guides) for a fast, effortless, precision fit (6938 and 6908)

Protection features:

- meets the ESD specification with volume resistance under 35 megaohms
- reliable protection for the wearer and material: penetration-resistant steel midsole (S1 P models), steel toe cap and stabilising uvex anti-twist heel cap to prevent ankle twisting
- ergonomically designed outsole made from dual density polyurethane with excellent slip resistance
- reflective elements for better visibility

Comfort features:

- ideal foot climate constantly maintained due to uvex climazone: highly breathable lining and upper with perforation and comfortable climatic insole with moisture transport system
- soft, comfortable fit with no pressure points – with soft padding on the collar and a padded tongue
- removable antistatic comfortable insole, with a moisture transport system and additional shock absorption around the heel and forefoot

Sustainability:

- partly made from recycled materials in order to conserve resources
- free from harmful substances according to our restricted substances list

Areas of application:

- medium applications



uvex 2 trend	Perforated shoe	Perforated shoe	Perforated shoe	Perforated shoe	Perforated shoe	Perforated shoe
Art. no. Width 10	69371	69377	69381	69077	69081	69477
Art. no. Width 11	69372	69378	69382	69078	69082	69478
Art. no. Width 12	69373	69379	69383	69079	69083	69479
Standard EN ISO 20345:2011	S1 P SRC	S1 SRC	S1 P SRC	S1 SRC	S1 P SRC	S1 SRC
Standard EN ISO 20345:2022	S1 P FO SR	S1 FO SR	S1 P FO SR	S1 FO SR	S1 P FO SR	S1 FO SR
Upper	microvelour	microvelour	microvelour	microvelour	microvelour	microvelour
Lining	distance mesh lining	distance mesh lining	distance mesh lining	distance mesh lining	distance mesh lining	distance mesh lining
Sizes	36 to 52	36 to 52	36 to 52	38 to 52	38 to 52	38 to 52
Order unit	PR	PR	PR	PR	PR	PR

Safety Footwear

uvex 2 trend



69397
69398
69399



69097
69098
69099



69497
69498
69499



uvex 2 trend · Shoe S2 SRC

General features:

- sporty S2 safety shoe with a wide fit
- breathable microvelour is made from synthetic materials, so suitable for people allergic to chrome
- all sole materials are free of silicones, plasticisers and other paint wetting impairment substances

Protection features:

- meets the ESD specification with volume resistance under 35 megaohms
- reliable protection for the wearer and material: steel toe cap and stabilising uvex anti-twist heel cap to prevent ankle twisting
- ergonomically designed outsole made from dual density polyurethane with excellent slip resistance
- reflective elements for better visibility

Comfort features:

- ideal foot climate constantly maintained due to uvex climazone: highly breathable lining and upper, and comfortable climatic insole with moisture transport system
- soft, comfortable fit with no pressure points – with soft padding on the collar and a padded tongue
- removable antistatic comfortable insole, with a moisture transport system and additional shock absorption around the heel and forefoot

Sustainability:

- partly made from recycled materials in order to conserve resources
- free from harmful substances according to our restricted substances list

Areas of application:

- medium applications

uvex 2 trend	Shoe	Shoe	Shoe
Art. no. Width 10	69397	69097	69497
Art. no. Width 11	69398	69098	69498
Art. no. Width 12	69399	69099	69499
Standard EN ISO 20345:2011	S2 SRC	S2 SRC	S2 SRC
Standard EN ISO 20345:2022	S2 FO SR	S2 FO SR	S2 FO SR
Upper	microvelour	microvelour	microvelour
Lining	distance mesh lining	distance mesh lining	distance mesh lining
Sizes	36 to 52	38 to 52	38 to 52
Order unit	PR	PR	PR

Safety Footwear

uvex 2 trend



69341
69342
69343

69347
69348
69349

69351
69352
69353

69357
69358
69359



uvex 2 trend · Shoe S2/S3 SRC · Lace-up boot S2/S3 SRC

General features:

- sporty S2 and S3 safety shoe/boot with a wide fit
- all sole materials are free of silicones, plasticisers and other paint wetting impairment substances
- dirt-resistant, smooth-running and heat-resistant lacing system
- upper over the toe cap is protected by the foamed scuffcap (S3 models)

Protection features:

- meets the ESD specification with volume resistance under 35 megaohms
- reliable protection for the wearer and material: penetration-resistant steel midsole (S3 models), steel toe cap and stabilising uvex anti-twist heel cap to prevent ankle twisting
- ergonomically designed outsole made from dual density polyurethane with excellent slip resistance
- reflective elements for better visibility

Comfort features:

- ideal foot climate constantly maintained due to uvex climazone: highly breathable lining and upper, and comfortable climatic insole with moisture transport system
- soft, comfortable fit with no pressure points – with soft padding on the collar and a padded tongue
- removable antistatic comfortable insole, with a moisture transport system and additional shock absorption around the heel and forefoot

Sustainability:

- partly made from recycled materials in order to conserve resources
- free from harmful substances according to our restricted substances list

Areas of application:

- medium applications



uvex 2 trend	Shoe	Shoe	Lace-up boot	Lace-up boot
Art. no. Width 10	69341	69347	69351	69357
Art. no. Width 11	69342	69348	69352	69358
Art. no. Width 12	69343	69349	69353	69359
Standard EN ISO 20345:2011	S3 SRC	S2 SRC	S3 SRC	S2 SRC
Standard EN ISO 20345:2022	S3 FO SR	S2 FO SR	S3 FO SR	S2 FO SR
Upper	Full-grain soft leather	Full-grain soft leather	Full-grain soft leather	Full-grain soft leather
Lining	distance mesh lining	distance mesh lining	distance mesh lining	distance mesh lining
Sizes	36 to 52	36 to 52	36 to 52	36 to 52
Order unit	PR	PR	PR	PR

uvex

uvex 3 – safety and comfort made easy.

The uvex 3 has been specially developed for the extreme demands faced in heavy applications. It combines necessary robustness with a sporty and dynamic design. Equipped with the latest uvex technologies, the uvex 3 reliably protects the wearer while providing high levels of comfort.

Hard work.
Easy going.



reddot winner 2022



Sustainability – recycled insole

The uvex 3 is sustainably produced and is free from harmful substances according to our restricted substances list. What's more, the insole is made of 100% recycled fibres and foam.



Extraordinary sensitivity

A high degree of sensitivity and the flexibility of the sole are especially important when operating machines controlled by foot.



uvex waterstop technology

uvex waterstop technology reliably protects against water penetration for four times longer than required by the standard.



uvex i-PUREnrj technology

uvex's innovative new polyurethane sole technology – uvex i-PUREnrj – returns the landing energy over the entire sole unit back to the wearer, redefining shock absorption and stability. The sole of the uvex 3 features a special anti-fatigue effect thanks to 68% energy return in the forefoot area, 65% energy return underneath the heel and the high shock absorption level of 44 joules.

bionom x
clima zone



Orthopaedic solutions in accordance with German DGUV 112-191* and Austrian ONORM Z1259



uvex anklepro

Provides excellent protection against impacts in the ankle area.

uvex lace lock

Optimised lacing for increased stability with locking lace hooks.



uvex bionom x

The uvex bionom x principle is an approach to creating new products that combines the essential biomechanical functions of the body with the functions of the footwear, thus creating a harmonious unit consisting of body, footwear and environment. Only when our body achieves its maximum performance level can it protect us from injury in the best possible way. uvex bionom x was developed in collaboration with our biomechanics expert Dr Caleb Wegener from the uvex safety group in Australia.



Safety Footwear

uvex 3



68741
68742
68743

**bionom x
clima zone**



uvex 3 - Lace-up boot S3 CI SRC

General features:

- robust, modern and lightweight lace-up safety boot with extra-wide fit
- all sole materials are free of silicone, plasticisers and other substances that interfere with wetting agents
- foamed polyurethane scuffcap helps increase the product life of the outer shoe material covering the toe cap
- smooth-running and dirt-resistant lacing system

Protection features:

- new, innovative uvex i-PUREnrj sole technology provides outstanding shock-absorption properties at the forefoot and heel, excellent rebound energy over the entire midsole and high levels of stability thanks to the foam heel basket
- innovative uvex bionom x design creates a biomechanical symbiosis between the foot, the upper, the sole and the floor
- water-repellent leather with uvex waterstop technology for reliable protection against splashing water during rain and cleaning work
- uvex anklepro extremely shock-absorbent ankle foam provides protection against painful impacts
- uvex lacelock fastening hook for a secure hold and more stability when lacing up the shoe
- meets the ESD specification with volume resistance under 35 megaohms
- penetration-resistant, non-metallic midsole in accordance with the current safety standards, does not restrict the flexibility of the shoe
- anatomical shaped, foamed polyurethane heel basket for stability and protection against ankle twisting
- 100% metal-free uvex xenova® safety toe cap for more toe room and an optimum fit – compact design, anatomical shape, good lateral stability and no thermal conductivity

- ergonomically designed outsole made from dual-density polyurethane with a rough, self-cleaning tread and excellent slip resistance
- secure grip when climbing on ladders due to the stabilising arch support
- reflective elements for optimum visibility

Comfort features:

- outstanding wearer comfort thanks to a newly developed last and climate-optimised, breathable materials
- virtually seam-free construction made from water-repellent leather to eliminate pressure points
- removable anti-static comfortable insole with a moisture transport system and additional shock absorption around the heel and forefoot
- soft padding on the leather dust tongue and collar made from abrasion-resistant textile

Sustainability:

- partly made from recycled materials in order to conserve resources
- free from harmful substances according to our restricted substances list

Areas of application:

- heavy applications

► **uvex recommends footwear with steel midsoles for demanding applications such as construction and construction-related industries.**

uvex 3	Lace-up boot
Art. no. Width 10	68741
Art. no. Width 11	68742
Art. no. Width 12	68743
Standard EN ISO 20345:2011	S3 CI SRC
Standard EN ISO 20345:2022	S3L FO CI SR
Upper	water repellent leather
Lining	textile
Sizes	36 to 52
Order unit	PR

Safety Footwear

uvex 3



68721
68722
68723



68731
68732
68733

**bionom x
clima zone**



uvex 3 - Lace-up boot S3 CI SRC

General features:

- robust, modern and lightweight lace-up safety boot with extra-wide fit
- all sole materials are free of silicone, plasticisers and other substances that interfere with wetting agents
- foamed polyurethane scuffcap helps increase the product life of the outer shoe material covering the toe cap
- smooth-running and dirt-resistant lacing system

Protection features:

- new, innovative uvex i-PUREnrj sole technology provides outstanding shock-absorption properties at the forefoot and heel, excellent rebound energy over the entire midsole and high levels of stability thanks to the foam heel basket
- innovative uvex bionom x design creates a biomechanical symbiosis between the foot, the upper, the sole and the floor
- water-repellent leather with uvex waterstop technology for reliable protection against splashing water during rain and cleaning work
- uvex anklepro extremely shock-absorbent ankle foam provides protection against painful impacts
- uvex lacelock fastening hook for a secure hold and more stability when lacing up the shoe
- meets the ESD specification with volume resistance under 35 megaohms
- reliable protection for the wearer and material: penetration-resistant steel midsole
- anatomical shaped, foamed polyurethane heel basket for stability and protection against ankle twisting
- 100% metal-free uvex xenova® safety toe cap for more toe room and an optimum fit – compact design, anatomical shape, good lateral stability and no thermal conductivity

- ergonomically designed outsole made from dual-density polyurethane with a rough, self-cleaning tread and excellent slip resistance
- secure grip when climbing on ladders due to the stabilising arch support
- reflective elements for optimum visibility

Comfort features:

- outstanding wearer comfort thanks to a newly developed last and climate-optimised, breathable materials
- virtually seam-free construction made from water-repellent leather to eliminate pressure points
- removable anti-static comfortable insole with a moisture transport system and additional shock absorption around the heel and forefoot
- soft padding on the leather dust tongue and collar insert made from perforated leather

Sustainability:

- partly made from recycled materials in order to conserve resources
- free from harmful substances according to our restricted substances list

Areas of application:

- heavy applications

► **uvex recommends footwear with steel midsoles for demanding applications such as construction and construction-related industries.**



uvex 3	Lace-up boot	Lace-up boot
Art. no. Width 10	68721	68731
Art. no. Width 11	68722	68732
Art. no. Width 12	68723	68733
Standard EN ISO 20345:2011	S3 CI SRC	S3 CI SRC
Standard EN ISO 20345:2022	S3 FO CI SR	S3 FO CI SR
Upper	water repellent leather	water repellent leather
Lining	textile	textile
Sizes	36 to 52	36 to 52
Order unit	PR	PR

uvex 3 asphaltpro

Reliable protection for extremely challenging applications



Heat resistance +300 °C (HRO)

Heat resistance tested at +300 °C (HRO)
Heat insulation tested at +150 °C (HI)
and at +250 °C (HI-3 according to standard
DIN EN ISO 20349-1 passed, not certifiable)



uvex waterstop technology
uvex waterstop technology reliably protects against water penetration for four times longer than required by the standard.



Stability and ankle protection
The anatomically shaped heel basket provides stability and protection against twisted ankles, especially on uneven surfaces.



Increased visibility
Reflective side strips provide optimal visibility and safety, especially in poorly lit working environments.



Flat tread on the outsole
Heat-resistant MACSOLE® rubber sole with flat tread to avoid tread marks. Excellent anti-slip properties on slippery and sloping roadsides.



Upper with uvex waterstop technology and reflective elements

Heat-insulating insock

Heat-insulating fleece on the insole

Penetration-resistant insert (steel)

Heat-insulating fleece

Midsole core for optimal shock absorption (PU wedge)

Heat-resistant MACSOLE® rubber outsole



Heat-insulating insock
Anti-static, comfortable insock with moisture transport system and additional shock absorption around the heel and forefoot with heat-insulating film in the forefoot

Safety Footwear

uvex 3 asphaltpro



65591
65592
65593

clima zone



uvex 3 asphaltpro · Lace-up boot S3 HI HRO SRA

General features:

- S3 heat-isolating safety boot designed for tarmac work
- heat-resistant MACSOLE® rubber sole with flat tread to avoid tread marks
- heat-insulating sole design and thermoregulating lining materials
- excellent heat insulation, even at extremely high temperatures

Protection features:

- heat-resistant sole design made of MACSOLE® rubber with polyurethane midsole core for optimum shock absorption, with heat-insulating insole
- water-repellent leather with uvex waterstop technology for reliable protection against splashing water during rain and cleaning work
- trusted protection for the wearer and material: penetration-resistant steel midsole
- anatomical shape, rubber heel basket for stability and protection against ankle twisting
- 100% metal-free uvex xenova® safety toe cap for more toe room and an optimum fit – compact design, anatomical shape, good lateral stability and no thermal conductivity
- ergonomically designed uvex MACSOLE® technology rubber outsole with excellent anti-slip properties
- reflective side strips for optimum visibility

Comfort features:

- outstanding wearer comfort thanks to a newly developed last and climate-optimised, breathable materials
- virtually seam-free design made from water-repellent leather to eliminate pressure points
- removable antistatic comfortable insole with a moisture transport system and additional shock absorption around the heel and forefoot
- soft padding on dust tongue and collar
- uvex MACSOLE® rubber sole for increased flexibility

Sustainability:

- free from harmful substances according to our restricted substances list

Areas of application:

- heavy applications



uvex 3 asphaltpro	Lace-up boot
Art. no. Width 10	65591
Art. no. Width 11	65592
Art. no. Width 12	65593
Standard EN ISO 20345:2011	S3 HI HRO SRA
Standard EN ISO 20345:2022	S3 FO HI HRO
Upper	water repellent leather
Lining	textile
Sizes	38 to 50
Order unit	PR

Safety Footwear

uvex quatro STX



84062

84072

sympatex®
clima zone



uvex quatro STX · Shoe S3 WR HI CI HRO SRC · Lace-up boot S3 WR HI CI HRO SRC

General features:

- robust and modern waterproof safety shoe/boot in S3 WR with extra-wide fit
- smooth-running, dirt-resistant lacing system
- highly resistant, water-repellent leather upper with foam scuffcap that also helps protect the material

Protection features:

- waterproof and breathable thanks to sympatex® lining (WR marking)
- dual-component sole, comprising shockabsorbing PU midsole and resistant, anti-slip rubber outsole
- outsole is highly resistant to chemicals and cut-resistant while also providing optimal protection against cold and heat
- reliable protection for wearers: penetrationresistant steel midsole, steel toe cap and the stabilising heel cap to prevent ankle twisting
- HI marking for heat-insulating substructure (tested in accordance with standard at +150°C)
- CI label for cold-insulating footwear design
- HRO marking for heat-resistant substructure for brief exposure up to +300°C

Comfort features:

- ideal foot climate constantly maintained due to uvex climazone: breathable sympatex® membrane lining and comfortable climatic insole with moisture transport system
- breathable yet waterproof thanks to sympatex® lining
- soft, padded collar (boot), soft, padded collar (shoe) and padded dust tongue
- removable antistatic insole for optimum foot support

Sustainability:

- partly made from recycled materials in order to conserve resources
- free from harmful substances according to our restricted substances list

Areas of application:

- heavy-duty applications

► **uvex recommends footwear with steel midsoles for demanding applications such as construction and construction-related industries.**

uvex quatro STX	Shoe	Lace-up boot
Art. no. Width 11	84062	84072
Standard EN ISO 20345:2011	S3 WR HI CI HRO SRC	S3 WR HI CI HRO SRC
Standard EN ISO 20345:2022	S7 FO HI CI HRO SR	S7 FO HI CI HRO SR
Upper	sturdy water repellent nappa leather	sturdy water repellent nappa leather
Lining	sympatex® laminate	sympatex® laminate
Sizes	38 to 48	38 to 48
Order unit	PR	PR

You can find more information on uvex medicare on pages 405 to 413

Safety Footwear

uvex quatro pro



clima zone



uvex quatro pro · Shoe S3 SRC · Lace-up boot S3 SRC · Winter lace-up boot S3 CI SRC · Winter zip boot S3 CI SRC/S2 CI SRC

General features:

- sturdy, modern safety shoes with extra wide fit
- smooth-running, dirt-resistant lacing system (lace-up models)

Protection features:

- highly resistant, water-repellent upper leather with foam scuffcap helps protect the upper
- outdoor sole design provides a high level of stability with a heel brace, support in the arch area and a rough, non-slip, self-cleaning tread
- reliable protection for wearers: penetration-resistant steel midsole, steel toe cap and stabilising uvex anti-twist heel cap to prevent ankle twisting
- cold-insulating shoe design (CI label in accordance with EN ISO 20345) (winterboots)

Comfort features:

- ideal foot climate constantly maintained due to uvex climazone: breathable textile lining and comfortable climatic insole with a moisture transport system
- soft, padded collar and padded dust tongue
- easy to put on and take off with the zip fastener on the inside (84032, 84039)
- antistatic uvex 3D hydroflex® foam insole for optimal shock absorption around heel and forefoot

Sustainability:

- partly made from recycled materials in order to conserve resources
- free from harmful substances according to our restricted substances list

Areas of application:

- heavy application

► **uvex recommends footwear with steel midsoles for demanding applications such as construction and construction-related industries.**

uvex quatro STX	Shoe	Lace-up boot	Winter boot	Winter boot	Winter boot
Art. no. Width 11	84002	84012	84022	84032	84039
Standard EN ISO 20345:2011	S3 SRC	S3 SRC	S3 CI SRC	S3 CI SRC	S2 CI SRC
Standard EN ISO 20345:2022	S3 FO SR	S3 FO SR	S3 FO CI SR	S3 FO CI SR	S2 FO CI SR
Upper	sturdy water repellent leather	sturdy water repellent leather	sturdy water repellent leather	sturdy water repellent leather	sturdy water repellent leather
Lining	textile	textile	textile	textile	textile
Sizes	38 to 50	38 to 50	38 to 50	38 to 50	38 to 50
Order unit	PR	PR	PR	PR	PR

Heckel safety shoes

Performance with style



A brand of the uvex group

Heckel, headquartered in France, has been a specialist in safety footwear since 1970 and is among the pioneers of the industry. Heckel has been part of the uvex group since 2001 and its products are distributed in over 30 countries.

Performance with style

Heckel stands for performance. When wearing Heckel safety shoes, users know they are fully protected and ready for the most extreme conditions. By not compromising on the quality and testing of our products, we guarantee the performance of our safety shoes and the protection of the professionals who wear them. Heckel safety shoes protect against mechanical and chemical risks as well as heat, cold and moisture, while emphasising style.

MACSOLE® technology

Being a true specialist in rubber soles, Heckel has been developing its own technology for more than 20 years: MACSOLE®. Made from an exclusive mixture of nitrile rubbers, MACSOLE® soles offer unrivalled performance in slip resistance, durability and comfort.

MACSOLE® ADVENTURE 3.0

OFF THE
BEATEN TRACK



Resistant and durable

MACSOLE® ADVENTURE 3.0 rubber soles guarantee unrivalled performance in slip resistance and durability and are also resistant to contact heat.

Designed for outdoor use

With a scuffcap made from highly abrasion-resistant rubber and the Agile Ankle Guard support system, these safety shoes are suitable for outdoor work and difficult surfaces.

Comfortable & wear-resistant

The natural elastic properties of rubber combined with innovative MACABSORB technology ensure shock absorption that is 85% higher than the standard for durable wearer comfort.



Safety Footwear



67323



67313

MACCROSSROAD 3.0 S3 LOW + HIGH S3 CI HI HRO SRC



MACSOLE® ADVENTURE 3.0 rubber **sole** with EVA MACABSORB inserts at the heel and forefoot | liquid-resistant oiled full-grain leather **upper** with Agile Ankle Guard reinforced heel and sides | polyester 3D mesh **lining** | non-metallic **toe cap** | non-metallic **penetration-resistant sole** | **hygienic insole** made from 85% recycled PU foam with shock absorption at the front and heel

Areas of application: heavy application

Partly made from recycled materials in order to conserve resources | Free from harmful substances according to our restricted substances list

	MACCROSSROAD 3.0 S3 LOW	MACCROSSROAD 3.0 S3 HIGH
Art. no. Width 10	67322	67312
Art. no. Width 11	67323	67313
Art. no. Width 12	67324	67314
Standard EN ISO 20345:2011	S3 CI HI HRO SRC	S3 CI HI HRO SRC
Standard EN ISO 20345:2022	S3L FO CI HI HRO SR	S3L FO CI HI HRO SR
Colours	black, lime	black, lime
Sizes	36 to 48	36 to 48
Weight	650 g	700 g
Order unit	PR	PR

Safety Footwear



67353



67363



MACCROSSROAD 3.0 S3 HIGH META S3 M CI HI HRO SRC + HIGH BOA S3 CI HI HRO SRC



MACSOLE® ADVENTURE 3.0 rubber **sole** with EVA MACABSORB inserts at the heel and forefoot | liquid-resistant oiled full-grain leather **upper** with Agile Ankle Guard reinforced heel and sides | BOA® Fit System easy, quick fastening solution with personalised adjustment (BOA) | D3O 100 J energy absorption highly flexible (META) **metatarsal protection** | polyester 3D mesh **lining** | non-metallic **toe cap** | non-metallic **penetration-resistant sole** | **hygienic insole** made from 85% recycled PU foam with shock absorption at the front and heel

Areas of application: heavy application

Partly made from recycled materials in order to conserve resources | Free from harmful substances according to our restricted substances list

	MACCROSSROAD 3.0 S3 HIGH META	MACCROSSROAD 3.0 S3 HIGH BOA
Art. no. Width 10	67352	67362
Art. no. Width 11	67353	67363
Art. no. Width 12	67354	67364
Standard EN ISO 20345:2011	S3 M CI HI HRO SRC	S3 CI HI HRO SRC
Standard EN ISO 20345:2022	S3L FO CI HI HRO M SR	S3L FO CI HI HRO SR
Colours	black, lime	black, blue
Sizes	36 - 48	36 - 48
Weight	740 g	700 g
Order unit	PR	PR



Safety Footwear



MACSTOPAC 300 S3 LOW + HIGH S3 HRO SRC



MACSOLE® PLUS 2.0 rubber **sole** | liquid-resistant oiled full-grain leather **upper** | distance mesh textile **lining** | non-metallic **toe cap** | non-metallic **penetration-resistant sole** | high moisture-absorbing **hygienic insole** made from 100% recycled PU foam

Areas of application: heavy application

Partly made from recycled materials in order to conserve resources | Free from harmful substances according to our restricted substances list

	MACSTOPAC 300 S3 LOW	MACSTOPAC 300 S3 HIGH
Art. no.	67533	67153
Standard EN ISO 20345:2011	S3 HRO SRC	S3 HRO SRC
Standard EN ISO 20345:2022	S3L FO HRO SR	S3L FO HRO SR
Colours	black	black
Sizes	37 - 48	37 - 48
Weight	640 g	690 g
Order unit	PR	PR

Safety Footwear



62993

ASPHALT



62963

EN 20349



MACSOLE® 1.0 NTX SBP CI HI HRO SRC + **WLD LOW** S3 CI HI-1 HRO WG SRC

MACSOLE® 1.0 smooth rubber **sole** (NTX) MACSOLE® 1.0 **rubber** (WLD LOW) | liquid-resistant pigmented full-grain leather **upper** | fire-resistant Kevlar® thread seams, pigmented full-grain leather protective flap, double Velcro® fastening (WLD LOW) | mesh **lining** | non-metallic **toe cap** | stainless steel **penetration-resistant sole** | aluminised **hygienic insole** with thermal insulation (NTX) and PU insole (WLD LOW)

Areas of application: model for surfacing work (NTX), welding, steelworking, protection against metal projection (WLD LOW)

Free from harmful substances according to our restricted substances list

	MACSOLE® 1.0 NTX	MACSOLE® 1.0 WLD LOW
Art. no.	62993	62963
Standard EN ISO 20345:2011	SB P WRU HI HRO SRA	-
Standard EN ISO 20345:2022	SB P FO WPA HI HRO	-
Standard EN ISO 20349-2:2017	-	S3 CI HI-1 HRO WG SRC
Colours	black	black
Sizes	38 - 48	38 - 48
Weight	780 g	810 g
Order unit	PR	PR



Safety Footwear

Accessories · Inlay soles



clima zone

Comfortable climatic insole uvex 1 G2 · uvex 1 G2 planet · uvex 3 · uvex 1 sport · uvex 1 sport white · uvex 1 sport NC · uvex 1 sport white NC · uvex 1 business · uvex 2 trend · uvex 1 · uvex 2 · uvex 2 construction · uvex 2 xenova®

- improved full-surface shock absorption
- ultra-breathable, moisture-absorbing and quick-drying materials
- shock absorption zones support natural movement of the foot
- non-irritating, comfortable surface structure
- antistatic properties
- arch support
- washable, hand wash at 30°C

Accessories - Inlay soles	Insole uvex 1 G2, uvex 1 G2 planet, uvex 3	Insole uvex 1 sport, uvex 1 sport white	Insole uvex 1 sport NC, uvex 1 sport white NC	Insole uvex 1 business	Insole uvex 2 trend	Insole uvex 1, uvex 2, uvex 2 construction, uvex 2 xenova®
Art. no. Width 10	94907	95797	95177	95157	95187	95347
Art. no. Width 11	94908	95798	95178	95158	95188	95348
Art. no. Width 12	94909	95799	95179	95159	95189	95349
Art. no. Width 14	94900	95790	-	-	-	95340
Version	for uvex 1 G2, uvex 1 G2 planet, uvex 3	for uvex 1 sport, uvex 1 sport white	for uvex 1 sport NC, uvex 1 sport white NC	for uvex 1 business	for uvex 2 trend	for uvex 1, uvex 2, uvex 2 construction, uvex 2 xenova®
Sizes	35 to 52	35 to 52	35 to 52	39 to 52	36 to 52	35 to 52
Order unit	PR	PR	PR	PR	PR	PR

Safety Footwear

Accessories · Inlay soles



LOW

Art. no. 95281
Art. no. 95284
Art. no. 95287
Sizes 35 to 52



MEDIUM

Art. no. 95282
Art. no. 95285
Art. no. 95288
Sizes 35 to 52



HIGH

Art. no. 95283
Art. no. 95286
Art. no. 95289
Sizes 35 to 52



clima zone

Comfortable tune-up

Antistatic insole concept for use in safety footwear. Designed to increase wearer comfort and enhance ergonomics by providing optimum support for the arches of the feet, helping to reduce foot fatigue.

- three different arch support versions: high, medium, low
- very good cushioning for comfort underfoot
- reduces symptoms of fatigue
- prevents pressure points
- non-irritating, comfortable surface structure
- breathable and absorbs moisture
- anti-bacterial
- antistatic
- suitable for ESD footwear
- hand-washable at 30°C
- certified for use in the following uvex safety shoes

Accessories - Inlay soles	uvex tune-up comfortable insole	uvex tune-up comfortable insole	uvex tune-up comfortable insole
Art. no. arch support low	95281	95284	95287
Art. no. arch support medium	95282	95285	95288
Art. no. arch support high	95283	95286	95289
Version certified in accordance with EN ISO 20345:2011 for the safety shoe types	uvex 1, uvex 2, uvex 2 xenova®	uvex 1 sport	uvex 1 G2
Sizes	35 to 52	35 to 52	35 to 52
Order unit	PR	PR	PR



clima zone

Comfortable climatic insole uvex 3D hydroflex® foam

- full shock absorption for the foot with additional shock-absorbing elements around the heel and under the forefoot to ensure comfort in exposed pressure zones
- ultra breathable and moisture-absorbent materials
- perforation for improved breathability
- shock absorption zones support natural foot movement
- non-irritating, comfortable surface structure
- antistatic properties
- arch support

Accessories - Inlay soles	Insole uvex quatro pro, uvex origin	Insole uvex motion style
Art. no. Width 11	95954	95956
Version	for uvex quatro pro, uvex origin	for uvex motion style
Sizes	38 to 50	36 to 50
Order unit	PR	PR

Safety Footwear

uvex care system



uvex nano shoe add on

footwear waterproofing for protection against moisture penetration and stains

The principle

Water-based uvex nano shoe “add on” waterproofing forms a colourless, invisible film on leather and textile surfaces which protects footwear from moisture penetration and water or oil stains. Although the technological expertise owes its origins to chemical nanotechnology, the product contains no actual nano particles. uvex nano shoe ‘add on’ makes footwear surfaces smooth so, that liquids simply run off. It does not alter the look or breathability of the impregnated material, irrespective of whether this is suede,

leather or textile. Contains no aggressive ingredients which might attack footwear surfaces.

How it works

- Protects from moisture penetration:
The speed at which moisture penetrates leather or textile surfaces which have been treated is significantly reduced. Water and oil simply run off.
- Maintains breathability:
uvex nano shoe ‘add on’ waterproofing does not affect the breathability of footwear surface materials.
- Improves cleaning
Footwear surfaces impregnated with uvex nano shoe ‘add on’ can be more easily cleaned, since water and oil stains cannot penetrate deep into the fabric.
- Long-lasting stain prevention:
Regular applications will significantly reduce repeated staining from water or oil-based liquids.

- No change to the look or feel of the surface:

The look or feel of footwear is not altered by the neutral uvex nano shoe ‘add on’ waterproofing. uvex nano shoe ‘add on’ is free from formaldehyde and phenol and contains no nano particles.

Application

- clean leather and textile surfaces thoroughly beforehand
- shake solution before use, then spray onto material to form a thin film over the surface (avoid drips forming)
- if necessary, wipe over excess liquid with a cloth to spread evenly
- leave to dry at room temperature for at least 12 hours
- repeat treatment as above when needed to maintain the effect

The nano shoe add on working principle

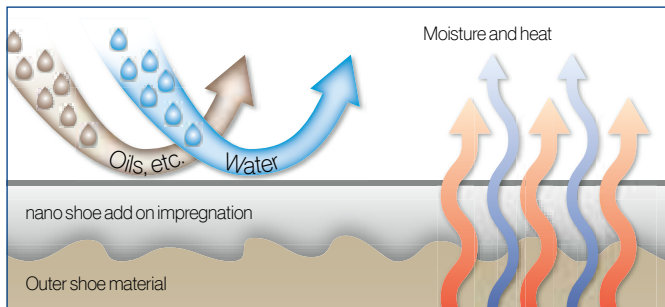

uvex nano shoe add on	
Art. no.	9698100
Content	100 ml
Order unit	PC



uvex nano shoe add in:

footwear disinfectant against foot odour and athlete's foot

The principle

uvex nano shoe ‘add in’ uses specially developed technology which releases controlled doses of active ingredients with long-lasting effect: The uvex nano shoe ‘add in’ disinfectant contains antimicrobial and antifungal active ingredients which eliminate bacteria and fungus over the longer term. Although this expertise owes its origins to chemical nanotechnology, the uvex nano shoe

‘add in’ does not contain any actual nano particles: The formula contains only active ingredients which are approved for use for a number of years and can be found in cosmetics (formaldehyde-free, phenol-free).

How it works

- Odour prevention:
Regular application of uvex nano shoe ‘add in’ in new shoes will prevent any build-up of odour from the outset. Unlike deodorants, which simply cover sweaty smells, this product deals with the underlying causes: bacteria.
- Ongoing deodorization:
Application of uvex nano shoe ‘add in’ will return footwear that has already been well worn to odour-neutral conditions.

- Kills fungi:
Filamentous or yeast fungi are among the most common causes of skin diseases (such as athlete's foot) affecting the feet. uvex nano shoe ‘add in’ kills existing fungi and prevents reoccurrence.

Application

- for use on the inside surfaces of all footwear
- spray uvex nano shoe ‘add in’ (about 5-10 doses) into your footwear outside in the open air. After 15 minutes drying time, your shoes will be ready to wear
- recommended initial treatment of badly affected footwear: three applications per week
- regular use will prevent odours and fungus developing in the longer term

The nano shoe add in working principle

Controlled release of germicidal agents to protect against foot odour and athletes foot

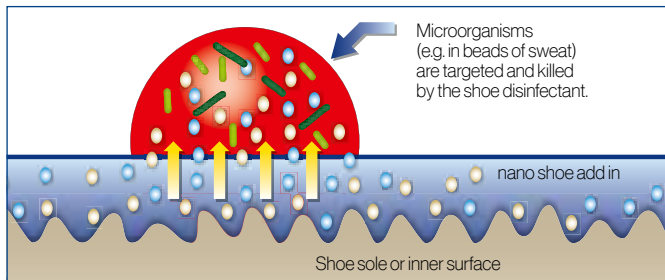

uvex nano shoe add in	
Art. no.	9698300
Content	125 ml
Order unit	PC

Safety Footwear

Polymer boot · Accessories



94756



94766



98754

NORA safety boots S5 SRC

General features:

- long PVC safety boot

Protection features:

- free of plasticisers included on the SVHC Candidate List of the REACH Regulation
- resistant to oil, grease, fuel, alkalis, acids and disinfectants
- with steel toecap and midsole
- toe and heel reinforcements plus ankle protection
- antistatic

Comfort features:

- anatomically shaped lasts, prevent foot fatigue
- leg height 33 cm (for size 42 boot)
- long shaft, can be shortened
- anatomically shaped insole
- pull-off aid

uvex tricot liner socks

- kind to the skin
- extremely high level of moisture absorption
- washable at up to 30 °C
- elastic



NORA safety boots S5 SRC

Art. no.	94756	94766
Standard EN ISO 20345:2011	S5 SRC	S5 SRC
Standard EN ISO 20345:2022	S5 FO	S5 FO
Upper	PVC	PVC
Sizes	37 to 48	36 to 47
Order unit	PR	PR

uvex tricot liner socks

Art. no.	98754
Sizes	39/40 to 47/48
Order unit	PR

Safety Footwear

Overview

Art. no.	Collection	Replacement insole	Page	Art. no.	Collection	Replacement insole	Page	Art. no.	Collection	Replacement insole	Page
64963	uvex motion 3XL	-	315	65673	uvex 1 x-tended support	95349	295	68337	uvex 1 G2	94907	277
65001	uvex 2	95347	307	65681	uvex 1 x-tended support	95347	294	68338	uvex 1 G2	94908	277
65002	uvex 2	95348	307	65682	uvex 1 x-tended support	95348	294	68339	uvex 1 G2	94909	277
65003	uvex 2	95349	307	65683	uvex 1 x-tended support	95349	294	68341	uvex 1 G2	94907	274
65004	uvex 2	95340	307	65707	uvex 1 sport white NC	95177	287	68342	uvex 1 G2	94908	274
65011	uvex 2	95347	307	65708	uvex 1 sport white NC	95178	287	68343	uvex 1 G2	94909	274
65012	uvex 2	95348	307	65709	uvex 1 sport white NC	95179	287	68344	uvex 1 G2	94900	274
65013	uvex 2	95349	307	65717	uvex 1 sport white NC	95177	287	68361	uvex 1 G2	94907	274
65014	uvex 2	95340	307	65718	uvex 1 sport white NC	95178	287	68362	uvex 1 G2	94908	274
65021	uvex 2	95347	306	65719	uvex 1 sport white NC	95179	287	68363	uvex 1 G2	94909	274
65022	uvex 2	95348	306	65727	uvex 1 sport white NC	95177	287	68364	uvex 1 G2	94900	274
65023	uvex 2	95349	306	65728	uvex 1 sport white NC	95178	287	68371	uvex 1 G2	94907	274
65024	uvex 2	95340	306	65729	uvex 1 sport white NC	95179	287	68372	uvex 1 G2	94908	274
65031	uvex 2	95347	306	65807	uvex 1 sport white	95797	285	68373	uvex 1 G2	94909	274
65032	uvex 2	95348	306	65808	uvex 1 sport white	95798	285	68374	uvex 1 G2	94900	274
65033	uvex 2	95349	306	65809	uvex 1 sport white	95799	285	68381	uvex 1 G2	94907	275
65034	uvex 2	95340	306	65817	uvex 1 sport white	95797	285	68382	uvex 1 G2	94908	275
65081	uvex 2	95347	307	65818	uvex 1 sport white	95798	285	68383	uvex 1 G2	94909	275
65082	uvex 2	95348	307	65819	uvex 1 sport white	95799	285	68384	uvex 1 G2	94900	275
65083	uvex 2	95349	307	65821	uvex 1 sport white	95797	285	68391	uvex 1 G2	94907	275
65084	uvex 2	95340	307	65822	uvex 1 sport white	95798	285	68392	uvex 1 G2	94908	275
65091	uvex 2	95347	307	65823	uvex 1 sport white	95799	285	68393	uvex 1 G2	94909	275
65092	uvex 2	95348	307	65901	uvex 1 sport	95797	283	68394	uvex 1 G2	94900	275
65093	uvex 2	95349	307	65902	uvex 1 sport	95798	283	68401	uvex 1 G2	94907	275
65094	uvex 2	95340	307	65903	uvex 1 sport	95799	283	68402	uvex 1 G2	94908	275
65101	uvex 2 construction	95347	309	65904	uvex 1 sport	95790	283	68403	uvex 1 G2	94909	275
65102	uvex 2 construction	95348	309	65921	uvex 1 sport	95797	283	68420	uvex 1 G2	94900	273
65103	uvex 2 construction	95349	309	65922	uvex 1 sport	95798	283	68427	uvex 1 G2	94907	273
65121	uvex 2 construction	95347	309	65923	uvex 1 sport	95799	283	68428	uvex 1 G2	94908	273
65122	uvex 2 construction	95348	309	65924	uvex 1 sport	95790	283	68429	uvex 1 G2	94909	273
65123	uvex 2 construction	95349	309	65937	uvex 1 sport NC	95177	284	68430	uvex 1 G2	94900	273
65131	uvex 2 construction	95347	309	65938	uvex 1 sport NC	95178	284	68437	uvex 1 G2	94907	273
65132	uvex 2 construction	95348	309	65939	uvex 1 sport NC	95179	284	68438	uvex 1 G2	94908	273
65133	uvex 2 construction	95349	309	65940	uvex 1 sport	95790	283	68439	uvex 1 G2	94909	273
65201	uvex 2 MACSOLE®	95347	305	65941	uvex 1 sport	95797	283	68440	uvex 1 G2	94900	273
65202	uvex 2 MACSOLE®	95348	305	65942	uvex 1 sport	95798	283	68447	uvex 1 G2	94907	273
65203	uvex 2 MACSOLE®	95349	305	65943	uvex 1 sport	95799	283	68448	uvex 1 G2	94908	273
65204	uvex 2 MACSOLE®	95340	305	65944	uvex 1 sport	95790	283	68449	uvex 1 G2	94909	273
65211	uvex 2 MACSOLE®	95347	305	65947	uvex 1 sport	95797	283	68450	uvex 1 G2	94900	273
65212	uvex 2 MACSOLE®	95348	305	65948	uvex 1 sport	95798	283	68457	uvex 1 G2	94907	273
65213	uvex 2 MACSOLE®	95349	305	65949	uvex 1 sport	95799	283	68458	uvex 1 G2	94908	273
65214	uvex 2 MACSOLE®	95340	305	65957	uvex 1 sport NC	95177	284	68459	uvex 1 G2	94909	273
65221	uvex 2 MACSOLE®	95347	304	65958	uvex 1 sport NC	95178	284	68460	uvex 1 G2	94900	278
65222	uvex 2 MACSOLE®	95348	304	65959	uvex 1 sport NC	95179	284	68467	uvex 1 G2	94907	278
65223	uvex 2 MACSOLE®	95349	304	65961	uvex 1 sport	95797	283	68468	uvex 1 G2	94908	278
65224	uvex 2 MACSOLE®	95340	304	65962	uvex 1 sport	95798	283	68469	uvex 1 G2	94909	278
65231	uvex 2 MACSOLE®	95347	304	65963	uvex 1 sport	95799	283	68470	uvex 1 G2	94900	278
65232	uvex 2 MACSOLE®	95348	304	65964	uvex 1 sport	95790	283	68477	uvex 1 G2	94907	278
65233	uvex 2 MACSOLE®	95349	304	65971	uvex 1 sport	95797	282	68478	uvex 1 G2	94908	278
65234	uvex 2 MACSOLE®	95340	304	65972	uvex 1 sport	95798	282	68479	uvex 1 G2	94909	278
65241	uvex 2 STX MACSOLE®	95347	303	65973	uvex 1 sport	95799	282	68480	uvex 1 G2	94900	278
65242	uvex 2 STX MACSOLE®	95348	303	65974	uvex 1 sport	95790	282	68487	uvex 1 G2	94907	278
65243	uvex 2 STX MACSOLE®	95349	303	65980	uvex 1 sport	95790	282	68488	uvex 1 G2	94908	278
65251	uvex 2 STX MACSOLE®	95347	303	65987	uvex 1 sport	95797	282	68489	uvex 1 G2	94909	278
65252	uvex 2 STX MACSOLE®	95348	303	65988	uvex 1 sport	95798	282	68490	uvex 1 G2	94900	279
65253	uvex 2 STX MACSOLE®	95349	303	65989	uvex 1 sport	95799	282	68497	uvex 1 G2	94907	279
65281	uvex 2 MACSOLE®	95347	305	65991	uvex 1 sport	95797	282	68498	uvex 1 G2	94908	279
65282	uvex 2 MACSOLE®	95348	305	65992	uvex 1 sport	95798	282	68499	uvex 1 G2	94909	279
65283	uvex 2 MACSOLE®	95349	305	65993	uvex 1 sport	95799	282	68500	uvex 1 G2	94900	279
65284	uvex 2 MACSOLE®	95340	305	65994	uvex 1 sport	95790	282	68507	uvex 1 G2	94907	279
65291	uvex 2 MACSOLE®	95347	305	68232	uvex 1 G2 planet	94908	272	68508	uvex 1 G2	94908	279
65292	uvex 2 MACSOLE®	95348	305	68242	uvex 1 G2 planet	94908	272	68509	uvex 1 G2	94909	279
65293	uvex 2 MACSOLE®	95349	305	68267	uvex 1 G2	94907	276	68721	uvex 3	94907	325
65294	uvex 2 MACSOLE®	95340	305	68268	uvex 1 G2	94908	276	68722	uvex 3	94908	325
65303	uvex 2 MACSOLE®	95349	304	68280	uvex 1 G2	94900	276	68723	uvex 3	94909	325
65311	uvex 2 MACSOLE®	95347	304	68287	uvex 1 G2	94907	276	68731	uvex 3	94907	325
65312	uvex 2 MACSOLE®	95348	304	68288	uvex 1 G2	94908	276	68732	uvex 3	94908	325
65313	uvex 2 MACSOLE®	95349	304	68289	uvex 1 G2	94909	276	68733	uvex 3	94909	325
65321	uvex 2 MACSOLE®	95347	304	68290	uvex 1 G2	94900	276	68741	uvex 3	94907	324
65322	uvex 2 MACSOLE®	95348	304	68297	uvex 1 G2	94907	276	68742	uvex 3	94908	324
65323	uvex 2 MACSOLE®	95349	304	68298	uvex 1 G2	94908	276	68743	uvex 3	94909	324
65591	uvex 3 asphaltPro	-	327	68299	uvex 1 G2	94909	276	69061	uvex 2 trend	95187	318
65592	uvex 3 asphaltPro	-	327	68300	uvex 1 G2	94900	277	69062	uvex 2 trend	95188	318
65593	uvex 3 asphaltPro	-	327	68307	uvex 1 G2	94907	277	69063	uvex 2 trend	95189	318
65657	uvex 1	95347	289	68308	uvex 1 G2	94908	277	69077	uvex 2 trend	95187	319
65658	uvex 1	95348	289	68309	uvex 1 G2	94909	277	69078	uvex 2 trend	95188	319
65659	uvex 1	95349	289	68310	uvex 1 G2	94900	277	69079	uvex 2 trend	95189	319
65667	uvex 1	95347	290	68317	uvex 1 G2	94907	277	69081	uvex 2 trend	95187	319
65668	uvex 1	95348	290	68318	uvex 1 G2	94908	277	69082	uvex 2 trend	95188	319
65669	uvex 1	95349	290	68319	uvex 1 G2	94909	277	69083	uvex 2 trend	95189	319
65671	uvex 1 x-tended support	95347	295	68329	uvex 1 G2	94909	276	69097	uvex 2 trend	95187	320
65672	uvex 1 x-tended support	95348	295	68330	uvex 1 G2	94900	277	69098	uvex 2 trend	95188	320

You can find more information on uvex medicare on pages 405 to 413

Art. no.	Collection	Replacement insole	Page
69099	uvex 2 trend	95189	320
69341	uvex 2 trend	95187	321
69342	uvex 2 trend	95188	321
69343	uvex 2 trend	95189	321
69347	uvex 2 trend	95187	321
69348	uvex 2 trend	95188	321
69349	uvex 2 trend	95189	321
69351	uvex 2 trend	95187	321
69352	uvex 2 trend	95188	321
69353	uvex 2 trend	95189	321
69357	uvex 2 trend	95187	321
69358	uvex 2 trend	95188	321
69359	uvex 2 trend	95189	321
69361	uvex 2 trend	95187	318
69362	uvex 2 trend	95188	318
69363	uvex 2 trend	95189	318
69367	uvex 2 trend	95187	318
69368	uvex 2 trend	95188	318
69369	uvex 2 trend	95189	318
69371	uvex 2 trend	95187	319
69372	uvex 2 trend	95188	319
69373	uvex 2 trend	95189	319
69377	uvex 2 trend	95187	319
69378	uvex 2 trend	95188	319
69379	uvex 2 trend	95189	319
69381	uvex 2 trend	95187	319
69382	uvex 2 trend	95188	319
69383	uvex 2 trend	95189	319
69397	uvex 2 trend	95187	320
69398	uvex 2 trend	95188	320
69399	uvex 2 trend	95189	320
69461	uvex 2 trend	95187	318
69462	uvex 2 trend	95188	318
69463	uvex 2 trend	95189	318
69477	uvex 2 trend	95187	319
69478	uvex 2 trend	95188	319
69479	uvex 2 trend	95189	319
69497	uvex 2 trend	95187	320
69498	uvex 2 trend	95188	320
69499	uvex 2 trend	95189	320
84002	uvex quatro pro	95954	329
84012	uvex quatro pro	95954	329
84022	uvex quatro pro	95954	329
84032	uvex quatro pro	95954	329
84039	uvex quatro pro	95954	329
84062	uvex quatro STX	-	328
84072	uvex quatro STX	-	328
84261	uvex 1 business	95157	298
84262	uvex 1 business	95158	298
84263	uvex 1 business	95159	298
84271	uvex 1 business	95157	298
84272	uvex 1 business	95158	298
84273	uvex 1 business	95159	298
84281	uvex 1 business	95157	298
84282	uvex 1 business	95158	298
84283	uvex 1 business	95159	298
84301	uvex 1 business	95157	299
84302	uvex 1 business	95158	299
84303	uvex 1 business	95159	299
84481	uvex 1 business	95157	299
84482	uvex 1 business	95158	299
84483	uvex 1 business	95159	299
84491	uvex 1 business	95157	299
84492	uvex 1 business	95158	299
84493	uvex 1 business	95159	299
84697	uvex 1 business	95157	298
84698	uvex 1 business	95158	298
84699	uvex 1 business	95159	298
85117	uvex 1 x-tended support	95347	293
85118	uvex 1 x-tended support	95348	293
85119	uvex 1 x-tended support	95349	293
85127	uvex 1 x-tended support	95347	293
85128	uvex 1 x-tended support	95348	293
85129	uvex 1 x-tended support	95349	293
85141	uvex 1 x-tended support	95347	294
85142	uvex 1 x-tended support	95348	294
85143	uvex 1 x-tended support	95349	294
85161	uvex 1 x-tended support	95347	294
85162	uvex 1 x-tended support	95348	294
85163	uvex 1 x-tended support	95349	294
85171	uvex 1 x-tended support	95347	295
85172	uvex 1 x-tended support	95348	295

Art. no.	Collection	Replacement insole	Page
85173	uvex 1 x-tended support	95349	295
85191	uvex 1 x-tended support	95347	294
85192	uvex 1 x-tended support	95348	294
85193	uvex 1 x-tended support	95349	294
85361	uvex 1 x-tended support	95347	294
85362	uvex 1 x-tended support	95348	294
85363	uvex 1 x-tended support	95349	294
85420	uvex 1	95340	289
85427	uvex 1	95347	289
85428	uvex 1	95348	289
85429	uvex 1	95349	289
85430	uvex 1	95340	289
85437	uvex 1	95347	289
85438	uvex 1	95348	289
85439	uvex 1	95349	289
85440	uvex 1	95340	290
85447	uvex 1	95347	290
85448	uvex 1	95348	290
85449	uvex 1	95349	290
85450	uvex 1	95340	290
85457	uvex 1	95347	290
85458	uvex 1	95348	290
85459	uvex 1	95349	290
85467	uvex 1	95347	292
85468	uvex 1	95348	292
85469	uvex 1	95349	292
85477	uvex 1	95347	292
85478	uvex 1	95348	292
85479	uvex 1	95349	292
85607	uvex 1 ladies	95347	291
85608	uvex 1 ladies	95348	291
85617	uvex 1 ladies	95347	291
85618	uvex 1 ladies	95348	291
85627	uvex 1 ladies	95347	291
85628	uvex 1 ladies	95348	291
94756	Accessories	-	339
94766	Accessories	-	339
94900	Inlay soles	-	336
94907	Inlay soles	-	336
94908	Inlay soles	-	336
94909	Inlay soles	-	336
95157	Inlay soles	-	336
95158	Inlay soles	-	336
95159	Inlay soles	-	336
95177	Inlay soles	-	336
95178	Inlay soles	-	336
95179	Inlay soles	-	336
95187	Inlay soles	-	336
95188	Inlay soles	-	336
95189	Inlay soles	-	336
95281	Inlay soles	-	337
95282	Inlay soles	-	337
95283	Inlay soles	-	337
95284	Inlay soles	-	337
95285	Inlay soles	-	337
95286	Inlay soles	-	337
95287	Inlay soles	-	337
95288	Inlay soles	-	337
95289	Inlay soles	-	337
95340	Inlay soles	-	336
95347	Inlay soles	-	336
95348	Inlay soles	-	336
95349	Inlay soles	-	336
95531	uvex 2 xenova®	95347	312
95532	uvex 2 xenova®	95348	312
95533	uvex 2 xenova®	95349	312
95537	uvex 2 xenova®	95347	312
95539	uvex 2 xenova®	95349	312
95547	uvex 2 xenova®	95347	312
95548	uvex 2 xenova®	95348	312
95549	uvex 2 xenova®	95349	312
95551	uvex 2 xenova®	95347	314
95552	uvex 2 xenova®	95348	314
95553	uvex 2 xenova®	95349	314
95557	uvex 2 xenova®	95347	313
95558	uvex 2 xenova®	95348	313
95559	uvex 2 xenova®	95349	313
95561	uvex 2 xenova®	95347	314
95562	uvex 2 xenova®	95348	314
95563	uvex 2 xenova®	95349	314
95567	uvex 2 xenova®	95347	313

Art. no.	Collection	Replacement insole	Page
95568	uvex 2 xenova®	95348	313
95569	uvex 2 xenova®	95349	313
95577	uvex 2 xenova®	95347	313
95578	uvex 2 xenova®	95348	313
95579	uvex 2 xenova®	95349	313
95581	uvex 2 xenova®	95347	312
95582	uvex 2 xenova®	95348	312
95583	uvex 2 xenova®	95349	312
95691	uvex 2 xenova®	95347	314
95692	uvex 2 xenova®	95348	314
95693	uvex 2 xenova®	95349	314
95790	Inlay soles	-	336
95797	Inlay soles	-	336
95798	Inlay soles	-	336
95799	Inlay soles	-	336
95954	Inlay soles	-	337
95956	Inlay soles	-	337
9698100	uvex nano shoe add on	-	338
9698300	uvex nano shoe add in	-	338
98754	Accessories	-	339



Art.no.	Collection	Page
67322	MACCROSSROAD 3.0 LOW	332
67323	MACCROSSROAD 3.0 LOW	332
67324	MACCROSSROAD 3.0 LOW	332
67312	MACCROSSROAD 3.0 HIGH	332
67313	MACCROSSROAD 3.0 HIGH	332
67314	MACCROSSROAD 3.0 HIGH	332
67352	MACCROSSROAD 3.0 HIGH META	333
67353	MACCROSSROAD 3.0 HIGH META	333
67354	MACCROSSROAD 3.0 HIGH META	333
67362	MACCROSSROAD 3.0 HIGH	333
67363	MACCROSSROAD 3.0 HIGH	333
67364	MACCROSSROAD 3.0 HIGH	333
67533	MACSTOPAC 300 LOW	334
67153	MACSTOPAC 300 HIGH	334
62993	MACSOLE 1.0 NTX	335
62963	MACSOLE 1.0 WLD LOW	335





This practical seminar will help you to analyse the dangers that employees face, determine what equipment is required to keep them safe and select the most appropriate protective footwear

- basic information on the areas of application of PPE footwear
- information on standards, the differences between primary and secondary requirements and their applications
- description of the labels found on protective footwear and the meaning of the various codes
- identification and assessment of dangers, developing a risk analysis strategy and understanding which safety equipment is necessary
- information on materials, production processes and areas of application including:
 - Upper materials and lining
 - Soles
 - Protective toecaps
 - Penetration-resistant inlay
- choosing the correct protective footwear for each application

Target group

Those responsible for the work-related health and safety of employees, e.g. health and safety officers, specialist purchasers and representatives of employee groups.



For more information or to book a place, please visit uvex-academy.de, call +49 (0)911 9736 1710 or email academy@uvex.de



Individual PPE

SBU Occupational Health

Individual personal protective equipment from uvex

MADE IN UVEX



INDIVIDUAL ADJUSTMENT

Individual personal protective equipment from uvex

The health of your employees is of central importance to us through the uvex vision **protecting people.**

uvex offers individual premium solutions for protecting the eyes, ears and feet – providing maximum safety for your team.

That's because standard solutions are not enough for uvex.

Individual personal protective equipment combines a high level of innovation and individual adjustment to the wearer, making each product unique. All products from the fields of optics, otoplastics and orthopaedics are customised, ensuring that they are tailor-made to the needs of your employees.

Protective equipment that fits your employees perfectly is more likely to be worn – giving your team reliable protection.

Our custom protective products are characterised in particular by their longevity. Compared to standard products (e.g., overspecs, disposable-hearing

protection), they are used for a much longer time, saving us valuable resources and, calculated over the entire period of use, producing much less waste.

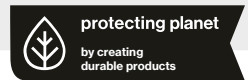

'Made in uvex'

Decades of experience and innovative technologies form the basis for products that are manufactured in accordance with the most stringent safety standards.

Whether it's eye, hearing or foot protection: Our individual personal protective equipment ensures that maximum levels of safety and comfort are provided.

Our innovations set new standards in quality and technology by combining excellent wearing comfort, attractive design and sophisticated functionality.

Our motto 'Made in uvex' guarantees a comprehensive quality system and the best possible processing technology. All materials used are free from harmful substances and are regularly inspected.

uvex places great importance on a sustainable production concept with first-class products and an in-house value creation chain, with a focus on production facilities in Germany and Europe. What's more, uvex offers maximum service with maximum flexibility.

CLAIM TO QUALITY

SBU Occupational Health

Individual personal protective equipment from uvex

Individual eye protection – uvex prescription safety spectacles

- certified prescription safety spectacles in accordance with EN 166 and Regulation (EU) 2016/425 on personal protective equipment
- wide selection of focus types and lens materials to meet all requirements
- the wide range of frames in different designs are available internationally and take into account the diverse head shapes of your employees
- qualified consultation and customisation by uvex specialists



Individual eye protection – uvex VDU spectacles

- VDU spectacles for professional use when working in front of a computer monitor and when no safety spectacles need to be worn
- wide selection of focus types and lens materials to meet all requirements
- qualified consultation and customisation by uvex specialists



Individual hearing protection – uvex high-fit

- certified otoplastic hearing protection in accordance with EN 352
- a wide selection of filters, otoplastic shapes and materials ensures that appropriate otoplastics are available for (virtually) all areas of application
- individual adjustments carried out by qualified specialists



Orthopaedic solutions for uvex safety shoes – uvex medicare

- certified orthopaedic safety footwear in accordance with EN ISO 20345:2011
- e.g. comfortable customised insoles and shoe adjustments
- wide range of usable uvex safety shoes
- uvex motion 3XL for extra-wide feet and medical conditions (e.g. diabetes)
- customisation by orthopaedics specialists



SBU Occupational Health

Individual personal protective equipment from uvex

**ONE BRAND.
ONE VISION.
ONE MISSION.**



OUR MISSION

#protecting people

The uvex brand mission. This is our objective and our responsibility. uvex protects people – when working, playing sport and pursuing leisure activities.

Decades of experience enable us to transfer expertise continuously between the sectors of industrial safety and top-level sport, and provides the foundation on which we are able to continuously develop our products.

It allows us to create innovations and solutions based on advanced technologies that reliably protect people – whether they are on a production line, on the ski slopes or on a mountain bike.

OUR FUTURE

Sustainable actions and social responsibility

If you rely on uvex, you are guaranteed sustainable actions. From environmental protection to social commitment: uvex puts corporate responsibility at the forefront of its daily business.

The focus of our commitment is to protect people:

- sustainable product concept
- avoidance of the use of hazardous beyond the requirements of the REACH regulation (the uvex banned hazardous substances list)
- uvex social standard for all manufacturing plants
- social commitment (e.g. Rainer Winter Foundation, Vision for the World)

OUR SERVICE

Time and location adapted to your needs

As an experienced specialist in occupational safety, uvex is able to offer an all-round professional service for individual personal protective equipment and meet the specific requirements of your company. Individual PPE products demand a wealth of expertise in the

consultation stage. This is why the adaptation is made by highly qualified experts – such as opticians, audiologists or orthopaedic shoe manufacturers – at a time and location to suit your needs.

RX web app:
Digital consultation tool for prescription safety eyewear.



Individual PPE:
For more information, visit our website.



uvexsafetygroup



uvexsafetygroup



uvexsafety



uvexsafetygroup



Prescription safety spectacles
and VDU spectacles

Prescription safety spectacles

Individual eye protection from uvex

**MADE FOR
YOUR EYES**
MADE IN **UVEX**



uvex prescription safety spectacles are individually adapted to the wearer's vision while offering the best possible protection in the workplace.

The spectacles are certified and marked in accordance with EN 166, so they can be used in workplaces where safety spectacles are mandatory. As occupational safety spectacles, they not only protect the eyes (from UV radiation, flying particles, dust etc.), but are also a visual aid because the lenses have a dioptric effect.

uvex offers a wide range of high-quality lens materials, focus types and frames. This makes it easier to switch between personal spectacles and employer-provided safety spectacles, which increases wearer acceptance.

The comprehensive uvex quality system guarantees the best design from an optical and processing technology perspective. All materials used (lenses, frames, cases etc.) are free from harmful substances and are regularly inspected.

The collection

uvex offers a variety of frames for prescription safety spectacles.

uvex RX bc plastic



- bc: basic collection
- in different shapes, sizes and colours

uvex RX bc metal



- bc: basic collection
- in different shapes, sizes and colours

uvex RX ti



- ti: titan
- made of high-quality titanium
- extremely stable
- lightweight
- allergy-neutral

uvex RX cb



- cb: custom bridge
- Suitable for people with:
- a flat nose bridge
 - high cheekbones
 - wide temples

uvex RX cd



- cd: comfort and design
- safety spectacles in a sporty design

uvex RX sp



- sp: sporty
- safety spectacles in a wrap-around design for anatomic sport lenses

uvex RX cd flip-up



- cd: comfort and design
- for workplaces with special requirements

uvex RX cf



- cf: close fit
- safety spectacles with all-round protection and tailored to your individual prescription
- recommended for handling chemicals and/or working in dusty environments

Prescription safety spectacles

Individual eye protection from uvex

uvex as a partner for individual protective equipment

Our eyesight needs special protection – and many activities in our working lives leave them vulnerable to serious risks. uvex does not compromise on eye protection and offers reliable protection with individually adapted safety spectacles.

Decades of experience and innovative technologies form the basis for uvex products, which are manufactured in accordance with the most stringent safety standards. In addition to safety, uvex also guarantees maximum comfort and quality. Protective equipment that fits properly not only offers reliable protection, but is more likely to be worn by the employee.

Our service – your benefits

uvex offers maximum service with maximum flexibility. Our specialists are happy to advise you with regard to professional and flexible solutions, tailored to the individual requirements of your company.

Our wide uvex collection enables us to find prescription safety spectacles for each of your employees.



uvex experts:

- on-site service from qualified opticians and master opticians
- qualified advisers in uvex customer service
- comprehensive uvex optical service partner network in Germany, Austria and Switzerland, as well as in other European countries



uvex flexibility:

- product consultation and adaptations on request.
- appointments are also possible during the early, late or night shift
- uvex online appointment tool optimises planning



uvex expertise:

- decades of experience in optics and continuous development of products
- training courses/practical seminars for your employees (e.g. company doctors, occupational safety specialists)
- 'Made in uvex' quality: First-class products with an in-house value creation chain and a focus on production facilities in Germany/Europe

The easy steps to your prescription safety spectacles

1 Scheduled appointment and consultation

Make an appointment by phone or email and get advice from uvex experts on prescription safety spectacles.

☎ +49 911 97361400

✉ customerservice.sbu-oh@uvex.de

2 Workplace analysis and product search

Our uvex specialists will be happy to present our uvex collection in person at your company and will conduct a workplace analysis with you to find the best products for you and your employees.

3 Finished prescription safety spectacles

After consulting and selecting your personal product, either on-site or at one of the uvex optical service partners, your prescription safety spectacles will be ready for you in a timely manner.

Please contact us for further, non-binding information.



Prescription safety spectacles

uvex international service expertise

UVEX SERVICE NETWORK

Service partners & opticians

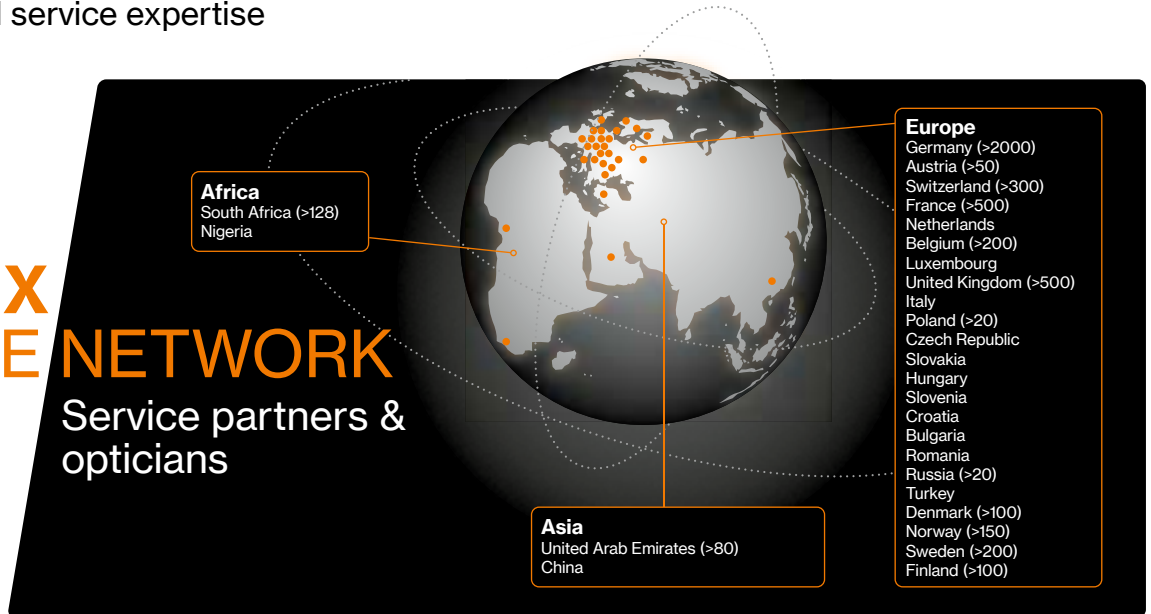

uvex strives to provide you and your employees with uvex prescription safety spectacles, no matter where your company is located. That's why we offer an international uvex network of production facilities and service partners in many countries. This network is continuously being expanded.



Perfect fit around the globe

Many frames can be anatomically adapted to different head shapes to ensure a perfect fit, e.g. for



high
cheek bones



flat
nose bridge



wide
temples

Our uvex RX cb and uvex RX cd collections meet the standard requirements for the field of view and coverage for both the European test head and the Asian test head.



Further information can be obtained via:

- +49 911 9736-1400
- customerservice.sbu-oh@uvex.de

uvex RX App

The virtual companion for prescription safety spectacles

Optimal selection of products – conveniently online

What are the advantages of the different lens types and coatings for innovative uvex prescription safety spectacles? Find the optimum product to meet requirements quickly and easily using the practical uvex RX app.

For example, test at the touch of a button the effect different filters have on the optical properties of spectacles. The app includes striking videos which show the impact tests conducted to determine the stability of lenses. Comprehensive product brochures can also be downloaded for detailed information.

Range of information

Which prescription safety spectacles are best for your requirements? The uvex RX app offers comprehensive information, from innovative product specifications to impact test videos.

Realistic perspective

The uvex RX app provides a realistic experience of vision through varifocal lenses.

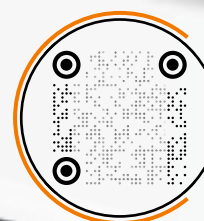

www.uvex-safety.com/uvex_app/uvex-rx



View everything
The uvex RX app makes product selection easier.



Prescription safety spectacles

uvex RX bc plastic frames



6109219
6109203



6109204

uvex RX bc 5503

- plastic frames with classic lens shape
- transparent side shields with integrated brow guard
- good fit with anatomically shaped nose bridge

uvex RX bc 5503

Art. no.	6109219	6109203	6109204
Ref. no.	5503 1300 50/17	5503 1300 54/17	5503 7415 54/17
Lens diameter	50 mm	54 mm	54 mm
Bridge width	17 mm	17 mm	17 mm
Colour	anthracite	anthracite	green, grey
Extras			metal arms with spring hinges
Marking on frame	W 166 FT CE	W 166 FT CE	W 166 FT CE



6108215



6109210

uvex RX bc 5502

- close-fitting plastic frames
- side shields and integrated brow guard frame design
- specially shaped frames provide protection against particles from below
- good fit with anatomically shaped nose bridge
- individually adjustable side arms with four different lengths and adjustable soft-form comfort ear pieces

uvex RX bc 5502

Art. no.	6108215
Ref. no.	5502 1725 56/15
Lens diameter	56 mm
Bridge width	15 mm
Colour	grey
Marking on frame	W 166 F CE

uvex RX bc 5506

- comfortable plastic frame
- side shields and integrated brow guard frame design
- good fit with anatomically shaped nose bridge

uvex RX bc 5506

Art. no.	6109210
Ref. no.	5506 1725 56/18
Lens diameter	56 mm
Bridge width	18 mm
Colour	light grey, translucent
Marking on frame	W 166 F CE

Prescription safety spectacles

uvex RX bc plastic frames



6109252



6109253

uvex RX bc 5523

- round plastic frame with metal arms
- transparent side shields
- good fit with anatomically shaped nose bridge and easily adjustable earpieces

uvex RX bc 5523

Art. no.	6109252	6109253
Ref. no.	5523 1525 49/20	5523 7415 49/20
Lens diameter	49 mm	49 mm
Bridge width	20 mm	20 mm
Colour	grey, translucent	green, grey
Extras	metal arms	metal arms
Marking on frame	W 166 FT CE	W 166 FT CE



Prescription safety spectacles

uvex RX bc metal frames



6109114

uvex RX bc 5109

- modern, rounded metal frame
- transparent side shields
- anatomically adjustable nose pads and ear-pieces ensure an exceptional fit

uvex RX bc 5109	
Art. no.	6109114
Ref. no.	5109 6100 50/19
Lens diameter	50 mm
Bridge width	19 mm
Colour	gold
Marking on frame	W 166 FT CE



6109115

uvex RX bc 5110

- classic, square metal frame
- transparent side shields
- anatomically adjustable nose pads and ear-pieces ensure an exceptional fit

uvex RX bc 5110	
Art. no.	6109115
Ref. no.	5110 1300 55/17
Lens diameter	55 mm
Bridge width	17 mm
Colour	anthracite
Marking on frame	W 166 FT CE



6109116

uvex RX bc 5111

- large metal frame in a retro design featuring a double bridge
- transparent side shields
- anatomically adjustable nose pads and ear-pieces ensure an exceptional fit

uvex RX bc 5111	
Art. no.	6109116
Ref. no.	5111 1800 57/19
Lens diameter	57 mm
Bridge width	19 mm
Colour	silver
Marking on frame	W 166 FT CE

Prescription safety spectacles

uvex RX bc metal frames



uvex RX bc 5102

- fashionable, aviator-style metal frame
- transparent side shields
- anatomically adjustable nose bridge and ear-pieces ensure an exceptional fit

uvex RX bc 5102		
Art. no.	6109100	6109101
Ref. no.	5102 1400 51/20	5102 1400 53/20
Lens diameter	51 mm	53 mm
Bridge width	20 mm	20 mm
Colour	gunmetal, matt	gunmetal, matt
Marking on frame	W 166 FT CE	W 166 FT CE



uvex RX bc 5103

- classic design metal frame with double bridge
- transparent side shields
- anatomically adjustable nose bridge and ear-pieces ensure an exceptional fit

uvex RX bc 5103		
Art. no.	6109104	6109105
Ref. no.	5103 1400 53/17	5103 1400 55/17
Lens diameter	53 mm	55 mm
Bridge width	17 mm	17 mm
Colour	gunmetal, matt	gunmetal, matt
Marking on frame	W 166 FT CE	W 166 FT CE



uvex RX bc 5106

- classic design metal frame
- transparent side shields
- anatomically adjustable nose bridge and ear-pieces ensure an exceptional fit

uvex RX bc 5106		
Art. no.	6109108	6109109
Ref. no.	5106 1400 50/20	5106 1400 52/20
Lens diameter	50 mm	52 mm
Bridge width	20 mm	20 mm
Colour	gunmetal, matt	gunmetal, matt
Marking on frame	W 166 FT CE	W 166 FT CE



uvex RX bc 5108

- slim, expressive metal frame
- transparent side shields
- anatomically adjustable nose bridge and ear-pieces ensure an exceptional fit

uvex RX bc 5108		
Art. no.	6109112	6109113
Ref. no.	5108 3400 54/19	5108 3400 56/19
Lens diameter	54 mm	56 mm
Bridge width	19 mm	19 mm
Colour	steel blue	steel blue
Marking on frame	W 166 FT CE	W 166 FT CE



uvex RX bc 5101

- classic design metal frame with double bridge
- side shields made of wire mesh for good air circulation
- anatomically adjustable nose pads
- arms with sprung hinges and easily adjustable earpieces

uvex RX bc 5101		
Art. no.	6109103	
Ref. no.	5101 1018 56/17	
Lens diameter	56 mm	
Bridge width	17 mm	
Colour	black, silver	
Marking on frame	W 166 FT CE	



Prescription safety spectacles

uvex RX ti



6109400

uvex RX ti 5900

- titanium frame with oval-shaped lenses
- transparent side shields
- frame is lightweight, allergy neutral and corrosion-resistant
- anatomically adjustable nose bridge and ear-pieces ensure an exceptional fit

uvex RX ti 5900	
Art. no.	6109400
Ref. no.	5900 1600 49/20
Lens diameter	49 mm
Bridge width	20 mm
Colour	titanium blue
Marking on frame	W 166 FT CE



6109401

uvex RX ti 5901

- classic design titanium frame
- transparent side shields
- frame is lightweight, allergy neutral and corrosion-resistant
- anatomically adjustable nose bridge and ear-pieces ensure an exceptional fit

uvex RX ti 5901	
Art. no.	6109401
Ref. no.	5901 1600 50/20
Lens diameter	50 mm
Bridge width	20 mm
Colour	titanium blue
Marking on frame	W 166 FT CE



6109402

uvex RX ti 5902

- thin lightweight titanium frame
- transparent side shields
- frame is lightweight, allergy neutral and corrosion-resistant
- anatomically adjustable nose bridge and ear-pieces ensure an exceptional fit

uvex RX ti 5902	
Art. no.	6109402
Ref. no.	5902 1600 52/19
Lens diameter	52 mm
Bridge width	19 mm
Colour	titanium blue
Marking on frame	W 166 FT CE

Prescription safety spectacles

uvex RX cb



6109232

uvex RX cb 5580

- wide fitting plastic frame for the best fit
- frame design with side shields and integrated brow guard
- easily adjustable, soft-form ear pieces for extra comfort
- ideal for individuals with a flat nose bridge, high cheekbones and/or wide temples.
- tested for use with Asian headform 2M, DIS ISO 18526-4:2018

uvex RX cb 5580	
Art. no.	6109232
Ref. no.	5580 3015 57/14
Lens	57 mm
Bridge width	14 mm
Colour	dark blue, grey
Marking on frame	W 166 F CE



6109233

uvex RX cb 5581













- plastic frame with extra wide temple width
- frame design with side shields and integrated brow guard
- easily adjustable, soft-form ear pieces for extra comfort
- ideal for individuals with a flat nose bridge, high cheekbones and/or wide temples.
- tested for use with Asian headform 2M, DIS ISO 18526-4:2018

uvex RX cb 5581	
Art. no.	6109233
Ref. no.	5581 1542 58/14
Lens	58 mm
Bridge width	14 mm
Colour	grey, dark red
Marking on frame	W 166 F CE



Prescription safety spectacles

Lens options uvex RX bc for plastic and metal frames · uvex RX ti · uvex RX cb

Focus type		Lens type	Parameter for centering of the lenses
Description			Specific height Box measure
Single vision			
<ul style="list-style-type: none"> - Correction of visual defect in far, in-between or near distance 		Single vision, Single vision HD	Single vision HD ≥ centre of lens Main line of sight
Certified prescription range			
Comfort lenses			
Nahcomfort - Version with expanded near vision - Ideal for workplace environments of 30 cm to approx. 2 m Distanzcomfort - Calculation of the individual correction for defined distances (1 m, 2 m or 4 m) Single vision Relax - To accommodate the prescription for the lower part of the lens, the prescription is increased by +0.5 of a diopter	  	Nahcomfort Standard, Nahcomfort Optima Versions see page 376 Distanzcomfort Optima Single vision Relax	min. 17 mm Main line of sight min. 17 mm Zero line of sight min. 15 mm Zero line of sight
Certified prescription range			
Bifocal and bifocal comfort			
<ul style="list-style-type: none"> - Correction of visual defect in far and reading distance - Visible segment for near distance - Steplike change from far distance to near distance at the edge of segment - Bifocal: Instantly well-tolerated, visible edge of segment supports orientation >> For bifocal comfort, see page 377	Bifocal  Bifocal Comfort 	Width of segment: 28 mm, curved	
Certified prescription range		Bifocal comfort (CR 39 and PC only) +4.5 to -10.0 dpt. at maximum value cyl. +/- 6.0 dpt. Add. +3.0	
Varifocals			
<ul style="list-style-type: none"> - Correction of visual defect in far, in-between and near distance - Gliding change from far distance to near distance (progressive canal) - The non-visible gliding zone corrects in-between distances 	    Varifocal Optima, Optima HD  Varifocal OR 	Varifocal Standard - Standard area for far distance and near distance - Long, narrow canal of progression Varifocal Pro Work - Large area for far distance - Wide canal of progression - Optimized area for reading distance Varifocal Piccolo - Suitable for flat frames - Large area for far distance and near distance - Shortened canal of progression Varifocal Top One - Very comfortable, large long-distance and close-up field of vision - Wide canal of progression for added convenience - Minimal blur in peripheral vision	min. 23 mm Zero line of sight min. 20 mm Zero line of sight min. 17 mm Zero line of sight min. 19 mm Zero line of sight
Certified prescription range		Varifocal OR (CR 39 and PC only) +4.5 to -10.0 dpt. at maximum value cyl. +/- 6.0 dpt. Add. +3.0	Optima and varifocal OR min. 17 mm Optima HD min. 16 mm (depending on the corridor length) Zero line of sight

- ▶ The overview shows the maximum prescription range which is approved and certified. Depending on the size of the frame and the lens material, further restrictions may apply.
- ▶ Please take into account the specifications relating to the line of sight when determining the vision point.

Material							Extras, optional					
CR 39	HI 1.6	Plastic HI 1.67	PC	Trivex	Silicate Hard glass	Normal AR	Multi AR	Super AR	UV blue protect	Tint	Variomatic brown	
■	■	■	■	■	HD not available	■	■	■	■	■	■	
	incl. hard coating only available with SAR recommended from +/- 4.0 dpt.	incl. hard coating only available with SAR recommended from +/- 6.0 dpt.	incl. hard coating	incl. hard coating		only single vision	only single vision, not for hard glass	■		only HI 1.67 or PC	only Polycarbonate or Trivex	
+10.0 to -10.0 dpt. at maximum value cyl. ± 8.0 dpt.	+12.0 to -13.0 dpt. at maximum value cyl. ± 8.0 dpt.	+13.0 to -14.5 dpt. at maximum value cyl. ± 8.0 dpt.	+9.5 to -12.0 dpt. at maximum value cyl. ± 8.0 dpt.	+8.0 to -11.0 dpt. at maximum value cyl. ± 7.0 dpt.	+7.0 to -6.0 dpt. at maximum value cyl. ± 4.0 dpt.						+7.5 to -8.5 dpt. at maximum value cyl. ± 6.0 dpt.	
Standard/ Optima	only Optima	only Optima	Standard/ Optima	only Optima	–	■	not for hard glass	■	only HI 1.67 or PC	–	–	
■	■	■	■	■	–	■	not for hard glass	■	only HI 1.67 or PC	–	–	
■	■	■	■	■	–	■	not for hard glass	■	only HI 1.67 or PC	–	–	
+9.0 to -7.5 dpt. at maximum value cyl. ± 6.0 dpt.	+8.0 to -8.0 dpt. at maximum value cyl. ± 6.0 dpt.	+9.0 to -10.0 dpt. at maximum value cyl. ± 6.0 dpt.	+9.0 to -6.0 dpt. at maximum value cyl. ± 6.0 dpt.	+7.0 to -6.0 dpt. at maximum value cyl. ± 4.0 dpt.	+6.0 to -4.5 dpt. at maximum value cyl. ± 4.0 dpt.							
■	Bifocal only	–	■	–	Bifocal only	■	not for hard glass	■	–	■	–	
+7.0 to -8.0 dpt. at maximum value cyl. ± 6.0 dpt. Add. +3.0	+8.5 to -10.5 dpt. at maximum value cyl. ± 8.0 dpt. Add. +3.0		+10.0 to -10.0 dpt. at maximum value cyl. ± 6.0 dpt. Add. +3.0		+6.0 to -6.0 dpt. at maximum value cyl. ± 4.0 dpt. Add. +3.0							
■	■	■	■	–	■	■	not for hard glass	■	–	■	only Polycarbonate	
■	■	■	■	■	■	■	not for hard glass	■	only HI 1.67 or PC	■	only Polycarbonate or Trivex	
■	■	■	■	–	■	■	–	■	–	■	only Polycarbonate	
■	■	■	■	–	■	■	not for hard glass	■	only HI 1.67 or PC	■	only Polycarbonate	
■	only Optima and Optima HD	only Optima and Optima HD	■	only Optima and Optima HD	–	only Optima	only Optima not for hard glass	■	only HI 1.67 or PC	■	only Polycarbonate or Trivex	
+6.0 to -10.0 dpt. at maximum value cyl. ± 6.0 dpt. Add. +3.0	+9.5 to -12.0 dpt. at maximum value cyl. ± 6.0 dpt. Add. +3.0	+10.0 to -12.0 dpt. at maximum value cyl. ± 6.0 dpt. Add. +3.0	+9.5 to -10.0 dpt. at maximum value cyl. ± 6.0 dpt. Add. +3.0	+6.0 to -13.0 dpt. at maximum value cyl. ± 6.0 dpt. Add. +3.0	+6.0 to -6.0 dpt. at maximum value cyl. ± 4.0 dpt. Add. +3.0						+7.5 to -10.0 dpt. at maximum value cyl. ± 6.0 dpt. Add. +3.0	



Prescription safety spectacles

uvex RX cd



6109249*



Reflective uvex logo

uvex RX cd 5521

- stylish plastic frame with reflective uvex logo
- transparent lens frame for an unrestricted field of view
- good fit thanks to anatomically shaped nose bridge
- sporty arms made from a combination of soft and hard components to ensure increased comfort and non-slip fit

uvex RX cd 5521	
Art. no.	6109249*
Ref. no.	5521 1813 54/22
Lens diameter	54 mm
Bridge width	22 mm
Colour	silver, anthracite
Marking on frame	W 166 F CE



6109225*



6109226*

uvex RX cd 5514

- close-fitting plastic frame
- transparent side shields and integrated brow guard frame design
- soft, adjustable nose bridge
- easily adjustable soft-form comfort ear pieces

uvex RX cd 5514		
Art. no.	6109225*	6109226*
Ref. no.	5514 1033 53/18	5514 1045 55/18
Lens diameter	53 mm	55 mm
Bridge width	18 mm	18 mm
Colour	black, blue	black, red
Marking on frame	W 166 F CE	W 166 F CE

► Please note the glazing options for uvex RX cd on pages 366/367

Prescription safety spectacles

uvex RX cd



uvex RX cd 5518

- sporty frame design: attractive and durable
- metal-free
- comfortable soft arms (uvex duo component technology), non-slip fit without pressure points
- good fit thanks to anatomically shaped nose bridge

uvex RX cd 5518			
Art. no.	6109230*	6109231*	6109234*
Ref. no.	5518 1341 54/22	5518 5074 54/22	5518 1333 54/22
Lens diameter	54 mm	54 mm	54 mm
Bridge width	22 mm	22 mm	22 mm
Colour	anthracite, red	dark brown, green	anthracite, blue
Marking on frame	W 166 F CE	W 166 F CE	W 166 F CE

► Please note the glazing options for uvex RX cd on pages 366/367



uvex RX cd 5520

- contemporary plastic frame in stylish colours
- good fit thanks to anatomically shaped nose bridge
- translucent lens frame for an unobstructed field of view
- uvex Comfort Sliders allow the side arm length and inclination to be adjusted for a customised fit
- the spectacles can also be worn without uvex Comfort Sliders
- completely metal-free

uvex RX cd 5520		
Art. no.	6109236*	6109246*
Ref. no.	5520 1333 54/18	5520 1344 54/18
Lens diameter	54 mm	54 mm
Bridge width	18 mm	18 mm
Colour	anthracite, blue	anthracite, pink
Marking on frame	W 166 F CE	W 166 F CE

► Please note the glazing options for uvex RX cd on pages 366/367



Accessories for uvex x-fit pro non-prescription safety spectacles are compatible with uvex RX cd 5520 and can be purchased from the uvex online shop.

<https://www.uvex-safety-shop.de/home>

uvex Comfort Slider
Art. no. 9958024
Order unit 1 PC
Contents 5 pairs

uvex mini LED light
Art. no. 9999100
Order unit 1 PC

uvex x-fit pro headband
Art. no. 9958023
Order quantity multiples 5 PC

* These frames fulfil the requirements regarding field of vision (7.1.1) and side protection (7.2.8) in accordance with EN 166:2002 based on Asian headform 2M, as defined in DIS ISO 18526-4:2018.



Prescription safety spectacles

uvex RX cd



6109250

uvex RX cd 5522

- modern plastic frame in a robust design
- translucent frame colour for an unobstructed field of vision
- air vents at the top and side
- soft, adjustable nose bridge
- sporty arms made from a combination of soft and hard components to ensure increased comfort and non-slip fit
- soft, adjustable ear-pieces with metal core

uvex RX cd 5522	
Art. no.	6109250
Ref. no.	5522 2533 58/15
Lens diameter	58 mm
Bridge width	15 mm
Colour	translucent grey, blue
Marking on frame	W 166 F CE

► Please note the glazing options for uvex RX cd on pages 366/367

uvex RX cd 5522 accessories



6118012



6109250 assembled with uvex tight-fit-kit 6118012

uvex RX cd 5522 tight-fit-kit

- set consisting of seal and headband
- seal made of hard and soft components provides a tight fit
- protection against liquids (droplets) – marking 3, in accordance with EN 166
- headband for a more secure fit, can be fitted straight onto the side arms

uvex RX cd 5522 tight-fit-kit	
Art. no.	6118012
Colour	black, anthracite
Seal marking	W 166 3F CE
Compatible with	6109250
Order unit	PC

Prescription safety spectacles

uvex RX cd



6109227



6109228*



6109229*

uvex RX cd 5515

- close-fitting plastic frame
- side shields and integrated brow guard frame design
- soft, adjustable nose bridge
- easily adjustable soft-form comfort ear pieces

uvex RX cd 5515			
Art. no.	6109227	6109228*	6109229*
Ref. no.	5515 1347 51/17	5515 1371 53/17	5515 1342 57/17
Lens diameter	51 mm	53 mm	57 mm
Bridge width	17 mm	17 mm	17 mm
Colour	anthracite, coral	anthracite, petrol	anthracite, dark red
Marking on frame	W 166 F CE	W 166 F CE	W 166 F CE

► Please note the glazing options for uvex RX cd on pages 366/367



6109208
6109209

uvex RX cd 5505

- close-fitting plastic frames
- integrated side shields and brow guard for an exceptionally close fit
- specially shaped frames provide protection against particles from below
- good fit with anatomically shaped nose bridge
- individually adjustable side arm length and angle for a customised fit and adjustable soft-form comfort ear pieces

uvex RX cd 5505		
Art. no.	6109208	6109209
Ref. no.	5505 2900 55/19	5505 2900 57/19
Lens diameter	55 mm	57 mm
Bridge width	19 mm	19 mm
Colour	transparent	transparent
Marking on frame	W 166 F CE	W 166 F CE

► Please note the glazing options for uvex RX cd on pages 366/367



6118000
6118001



uvex RX cd 5505 with uvex RX cd seal

uvex RX cd 5505 seal

- foam seal frame for uvex RX cd 5505 for use when working with dust, chips or fluids
- complies with EN 166 "Protection against liquid droplets and splashes" (category "3")

uvex RX cd 5505 seal		
Art. no.	6118000	6118001
Ref. no.	5505 seal 55/19	5505 seal 57/19
Lens diameter	55 mm	57 mm
Bridge width	19 mm	19 mm
Colour	black	black
Order unit	PC	PC
seal marking	W 166 3 F CE	W 166 3 F CE



Prescription safety spectacles

uvex RX cd 5505 flip-up – special versions



6109237
6109238

uvex RX cd 5505 flip-up, didymium

- flip-up incl. non-prescription didymium lenses
- didymium lenses are special filters with a high absorption rate of 589 nm
- they filter bright yellow sodium flare
- lightweight polycarbonate filter with high mechanical strength
- level of protection 2-2 in accordance with EN 170, mech. strength F in accordance with EN 166
- **Note:** Didymium lenses do not provide increased protection against infrared radiation (IR)

uvex RX cd 5505 flip-up, didymium		
Art. no.	6109237	6109238
Ref. no.	5505 9910 55/19	5505 9910 57/19
Lens diameter	55 mm	57 mm
Bridge width	19 mm	19 mm
Colour	crystal matt, green	crystal matt, green
Features: flip-up		
Lenses	violet PC, didymium	violet PC, didymium
Lens marking	2-2 W 1 F CE	2-2 W 1 F CE
Marking on frame	W 166 F CE	W 166 F CE



6109247
6109248

RX cd 5505 flip-up Didymium plan PC SAR

- plastic frame with flip-up for users who do not require a prescription
- main frame including non-prescription polycarbonate lenses with super anti-reflective coating
- flip-up including non-prescription didymium lenses to filter bright yellow sodium flare (589 nm)

uvex RX cd 5505 flip-up Didymium plan PC SAR		
Art. no.	6109247	6109248
Ref. no.	5505 9051 55/19	5505 9051 57/19
Lens diameter	55 mm	57 mm
Bridge width	19 mm	19 mm
Colour	crystal matt, green	crystal matt, green
Main frame lens	PC transparent, SET	PC transparent, SET
Lens marking	W 1 FT CE	W 1 FT CE
Features: flip-up		
Lenses	violet PC, didymium	violet PC, didymium
Lens marking	2-2 W 1 F CE	2-2 W 1 F CE
Marking on frame	W 166 F CE	W 166 F CE



6109241
6109242

uvex RX cd 5505 flip-up, X-ray protection

- flip-up incl. non-prescription mineral lenses that provide X-ray protection
- the lead equivalent of the protective lenses is 0.75
- protective X-ray lenses are not tested and marked in accordance with EN 166

uvex RX cd 5505 flip-up, X-ray protection		
Art. no.	6109241	6109242
Ref. no.	5505 9975 55/19	5505 9975 57/19
Lens diameter	55 mm	57 mm
Bridge width	19 mm	19 mm
Colour	crystal matt, green	crystal matt, green
Features: flip-up		
Lenses	Leaded mineral glass	Leaded mineral glass
Lens marking	Pbeq 0.75	Pbeq 0.75
Marking on frame	W 166 F CE	W 166 F CE

Prescription safety spectacles

uvex RX cd 5505 flip-up – special versions



6109243
6109244

uvex RX cd 5505 flip-up, CBR65

- flip-up incl. non-prescription CBR65 lenses
- high-contrast, fatigue-free vision
- in workplaces with extremely harsh lighting conditions, blue light is reduced by up to 50%
- slight tint for LED lights, computers and other visual display screens that produce bright, harsh unnatural light with high blue content, or for those working outdoors

uvex RX cd 5505 flip-up, CBR65		
Art. no.	6109243	6109244
Ref. no.	5505 9965 55/19	5505 9965 57/19
Lens diameter	55 mm	57 mm
Bridge width	19 mm	19 mm
Colour	crystal matt, green	crystal matt, green
Features: flip-up		
Lens	PC CBR65	PC CBR65
Lens marking	5-1.4 W 1 FK CE	5-1.4 W 1 FK CE
Marking on frame	W 166 F CE	W 166 F CE



6109239
6109240

uvex RX cd 5505 flip-up, polarising filter

- flip-up incl. non-prescription lenses with polarising filter
- polarising filters only let in radiation from one vibration direction – scattered radiation (e.g. reflection on the surface of water) is suppressed
- particularly suitable for workplaces with a high risk of glare (e.g. offshore, maritime environment, construction industry) and/or highly reflective surfaces
- level of protection 5-3:1 in accordance with EN 172, mech. strength F in accordance with EN 166

uvex RX cd 5505 flip-up, polarising filter		
Art. no.	6109239	6109240
Ref. no.	5505 9911 55/19	5505 9911 57/19
Lens diameter	55 mm	57 mm
Bridge width	19 mm	19 mm
Colour	crystal matt, green	crystal matt, green
Features: flip-up		
Lens	grey PC, polarising	grey PC, polarising
Lens marking	5-3:1 W 1 F CE	5-3:1 W 1 F CE
Marking on frame	W 166 F CE	W 166 F CE



6109218
6109235

uvex RX cd 5505 flip-up welding protection









- flip-up with welding protection lenses, non-prescription
- level of protection 5 (welding), suitable for autogenous welding
- new filter technology with grey-tinted lenses provides reliable protection against UV and infrared radiation as well as ensuring perfect colour recognition
- **Note:** welding protection lenses do not provide sufficient protection against laser beams!
- level of protection 5 in accordance with EN 169 (welding), mech. strength F in accordance with EN 166

uvex RX cd 5505 flip-up welding protection		
Art. no.	6109218	6109235
Ref. no.	5505 9905 55/19	5505 9905 57/19
Lens	55 mm	57 mm
Bridge width	19 mm	19 mm
Colour	black, green	black, green
Features: flip-up		
Lens	PC grey, welding protection 5 uvex infraradur plus	PC grey, welding protection 5 uvex infraradur plus
Lens marking	5 W1 FTK CE	5 W1 FTK CE
Marking on frame	W 166 F CE	W 166 F CE

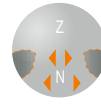
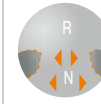

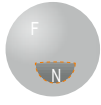
Prescription safety spectacles

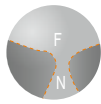
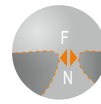
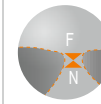
Lens options for uvex RX cd · uvex RX cf 5500 - uvex RX cf 5501

		Lens type	Parameter for centering of the lenses
Description			Specific height Box measure
Single vision			
		Single vision, Single vision HD	Single vision HD min. centre of lens Main line of sight
Prescription range			
Comfort lenses			
			
Nahcomfort Standard	Nahcomfort Optima	Distanzcomfort Optima	Single vision Relax
		Nahcomfort Standard, Nahcomfort Optima Versions see page 376	min. 17 mm Main line of sight
		Distanzcomfort Optima	min. 17 mm Zero line of sight
		Single vision Relax	min. 15 mm Zero line of sight
Prescription range			
Bifocals			
			Width of segment: 28 mm, curved
Bifocal	Bifocal Comfort		
Prescription range		Bifocal Comfort (CR 39 and PC only) +4,5 bis -6,0 dpt. at maximum value cyl. +/- 6,0 dpt. Add. +3,0	
Varifocals			
			
Varifocal Standard	Varifocal Pro Work	Varifocal Piccolo	Varifocal Top One
			Varifocal Optima
			Varifocal Optima HD
			Varifocal OR
		Varifocal Standard	min. 23 mm Zero line of sight
		Varifocal Pro Work	min. 20 mm Zero line of sight
		Varifocal Piccolo	min. 17 mm Zero line of sight
		Varifocal Top One	min. 19 mm Zero line of sight
		Varifocal Optima	min. 17 mm Zero line of sight
		Varifocal Optima HD	min. 16 mm (depending on the corridor length) Zero line of sight
		Varifocal OR	min. 17 mm Zero line of sight
Prescription range		Varifocal OR (CR 39 and PC only) +4,5 bis -6,0 dpt. at maximum value cyl. +/- 6,0 dpt. Add. +3,0	

► In order to ensure optimum vision, uvex compensate the values in accordance to the frame wrap angle (FWA).
The overview below provides information on the lens options for uvex RX cd frames.
Please also ensure the frame fits correctly.

► Please take into account the specifications relating to the line of sight when determining the vision point.

	Material					Extras, optional					
	CR 39	HI 1.6	HI 1.67	PC	Trivex	Normal AR	Multi AR	Super AR	UV blue protect	Tinting	Variomatic brown
	■	■	■	■	■	■	■	■	■	■	■
		incl. hard coating only available with SAR	incl. hard coating only available with SAR	incl. hard coating	incl. hard coating	only single vision	only single vision		only HI 1.67 or PC		only Polycarbonate or Trivex
	+6.0 to -6.0 dpt. at maximum value cyl. ±4.0 dpt.	+6.0 to -6.0 dpt. at maximum value cyl. ±4.0 dpt.	+6.0 to -6.0 dpt. at maximum value cyl. ±4.0 dpt.	+6.0 to -6.0 dpt. at maximum value cyl. ±4.0 dpt.	+6.0 to -6.0 dpt. at maximum value cyl. ±4.0 dpt.						+6.0 to -6.0 dpt. at maximum value cyl. ±4.0 dpt.
	Standard/Optima	only Optima	only Optima	Standard/Optima	only Optima	■	■	■	only Optima, HI 1.67 or PC	—	—
	■	■	■	■	■	■	■	■	only HI 1.67 or PC	—	—
	■	■	■	■	■	■	■	■	only HI 1.67 or PC	—	only Polycarbonate
	+6.0 to -6.0 dpt. at maximum value cyl. ±4.0 dpt.	+6.0 to -6.0 dpt. at maximum value cyl. ±4.0 dpt.	+6.0 to -6.0 dpt. at maximum value cyl. ±4.0 dpt.	+6.0 to -6.0 dpt. at maximum value cyl. ±4.0 dpt.	+6.0 to -6.0 dpt. at maximum value cyl. ±4.0 dpt.						
	■	Bifocal only	—	■	—	■	■	■	—	■	—
	+6.0 to -6.0 dpt. at maximum value cyl. ±4.0 dpt.	+6.0 to -6.0 dpt. at maximum value cyl. ±4.0 dpt.		+6.0 to -6.0 dpt. at maximum value cyl. ±4.0 dpt.							
	■	■	■	■	—	■	■	■	—	■	only Polycarbonate
	■	■	■	■	■	■	■	■	only, HI 1.67 or PC	■	only Polycarbonate or Trivex
	■	■	■	■	—	■	—	■	—	■	only Polycarbonate
	■	■	■	■	—	■	■	■	only, HI 1.67 or PC	■	only Polycarbonate
	■	■	■	■	■	■	■	■	only, HI 1.67 or PC	■	only Polycarbonate or Trivex
	■	■	■	■	■	only Optima	only Optima	■	only, HI 1.67 or PC	■	only Polycarbonate or Trivex
	■	—	—	■	—	■	■	■	—	■	—
	+6.0 to -6.0 dpt. at maximum value cyl. ±4.0 dpt.	+6.0 to -6.0 dpt. at maximum value cyl. ±4.0 dpt.	+6.0 to -6.0 dpt. at maximum value cyl. ±4.0 dpt.	+6.0 to -6.0 dpt. at maximum value cyl. ±4.0 dpt.	+6.0 to -6.0 dpt. at maximum value cyl. ±4.0 dpt.						+6.0 to -6.0 dpt. at maximum value cyl. ±4.0 dpt.



uvex RX sp
Lifestyle at work

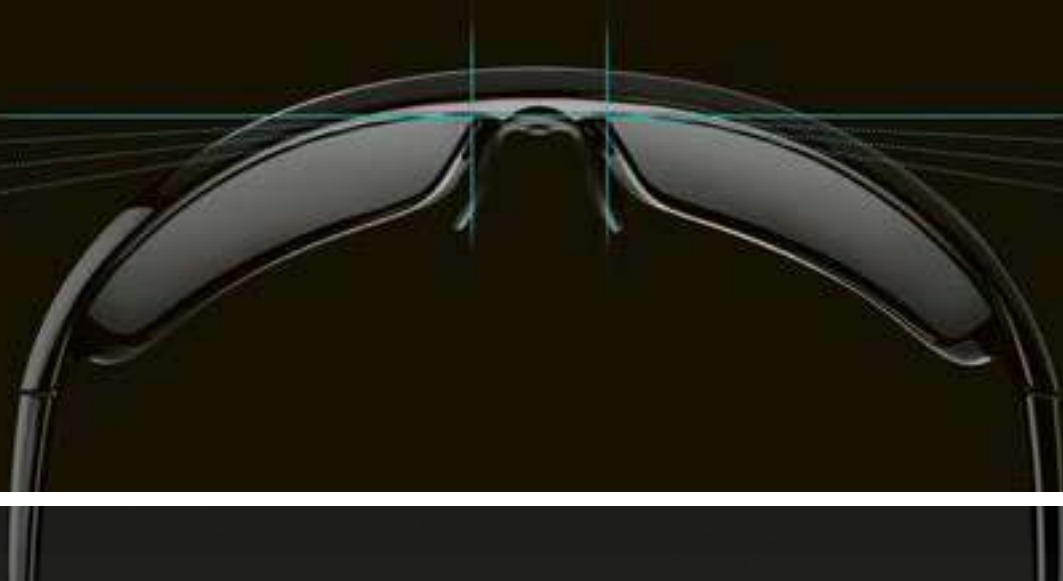

uvex RX sp frames

Make a statement with the uvex RX sp collection which stands out due to its sporty design and appealing frame colour combinations . All protection functions are fully integrated into the frame design requiring no separate side guards which is commonly the case with conventional protective spectacles.

The wraparound design offers the perfect fit and maximum protection thanks to its wide side arms and curvature of the lens. As with all uvex models, only the highest quality plastics are used in its protection.

uvex anatomic sport lens

we only use lenses with a base curve that is identical to the curvature of the frame.
prescription values are recalculated based on the angle of the lenses and taken into account during the glazing process.

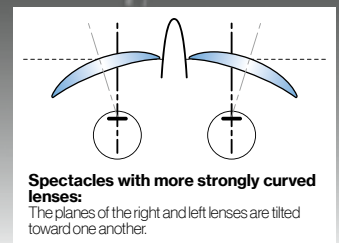
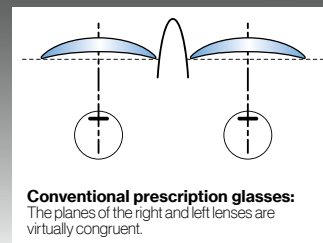

uvex RX sp 5510

- sporty, plastic “wraparound” design with curved lenses and anatomic sport glazing
- side shield and integrated brow guard frame design
- good fit with anatomically shaped soft nose bridge
- sporty arms with a combination of soft and hard components ensure increased comfort and non-slip fit

uvex RX sp 5510		
Art. no.	6109216	6109217
Ref. no.	5510 1217 62/17	5510 1248 62/17
Lens diameter	62 mm	62 mm
Bridge width	17 mm	17 mm
Colour	matt black, light grey	matt black, orange
Marking on frame	W 166 F CE	W 166 F CE

► Please note the glazing options for uvex RX sp on pages 372/373

Prescription safety spectacles

uvex RX sp



6109222

uvex RX sp 5513

- sporty, plastic “wraparound” design with large lenses and anatomic sport glazing
- side shield and integrated brow guard frame design
- good fit due to anatomically shaped soft nose bridge
- sporty arms with a combination of soft and hard components ensure increased comfort and non-slip fit

uvex RX sp 5513	
Art. no.	6109222
Ref. no.	5513 1577 62/16
Lens diameter	62 mm
Bridge width	16 mm
Colour	grey, light green
Marking on frame	W 166 F CE

► Please note the glazing options for uvex RX sp on pages 372/373



6109220

uvex RX sp 5512

- sporty, plastic “wraparound” design with curved lenses and anatomic sport glazing
- uvex tight-fit-kit consisting of headband and foam material available
- side shield and integrated brow guard frame design
- the arms can be replaced with a headband for a more secure fit when working in extreme conditions
- the foam material guarantees a close and firm fit.
- very good fit with anatomically adjustable, soft nose bridge
- sporty side arms with a combination of soft and hard components ensure increased comfort and non-slip fit

Applications in combination with the tight-fit-kit:

- working in extreme situations, such as overhead or in confined spaces
- working with fluids (drops) or chips and dust
- complies with EN 166 “Protection against liquid droplets and splashes” (category “3”)

uvex RX sp 5512		
Art. no.	6109220	6109221
Ref. no.	5512 5573 65/16	5512 1348 65/16
Lens diameter	65 mm	65 mm
Bridge width	16 mm	16 mm
Colour	brown, olive	anthracite, orange
Marking on frame	W 166 F CE	W 166 F CE

uvex RX sp 5512 tight-fit-kit		
Art. no.	6118004	6118005
Colour	brown, olive	anthracite, orange
Order unit	PC	PC
tight-fit-kit marking	W 166 3 F CE	W 166 3 F CE

► Please note the glazing options for uvex RX sp on pages 372/373



6118004



6109220 assembled with uvex RX sp 5512 tight-fit-kit 6118004



6118005



6109221 assembled with uvex RX sp 5512 tight-fit-kit 6118005



Prescription safety spectacles

uvex RX cf



6108200

uvex RX cf 5500

- spectacles with all-round protection
- fixed RX insert for your individual prescription
- meets the requirements for additional markings 3 (liquids, droplets) and 4 (coarse dust)
- perfect fit providing reliable protection: The side arms can be adjusted to a variety of different lengths, allowing the glasses to be adapted to suit all facial shapes
- flexible soft components adapt to the wearer's face contours

uvex RX cf 5500	
Art. no.	6108200
RX insert lens diameter	48 mm
RX insert bridge width	20 mm
Colour	blue, grey
Marking on frame	W 166 34 F CE
Lenses	PC clear
Lens marking	2C-1,2 W 1 FKN

► Please note the glazing options for uvex RX cd on pages 366/367



6108201

uvex RX cf 5501

- small goggles with fixed RX insert to suit your individual prescription
- meets the requirements for additional markings 3 (liquids, droplets) and 4 (coarse dust)
- highly compatible with other PPE
- low-volume frame design
- indirect ventilation

uvex RX cf 5501	
Art. no.	6108201
RX insert lens diameter	48 mm
RX insert bridge width	20 mm
Colour	black, grey
Marking on frame	W 166 34 B CE
Lenses	PC clear
Lens marking	2C-1,2 W 1 FKN

► Please note the glazing options for uvex RX cd on pages 366/367

uvex RX cf 9501
goggle with direct prescription lenses



Recommended use/glazing

Lens material: PC*

- Workplaces with a high risk of mechanical hazards
- such as metal-cutting shaping, turning, grinding and milling
- Mechanical strength "B", 120 m/s

Lens material: Trivex

- Workplaces with a high risk of chemical hazards
- such as laboratories and those handling small quantities of chemicals
- Mechanical strength "F", 45 m/s

uvex RX cf 9501

- goggles with custom prescription
- direct prescription lenses provide exceptional optical quality without aberrations or loss of light
- comfortable TPE frame, stays comfy even when worn for longer periods
- high level of mechanical strength ("B", 120 m/s)
- meets the requirements for additional markings 3 (liquids, droplets) and 4 (coarse dust)

uvex RX cf 9501	
Art. no.	6109501
Ref. no.	9501 1333 61/14
Lens diameter	61 mm
Bridge width	14 mm
Colour	anthracite, blue
Marking on frame	W 166 34 B CE

► Please note the glazing options for uvex RX cf 9501 on pages 372/373



Direct prescription lenses

Prescription safety lenses are inserted directly into the goggle frame according to the individual prescription strength.



Sophisticated ventilation

Direct and indirect air vents ensure optimum protection and excellent ventilation for "eye zone" comfort.



Flexible headband clip



















The flexible headband clip allows the goggle to adjust to different facial shapes for a customised fit. The comfortable fabric headband keeps the uvex RX cf 9501 securely in place.



For further information on lens materials and models, information can be found on pages 374 - 380

Prescription safety spectacles

Lens options for uvex RX sp models · Special lenses for uvex RX cf 9501

uvex RX sp 5510		Important note	Lens type	Parameter for centering of the lenses	
Description				Specific height Box measure	
	Single vision 	for uvex RX sp 5510: Minimum PD \geq 32.0 mm Fitting height \geq centre of lens	Single vision Single vision HD	Main line of sight	
	Comfort lenses    Nahcomfort Optima Distanzcomfort Optima Single vision Relax	for uvex RX sp 5510: Minimum PD \geq 32.0 mm Fitting height \geq centre of lens	Nahcomfort Optima Distanzcomfort Optima Single vision Relax	min. 17 mm Main line of sight min. 17 mm Zero line of sight min. 15 mm Zero line of sight	
	Varifocals   Varifocal Pro Work Varifocal Optima Varifocal Optima HD	for uvex RX sp 5510: Minimum PD \geq 32.0 mm Fitting height \geq centre of lens	Varifocal Pro Work Varifocal Optima Varifocal Optima HD	min. 20 mm Zero line of sight min. 17 mm Zero line of sight min. 16 mm Zero line of sight	
	Prescription range				
	uvex RX sp 5512 · uvex RX sp 5513				
	 	Single vision 	Minimum PD \geq 32.0 mm Fitting height \geq centre of lens	Single vision Single vision HD	Main line of sight
		Comfort lenses    Nahcomfort Optima Distanzcomfort Optima Single vision Relax	Minimum PD \geq 32.0 mm Fitting height \geq centre of lens	Nahcomfort Optima Distanzcomfort Optima Single vision Relax	min. 17 mm Main line of sight min. 17 mm Zero line of sight min. 15 mm Zero line of sight
		Varifocals   Varifocal Pro Work Varifocal Optima Varifocal Optima HD	Minimum PD \geq 32.0 mm Fitting height \geq centre of lens	Varifocal Pro Work Varifocal Optima Varifocal Optima HD	min. 20 mm Zero line of sight min. 17 mm Zero line of sight min. 16 mm Zero line of sight
		Prescription range			
		uvex RX cf 9501			
Description		Important note	Lens type	Parameter for centering of the lenses	
	Single vision 	When using PC or PC+ Minimum PD \geq 32.0 mm When using Trivex Minimum PD \geq 34.0 mm	Single vision Single vision HD	Main line of sight	
	Varifocals   Varifocal Pro Work Varifocal Optima Varifocal Optima HD	When using PC or PC+ Minimum PD \geq 32.0 mm When using Trivex Minimum PD \geq 34.0 mm	Varifocal Pro Work Varifocal Optima Varifocal Optima HD	min. 20 mm Zero line of sight min. 17 mm Zero line of sight min. 16 mm Zero line of sight	
	Prescription range				

- ▶ In order to ensure optimum vision, uvex only uses the special uvex anatomic sport glazing. The overview below provides information on the lens options for uvex RX sp frames and uvex RX goggle. Please also ensure the frame fits correctly.
- ▶ Please take into account the specifications relating to the line of sight when determining the vision point.

Material						Extras, optional					
CR 39	HI 1.6	Plastic HI 1.67	PC	Trivex	Normal AR	Multi AR	Super AR	UV blue protect	Tint	Variomatic brown	
■	■	■	■	■	■	■	■	■	■	■	
	incl. hard coating only available with SAR	incl. hard coating only available with SAR	incl. hard coating	incl. hard coating				only HI 1.67 or PC		only Polycarbonate or Trivex	
■	■	■	■	—	■	■	■	only HI 1.67 or PC	—	—	
■	■	■	■	—	■	■	■	only HI 1.67 or PC	—	—	
■	■	■	■	—	■	■	■	only HI 1.67 or PC	—	—	
■	■	■	■	■	■	■	■	only HI 1.67 or PC	■	only Polycarbonate or Trivex	
■	■	■	■	■	■	■	■	only HI 1.67 or PC	■	only Polycarbonate or Trivex	
■	■	■	■	■	■	■	■	only HI 1.67 or PC	■	only Polycarbonate or Trivex	
+ 5.0 to - 5.0 dpt. at maximum value cyl. ±2.0 dpt.	+ 5.0 to - 5.0 dpt. at maximum value cyl. ±2.0 dpt.	+ 5.0 to - 5.0 dpt. at maximum value cyl. ±2.0 dpt.	+ 5.0 to - 5.0 dpt. at maximum value cyl. ±2.0 dpt.	+ 5.0 to - 5.0 dpt. at maximum value cyl. ±2.0 dpt.						+ 5.0 to - 5.0 dpt. at maximum value cyl. ±2.0 dpt.	
■	■	■	■	■	■	■	■	■	■	■	
	incl. hard coating	incl. hard coating only available with SAR	incl. hard coating	incl. hard coating				only HI 1.67 or PC		only Polycarbonate or Trivex	
■	■	■	■	—	■	■	■	only HI 1.67 or PC	—	—	
■	■	■	■	—	■	■	■	only HI 1.67 or PC	—	—	
■	■	■	■	—	■	■	■	only HI 1.67 or PC	—	—	
■	■	■	■	■	■	■	■	only HI 1.67 or PC	■	only Polycarbonate or Trivex	
■	■	■	■	■	■	■	■	only HI 1.67 or PC	■	only Polycarbonate or Trivex	
■	■	■	■	■	■	■	■	only HI 1.67 or PC	■	only Polycarbonate or Trivex	
+ 3.5 to - 3.5 dpt. at maximum value cyl. ±2.0 dpt.	+ 3.5 to - 3.5 dpt. at maximum value cyl. ±2.0 dpt.	+ 3.5 to - 3.5 dpt. at maximum value cyl. ±2.0 dpt.	+ 3.5 to - 3.5 dpt. at maximum value cyl. ±2.0 dpt.	+ 3.5 to - 3.5 dpt. at maximum value cyl. ±2.0 dpt.						+ 3.5 to - 3.5 dpt. at maximum value cyl. ±2.0 dpt.	
Material						Extras, optional					
CR 39	HI 1.6	Plastic HI 1.67	PC/PC ⁺	Trivex	Normal AR	Multi AR	Super AR	UV blue protect	Tint	Variomatic brown	
—	—	—	■	■	■	■	■	■	■	■	
	incl. hard coating only available with SAR	incl. hard coating only available with SAR	incl. hard coating	incl. hard coating				only HI 1.67 or PC		only Polycarbonate or Trivex	
—	—	—	■	■	■	■	■	only HI 1.67 or PC	■	only Polycarbonate or Trivex	
—	—	—	■	■	■	■	■	only HI 1.67 or PC	■	only Polycarbonate or Trivex	
—	—	—	■	■	■	■	■	only HI 1.67 or PC	■	only Polycarbonate or Trivex	
			+ 3.5 to - 3.50 dpt. at maximum value cyl. ±2.0 dpt.	+ 3.5 to - 3.50 dpt. at maximum value cyl. ±2.0 dpt.						+ 3.5 to - 3.5 dpt. at maximum value cyl. ±2.0 dpt.	



Prescription safety spectacles

Certification and marking

Certification

Individually manufactured uvex prescription safety spectacles are tested and certified by independent testing institutes at regular intervals according to the requirements of EN 166.



Marking of lenses in accordance with EN 166

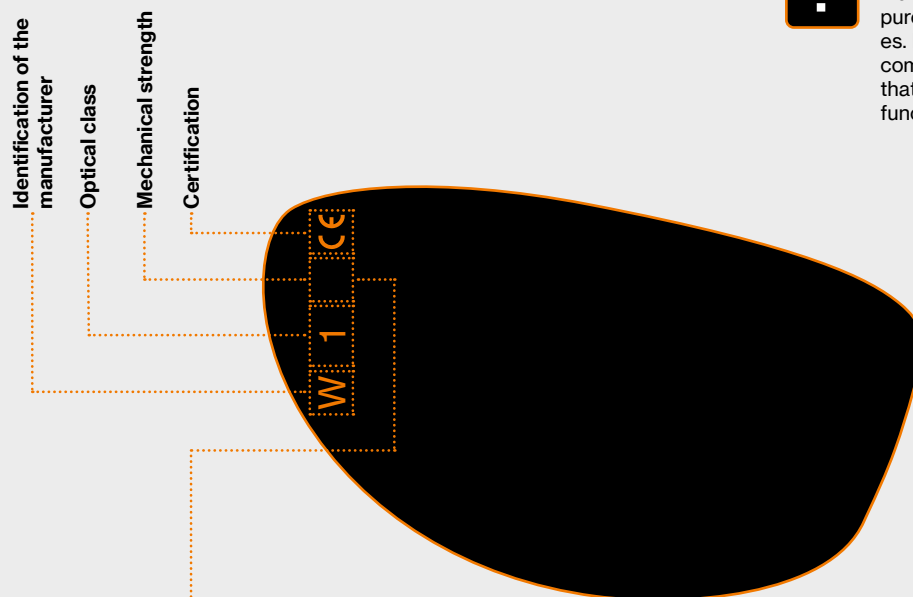

Note: Due to the mandatory marking, it is not possible to purchase frames without lenses. Please do not modify the completed spectacles in a way that reduces their protective function.

- S** **Increased robustness:** Ball bearing drop test, Dropping a ball bearing (44 g) against the lens from a height of 1.30 m
- F** **Impact-resistant, low energy:** Firing a ball bearing (0.88 g) against the lens, impact speed 45 m/s (±162 km/h)
- B** **Impact-resistant, medium energy:** Firing a ball bearing (0.88 g) against the lens, impact speed 120 m/s (±432 km/h)
- T** Optional requirements in accordance with EN 166 (extract): **Tested in extreme temperatures (-5°C, +55°C)**, this marking is always in combination with mechanical strength (for example, FT)

Prescription safety spectacles

Certification and marking

Marking

- frame and lenses are permanently marked
- if the markings on the lens and frame are different, the lower mechanical strength applies to the entire eye protection device
- according to the PPE regulation, uvex prescription safety spectacles must be marked with the factory symbol and production date: ☐ MM/YYYY



Marking in accordance with EN 166 on the lens and inside of the frame

Marking of the frame in accordance with EN 166

<p>Identification of the manufacturer</p> <p>W</p>	<p>Number of the EN standard</p> <p>166</p>	<p>Field(s) of use</p>	<p>Mechanical strength</p>	<p>Certification</p> <p>CE</p>
<p>Additional requirements in accordance with EN 166 (extract):</p> <p>Resistance to liquids (droplets, spray)</p>		<p>3</p>	<p>S</p>	<p>Increased robustness: Ball bearing drop test, Dropping a ball bearing (44 g) against the frame from a height of 1.30 m</p>
<p>Additional requirements in accordance with EN 166 (extract):</p> <p>Resistance to coarse dust (grain size > 5 µm)</p>		<p>4</p>	<p>F</p>	<p>Impact-resistant, low energy: Firing a ball bearing (0.88 g) against the frame, impact speed 45 m/s (±162 km/h)</p>
<p>No number = general use: Non-specific mechanical risks, risks due to UV and/or visible IR radiation</p>		<p></p>	<p>B</p>	<p>Impact-resistant, medium energy: Firing a ball bearing (0.88 g) against the frame, impact speed 120 m/s (±432 km/h)</p>
		<p></p>	<p>T</p>	<p>Optional requirements in accordance with EN 166 (extract): tested in extreme temperatures (-5°C, +55°C), this labelling is always in combination with mechanical strength (for example, FT)</p>



Prescription safety spectacles

Focus types

Single vision lenses

Single vision

- defective vision caused by long-sightedness or short-sightedness is corrected

Single vision HD – the ultimate in customisation!

- free-form single-vision lens
- individual parameters such as cornea vertex distance, frame wrap angle and inclination are taken into account for production purposes.
- calculation of dioptres to an accuracy of one hundredth



Comfort lenses

- ideal for use at workstations with monitors
- comfort lenses relieve the eye when looking at objects close up and at intermediate distances thanks to their seamless correction areas
- comfort lenses are a good alternative if the prescription safety eyewear is only needed at workstations and distance vision (> 5 m distance) is not necessary.



Nahcomfort Standard, Nahcomfort Optima

- perfect solution for working distances between 30 cm and approx. 2 m
- the medium range of the lens surface is determined by the degression chosen and is designed for a distance of approx. 60 cm to 80 cm
- three versions are available, depending on the required reading addition (optional based on the age of the wearer)
- all that is needed to place an order are details of the close-range values and the required design (type A, B, C)
- when ordering the Nahcomfort Optima option, the inner surface of the raw lenses is calculated and manufactured, taking into account the correction, the glass curve and the distance between the eyes

Type A	Type B	Type C
Degression** 0.75 dpt	Degression** 1.25 dpt	Degression** 1.75 dpt
Addition < 1.5 dpt.	Addition 1.5 to 2.25 dpt.	Addition > 2.25 dpt.
< 50 years	50 to 55 years	> 55 years

** Degression: Correction reduced, based on the close-range value!

Note:

Ideal for use in VDU spectacles. About 60% of degression is active at the centring cross, so the recommended adjustment applies on the main line of sight.

Distanzcomfort Optima

- perfect solution for working distances between 30 cm and around 1 m, 2 m or 4 m
- by specifying the viewing distance that is required at the workstation, the correction areas will be calculated individually
- all that is needed to place an order are details of the distance and close-range values (addition), the maximum viewing distance (one, two or four meters) as well as the centering parameters (pupillary distance and specific height)
- recommended adjustment: zero line of sight, distance values and addition

Single Vision Relax

- this type of lens is targeted at people over the age of 30
- an invisibly integrated change to the correction value of +0.5 dpt. in the lower area of the lens eases the strain on the eye when looking at near distances (accommodation support)
- the distance correction remains unchanged
- all that is needed to place an order the details of distance values and centring parameters (pupillary distance and specific height)
- we recommend Single Vision Relax lenses for professionals who use mobile devices (notebook, tablet, smartphone etc.) for their daily work

Prescription safety spectacles

Focus types



Bifocal lenses

Bifocal

- visibly ground segment for near vision ('reading field')
- instant wearer acceptance as visible edge helps eyes to adjust
- intermediate ranges are not corrected



Bifocal Comfort

- free-form bifocal lens with a rounded, blended near-vision area for a more aesthetic appearance
- instant wearer acceptance due to soft transition to the near-vision area
- handled in the same way as conventional bifocal lenses
- intermediate ranges are not corrected



Varifocal lenses

- gradual transition from distance to near vision, known as the progression zone
- the invisible progression zone also corrects intermediate distances
- clear vision at all viewing distances
- may require an initial adjustment phase

Varifocal Optima HD – the ultimate in customisation!

- free-form varifocal lens taking into account individual parameters such as cornea vertex distance, frame wrap angle and inclination
- calculation of dioptres to an accuracy of one hundredth



Varifocal OR

- free-form varifocal lens with a blended near-vision area in the upper section to make overhead work easier
- selection of the addition in the upper near-vision area (depending on the working distance)
- the addition in the upper near-vision segment depends on the addition in the progressive part of the lens
- the following can be selected:
 - type A: addition distribution: 100% bottom and 100% top
 - type B: addition distribution: 100% in the progressive near-vision area and 60% in the blended near-vision area
- type B example: addition: bottom 2.0 dpt. /top 1.2 dpt.



Prescription safety spectacles

Lens material



Polycarbonate

- mechanical strength 'F' (45 m/sec)
- organic material with very high breaking strength
- only partially chemical-resistant
- PC⁺ – polycarbonate with increased centre thickness and mechanical strength 'B' (120 m/sec), especially for the uvex RX goggle
- PC and PC⁺: Identification code: 2C-1.2 as per EN 170

Trivex™

- mechanical strength 'F' (45 m/sec)
- best all-round lens material
- excellent resistance to cleaning agents, oils and cosmetics and good scratch resistance
- lightweight, suitable for even higher prescription values

CR39, modified (plastic)

- mechanical strength 'S' (ball drop test)
- lightweight organic material suitable for chemicals and painting
- good scratch resistance due to hard coating (optional)

HI (high index)

Organic lenses with high refractive index – 1.6 or 1.67

- mechanical strength 'S' (ball drop test)
- organic material suitable for chemicals and painting
- the lens is thinner and more aesthetically pleasing

HI 1.6 recommended for a prescription > +/-4.0 dpt.
HI 1.67 recommended for a prescription > +/-6.0 dpt.

Hard glass, modified

(crown glass, silicate, mineral glass, glass)

- mechanical strength 'S' (ball drop test)
- highly scratch-resistant surface suitable for working with chemicals and paints
- heavy, not recommended for prescription values greater than +/-4.0 dpt.
- spark penetration when welding or grinding

UV blue protect

A special absorber has been added to the lens material that completely filters out UV rays and reduces the blue light content.

- the lenses absorb UV radiation up to 400 nm at 100%, filter short-wave blue light until 410 nm almost completely and reduce the range from 410 nm to 420 nm around 86%.
- uvex UV blue protect lenses enhance contrast and effectively prevent signs of fatigue and age-related macular degeneration (AMD)
- UV blue protect is optionally available for polycarbonate (PC) lenses and HI 1.67

- the mechanical strength of the lenses is guaranteed – clear lenses with UV blue protect are marked 2C-1.2 according to EN 170

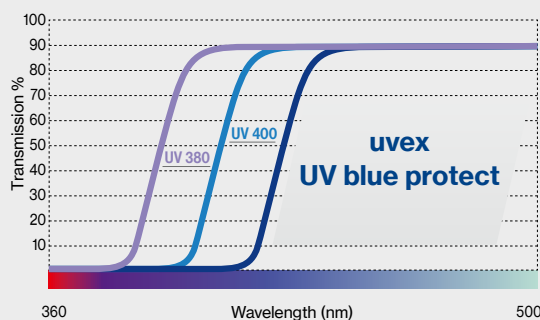

Prescription safety spectacles

Finishes

Anti-reflective coating

Anti-reflective coating is applied to the inside and outside of lenses by means of vapour deposition. It significantly reduces reflections on the surfaces. It offers a cosmetic advantage and increases light transmission.

Three qualities are available:

- normal anti-reflective coating
- multiple anti-reflective coating
- super anti-reflective coating

Normal anti-reflective coating	Super anti-reflective coating
Good reflection reduction	Maximum reflection reduction
Metal oxide is applied once to each surface	Metal oxide is applied several times to each surface
Residual reflection \approx 4%	Residual reflection $<$ 2%



Scratch-resistant coating

To guarantee an ideal surface hardness, all our plastic lenses are given a hard coating (optional for CR 39).



Tint

Tinted lenses provide effective protection against glare in areas with high light intensity (for example, sunlight)

Constant tinting

- available in brown and grey
- tinting levels: 15%, 25%, 65%, 75%

Variable tinting – Variomatic™

- lenses tint automatically depending on the UV radiation and temperature
- tinting of between approx. 8% and 80%, in brown
- available as prescription safety spectacles in polycarbonate and Trivex™

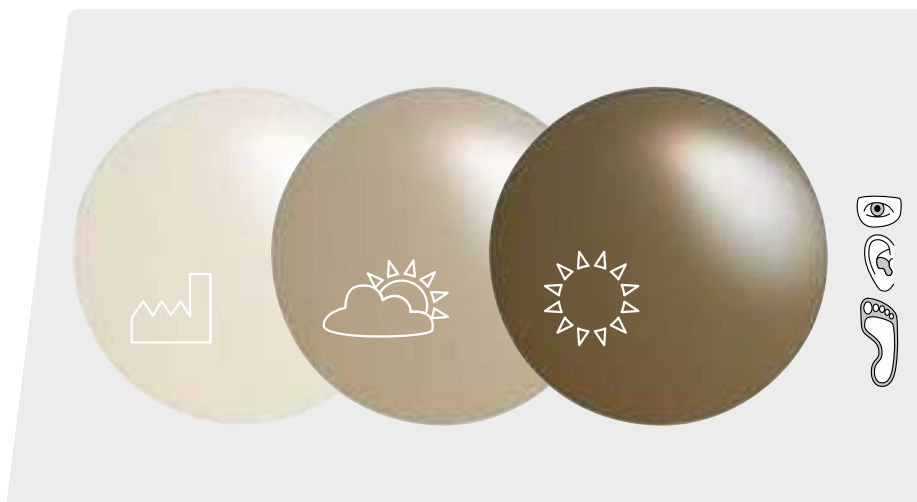

Prescription safety spectacles

Special lenses

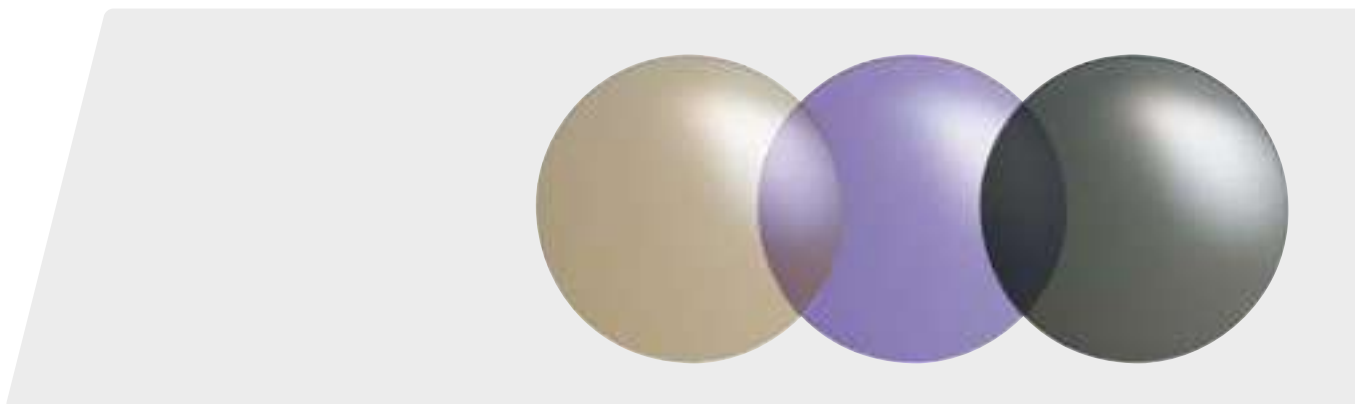

Special lenses for special requirements are available in combination with our RX cd 5505 flip-up models. The flip-up is fitted with non-prescription special lenses. The main frame is fitted with individual prescription safety lenses

Didymium

- special filter with high absorption at 589 nm, resulting in characteristic violet colour
- the 'bright yellow sodium flare' is filtered out
- lightweight polycarbonate filter with mechanical strength 'F' (45 m/s)
- level of protection 2-2 in accordance with EN 170
- marking: 2-2 W 1 F CE
- note: Didymium lenses do not provide increased protection against infrared radiation (IR)

Areas of application:

Glass production, glass processing, e.g. glass blowing

X-ray protection

- mineral lenses that provide protection against X-rays
- the lead equivalent of the protective lenses is 0.75
- the lead content in the lenses gives them their characteristic grey colour (approx. 10% colouring)
- marking: Pbeq 0.75
- note: Protective X-ray lenses are not tested and marked in accordance with EN 166

Areas of application:

e.g. crack and material testing

Welding protection

- welding protection level 5 in accordance with EN 169
- grey-tinted polycarbonate filters for reliable protection against UV and infrared radiation with mechanical strength 'F' (45 m/s)
- perfect colour perception during the welding process
- marking: 5 W 1 FTK CE
- note: Welding protection lenses do not provide sufficient protection against laser beams!

Areas of application:

Autogenous welding

CBR65

- contrast enhancement – For better contrast and comfortable vision, even in diffused light
- Blue light reduction – Blue light is reduced by up to 50% in extremely bright workplaces
- Relaxed vision – Reduced eye fatigue, even during longer periods of use
- 65% transmission – Slight tint for optimal protection against glare for high visual standards even in extremely bright, artificial light as well as natural light
- lightweight polycarbonate filter with mechanical strength 'F' (45 m/s)
- marking: 5-1.4 W 1 FK CE

Areas of application:

Workplaces with high visual standards in very bright artificial light or natural light

Polarisation filter

- polarising filters only let in radiation from one vibration direction – scattered radiation (e.g. reflection on the surface of water) is suppressed
- lightweight polycarbonate filter with mechanical strength 'F' (45 m/s)
- marking: 5-3.1 W 1 F CE

Areas of application:

- particularly suitable for workplaces with a high risk of glare and/or highly reflective surfaces
- offshore, maritime environment, construction industry

uvex i-3 add

Perfect vision in every situation

Optimum protective eyewear means improved, safe vision.

uvex i-3 add safety spectacles have invisible integrated dioptr correction for near vision. Strain on the eyes is effectively reduced (e.g. when reading) and the patented lens technology ensures an instant high level of compatibility for wearers. At the same time, the uvex i-3 add spectacles provide secure protection and optimal comfort.



Variable side arm inclination

The 5-position side arm inclination allows individual adjustment and optimum coverage of the eyes.



Addition

Two models are available for individualised correction of near vision. (+1.0 dpt. and +2.0 dpt.)

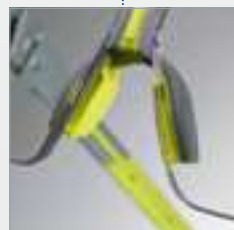

Flexible nose loops

The extremely soft adjustable Softflex nose loops ensure a secure fit and can be individually adapted to sit comfortably on the nose.

uvex supervision excellence

The uvex supervision excellence coating guarantees extreme scratch resistance on the outside and permanent anti-fogging properties on the inside.

MADE IN GERMANY

Patent no.: DE 10 2012 207 384

Perfection in every detail

The patented lens technology makes it possible to integrate two progression zones for near vision on the inside of the duospherical single lens safety spectacles. The correction strength at the bottom of the lenses is +1.0 or +2.0, depending on the model. A distinctive feature and unique selling point is that the patented manufacturing technology means the front area and consequently the base curve of the lenses are not altered.

This combines extremely good coverage and fit, all the way to the edge, together with the benefits of a progressive lens on the inside area. A further benefit is that the progressive zone is not visible and that these spectacles comply with all standards of EN norms that are relevant to safety.

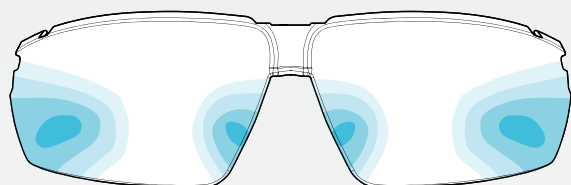

optical lens designed by
optiswiss
original since 1937

Progression zones

This diagram of the lenses shows the large zone that does not feature any optical correction. The transparent, integrated optical correction starts in the region of the middle and the strength increases gradually towards the lower edge of the lenses. The correction strength of the spectacles is +1.0 or +2.0, depending on the model. The free-form lens is manufactured in accordance with standard parameters and designed for a distance of approximately 64 mm between the eyes. These safety spectacles do not permanently replace prescription safety spectacles.

uvex i-3 add

	uvex i-3 add 1.0	uvex i-3 add 2.0
Art. no.	6108210	6108211
Frame	anthracite, lime	anthracite, lime
	W 166 FT CE	W 166 FT CE
Lens	PC clear	PC clear
	UV 400	UV 400
	2C-1.2 W 1 FTKN CE	2C-1.2 W 1 FTKN CE
	uvex supervision excellence	uvex supervision excellence
Strength	1.0 dpt.	2.0 dpt.
Order unit	PC	PC



Including soft spectacles case with microfiber cloth



VDU spectacles

Individual eye protection at the screen

**MADE FOR
YOUR EYES**
MADE IN **UVEX**



uvex VDU spectacles are specially designed for working at a screen, enabling problem-free vision at a computer workstation.

The special feature of VDU spectacles is the distance for which they have been optimised. Normally, the lens is designed for a viewing distance of approximately 30 cm (reading distance) to correct presbyopia. A screen is usually about 50 cm – 80 cm away from the human eye.

To be able to focus continuously at different distances, spectacle wearers are forced to adopt an unnatural head position and body posture. This can lead to a variety of posture-related symptoms, such as overexertion of the

shoulder and neck muscles, fatigue symptoms or headaches. For most people who wear reading glasses or varifocals in their everyday lives, VDU spectacles are recommended if the main activity in their job requires viewing a computer screen and safety spectacles are not mandatory in the workplace.

uvex offers different lens materials, focus types and frames for VDU spectacles. The 'Made in uvex' quality system guarantees the best design from an optical and processing technology perspective. All materials used are free from harmful substances and are regularly inspected.

The collection

uvex offers different frames for VDU spectacles. Numerous models are available as metal, plastic or titanium frames.

Metal frames



Plastic frames



Titanium frames



VDU spectacles

Individual eye protection at the screen

uvex as a partner for individual VDU spectacles

The position of the screen, keyboard and documents in offices is a special visual requirement. uvex offers individual solutions in the area of VDU spectacles. Decades of experience and innovative technologies form the basis for the

uvex products, which are manufactured according to the highest production standards. In addition to symptom-free vision at work, uvex also guarantees maximum comfort and quality. Employees will be happy to wear those VDU spectacles which fit perfectly and provide reliable support.

Our service – your benefits

uvex offers maximum service with maximum flexibility. Our specialists are happy to advise you with regard to professional and flexible solutions, tailored to the individual requirements of your company.

Our wide uvex collection enables us to find VDU spectacles for each of your employees.



uvex experts:

- on-site service from qualified opticians and master opticians
- qualified advisers in uvex customer service
- comprehensive uvex optical service partner network in Germany, Austria and Switzerland, as well as in other European countries



uvex flexibility:

- product consultation and adaptations on request.
- appointments are also possible during the early, late or night shift
- uvex online appointment tool optimises planning



uvex expertise:

- decades of experience in optics and continuous development of products
- training courses/practical seminars for your employees (e.g. company doctors, occupational safety specialists)
- 'Made in uvex' quality: First-class products with an in-house value creation chain and a focus on production facilities in Germany/Europe

The easy steps to your VDU spectacles

1 Scheduled appointment and consultation

Make an appointment by phone or email and get advice from uvex experts on the topic of VDU spectacles.

+49 911 97361400

customerservice.sbu-oh@uvex.de

2 Workplace analysis and product search

Our uvex specialists will be happy to present our uvex collection to you in person at your company, and will carry out a workplace analysis with you in order to find the optimal products for you and your employees.

3 Finished VDU spectacles

After consulting and selecting your personal product, either on-site or at one of the uvex optical service partners, the VDU spectacles will be ready for you in a timely manner.

Please contact us for further, non-binding information.



VDU spectacles

Focus types

Posture-related symptoms? The solution – uvex Nahcomfort lenses

Avoid posture-related symptoms with VDU spectacles that are individually adjusted to the wearer. Nahcomfort lenses are specially designed to suit computer-based workplaces and provide unrestricted vision at VDU workstations. The advantages are seamless, sharp vision from 30 cm to approx. 2 m. A clear view of keyboard, screen and documents with an ideal head position. This results in a marked reduction in posture-related symptoms, because the head and neck remain in a natural position.



Nahcomfort



- the wearer's usual reading prescription is found in the lower part of the lens.
- the prescription value gradually becomes weaker further up the lens (degression, in the upper part of the lens, vision is clear at a maximum distance of approx. 2 m). The transitions between the different zones are smooth, similar to varifocal lenses.
- all that is needed to place an order are details of the close-range values and the required design (type A, B, C).
- it is necessary to measure the specific height on the basis of the main line of sight. A minimum fitting height of 17 mm in the frame must be observed.

Type A	Type B	Type C
Degression** 0.75 dpt	Degression** 1.25 dpt	Degression** 1.75 dpt
Addition < 1.5 dpt.	Addition 1.75 to 2.25 dpt.	Addition > 2.25 dpt.
< 50 years	50 to 55 years	> 55 years

VDU spectacles

Finishes

uvex UV blue

- surface finish consisting of different layers. It includes a layer that filters short-wave visible light in the blue-violet range with increased effect.
- effective protection against the symptoms of fatigue and headaches associated predominantly with long periods of working at a monitor and/or with digital media.
- the uvex UV blue layer system also includes a super anti-reflection coating, a scratch-resistant coating and an easy-care layer.



Tint

Tinted lenses provide effective protection against glare in areas with high light intensity (for example, sunlight)

Constant tinting

- available in brown and grey
- tinting levels: 15%, 25%, 65%, 75%

Variable tinting – Variomatic™

- lenses tint automatically, depending on the UV radiation and temperature
- tinting of between approx. 8% and 80% in brown or grey
- available with lens material CR 39

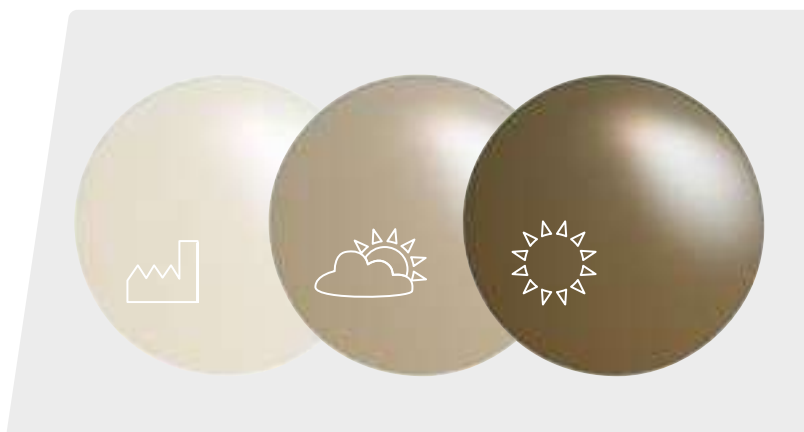

Super anti-reflection incl. easy-care layer

Anti-reflective coating is applied to the inside and outside of lenses by means of vapour deposition. It significantly reduces reflections on the surfaces. It offers a cosmetic advantage and increases light transmission. The easy-care layer makes the glasses easier to clean.

- Maximum reflection reduction
- Metal oxide is applied several times to each surface
- Residual reflection < 2%

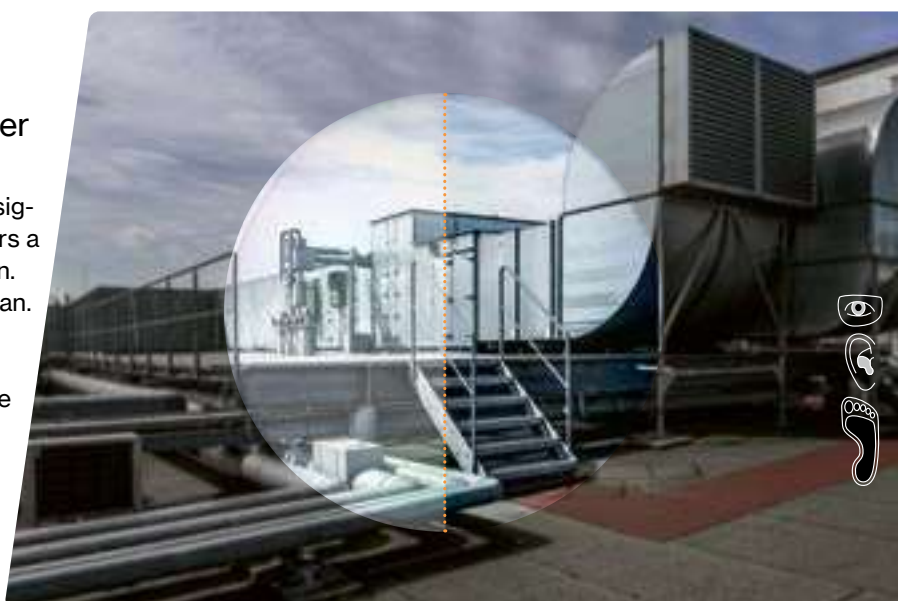

VDU spectacles
Metal frames



6110049



6110052



6110053



6110054



6110055



6110056

	uvex RX 3111	uvex RX 3114	uvex RX 3115	uvex RX 3116	uvex RX 3117	uvex RX 3118
Art. no.	6110049	6110052	6110053	6110054	6110055	6110056
Ref. no.	3111 1172 59/15	3114 1000 52/16	3115 4000 54/16	3116 5500 53/17	3117 1590 48/20	3118 7190 55/17
Lens diameter	59 mm	52 mm	54 mm	53 mm	48 mm	55 mm
Bridge width	15 mm	16 mm	16 mm	17 mm	20 mm	17 mm
Colour	black, khaki	black	bordeaux	brown	grey, vintage	petrol, vintage

VDU spectacles
Metal frames



6110050



6110051



6110019



6110033



6110034



6110018

	uvex RX 3112	uvex RX 3113	uvex RX 3106	uvex RX 3107	uvex RX 3108	uvex RX 3103 Half-moon spectacles
Art. no.	6110050	6110051	6110019	6110033	6110034	6110018
Ref. no.	3112 1233 54/17	3113 1000 53/18	3106 5100 50/20	3107 1000 55/17	3108 1400 54/18	3103 1400 51/20
Lens diameter	54 mm	53 mm	50 mm	55 mm	54 mm	51 mm
Bridge width	17 mm	18 mm	20 mm	17 mm	18 mm	20 mm
Colour	black, blue	black	maroon	black	gun	gun



VDU spectacles

Plastic frames



6110046



6110048



6110037



6110039

	uvex RX 3510	uvex RX 3512	uvex RX 3506	uvex RX 3508
Art. no.	6110046	6110048	6110037	6110039
Ref. no.	3510 1025 52/17	3512 1341 52/18	3506 3329 55/16	3508 1000 54/18
Lens diameter	52 mm	52 mm	55 mm	54 mm
Bridge width	17 mm	18 mm	16 mm	18 mm
Colour	black, translucent	anthracite, red	blue, transparent	black

VDU spectacles
Plastic frames



6110060



6110059



6110061

	uvex RX 3513	uvex RX 3514	uvex RX 3515
Art. no.	6110059	6110060	6110061
Ref. no.	3513 3000 50/20	3514 5441 49/19	3515 5426 55/18
Lens diameter	50 mm	49 mm	55 mm
Bridge width	20 mm	19 mm	18 mm
Colour	dark blue	havanna, red	havanna, matt



VDU spectacles

uvex RX ti · Nylon frames



6110057



6110024



6110058



6110043

	Titanium frames		Metal nylon frames	
	uvex RX ti 3900	uvex RX ti 3901	uvex RX 2104	uvex RX 2105
Art. no.	6110057	6110058	6110024	6110043
Ref. no.	3900 5500 53/16	3901 1400 56/17	2104 1900 54/18	2105 1174 52/17
Lens diameter	53 mm	56 mm	54 mm	52 mm
Bridge width	16 mm	17 mm	18 mm	17 mm
Colour	brown	gun	silver, matt	black, green



uvex high-fit

uvex high-fit hearing protection otoplastics

Customised hearing protection from uvex

**MADE FOR
YOUR EARS**
MADE IN **UVEX**



uvex hearing protection otoplastics are customised to fit the wearer's ear canal and provide the best possible protection in very noisy environments.

uvex high-fit hearing protection otoplastics are tested, certified and permitted for use in very noisy environments in accordance with EN 352. This hearing protection offers maximum wearer comfort over long periods thanks to its highly customised and pressure-free fit.

uvex offers a wide range of otoplastics in various materials and designs that provide different levels of insulation.

All materials used are free of hazardous substances and are tested regularly. The customised otoplastics have a service life of around five years, facilitating a commitment to sustainable retail.

The collection

uvex high-fit otoplastics are customised to the wearer and available in various versions (material/design/filter strength), as well as detectable variants.

uvex flex otoplastics



- flexible otoplastics hearing protection
- made of soft silicone or silicon-free thermo-plastic material
- exceptional wearer comfort thanks to the materials adapting to the user's ear canal
- available in various designs

The classifications are defined as follows:

- S – Signal hearing in railway track superstructure construction
- V – Signal hearing in road traffic
- X – extremely linear attenuation hearing protection. Suitable for people with hearing loss and musicians.
- W – Warning signal hearing, general

uvex duro otoplastics



- sturdy otoplastics hearing protection
- made of silicone-free acrylic material
- comfortable, smooth surface
- available in different designs and as active otoplastics hearing protection

- E – Signal hearing for locomotive drivers in railway operations
- E1 – Exceptionally well suited, particularly suitable for persons with impaired hearing
- E2 – Suitable

Appropriate information can be found in the individual products

uvex otoplastics headsets



- Headset solutions for communication and telephone calls in noisy workplaces
- for connecting to uvex high-fit RS otoplastics hearing protection
- available in different versions (wired or wireless)

Abbreviations:

- HC:** half-concha otoplastics
- FC:** full-concha otoplastics
- u-cut:** U-shape (material removal in the ear canal)
- RS:** real sound
- C-com:** wired headset
- B-com:** wireless headset
- B-com BM:** wireless headset with gooseneck microphone

uvex high-fit hearing protection otoplastics

Customised hearing protection from uvex

uvex as a partner for customised protective equipment

Noise-induced hearing loss is one of the most common occupational illnesses, usually developing slowly and painlessly. Noise does not just affect our hearing – it also has a negative effect on the human body as a whole. With its wide range of hearing protection otoplastics, uvex offers protection with maximum comfort and quality.



Ear moulding: Experts from uvex visit your premises to make moulds of your employees' ears, then uvex uses these moulds to create customised hearing protection.

Function testing: uvex hearing protection otoplastics are subject to a professional function test, which typically must be carried out before the product is first used but at the latest after six months.

We recommend testing the products at least every three years to ensure that the otoplastics offer the required level of protection.

Our service – your benefits

uvex offers maximum service with maximum flexibility.

Our extensive uvex otoplastics collection offers suitable hearing protection otoplastics for every employee.



uvex experts:

- specialists in on-site service
- qualified advisors in uvex customer service
- comprehensive uvex acoustic service partner network throughout Germany



uvex flexibility:

- on-site product consultation and customisation on request
- appointments for early, late or night shifts also available
- optimal planning via the uvex online appointment portal



uvex knowledge:

- decades of experience in acoustics and products under continuous development
- training courses/practical seminars can be provided for your employees (e.g. company doctors, occupational safety specialists)
- 'made in uvex' quality: commitment to a comprehensive quality system with a focus on production facilities in Germany/Europe

Steps to customised hearing protection

1

Appointment and consultation

Make an appointment by email and receive advice from uvex experts on the topic of customised hearing protection.

✉ high-fit@uvex.de

2

Workplace analysis and product identification

Our uvex specialists will be happy to present our uvex collection to you at your premises so you can find the ideal products to protect your employees.

3

Production of otoplastics

Once the ear moulding step has been carried out at your premises or with a uvex acoustic service partner, the otoplastics are promptly delivered and are subject to a final function test, which is typically carried out before the product is first used.



uvex high-fit Industrial otoplastics



6171022



6171050
6171056

Both half- and full-concha designs are available in silicone and acrylic

uvex high-fit flex RS · uvex high-fit duro RS

- otoplastic hearing protection tailor-made to fit the wearer's ear canal
- new linear filter technology in different filter strengths
- optimal linear hearing protection over the entire frequency range
- available in silicone or acrylic
- available in half- or full-concha designs
- compatible with uvex communication headsets

Areas of application:

Workplaces with high communication requirements, musicians, telephony

uvex high-fit flex RS 22	HC	FC	FC detec
Art. no.	6171022	6171052	6171142
SNR	22 dB	22 dB	22 dB
Order unit	PR	PR	PR

uvex high-fit duro RS 20	HC	FC	FC detec
Art. no.	6171020	6171050	6171140
SNR	20 dB	20 dB	20 dB
Order unit	PR	PR	PR

uvex high-fit duro RS 26	HC	FC	FC detec
Art. no.	6171026	6171056	6171146
SNR	26 dB	26 dB	26 dB
Order unit	PR	PR	PR

► We will be happy to change the filter element for you if and when necessary.

uvex otoplastics are made of transparent materials. They are marked left and right with an engraving for ease of fitting and also come with different coloured cord holders.

For an additional fee, we can manufacture your otoplastics in black, white, orange, purple, green, pink



uvex high-fit flex RS otoplastics are also available in red and/or blue upon request, at no extra cost

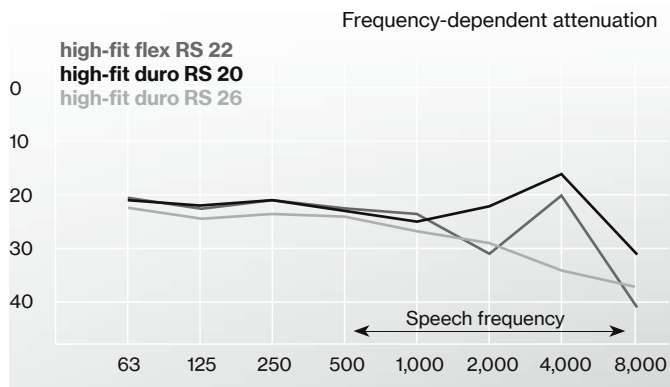

uvex high-fit flex RS 22 (grey filter element)
SNR 22 dB – H 21 dB M 20 dB L 19 dB Classification: W, X, S, E ₁

uvex high-fit duro RS 20 (black filter element)
SNR 20 dB – H 18 dB M 20 dB L 18 dB Classification: W, X, S, V, E ₁

uvex high-fit duro RS 26 (grey filter element)
SNR 26 dB – H 28 dB M 23 dB L 20 dB Classification: W, S, V, E ₂

uvex C-com · uvex B-com otoplastics headsets

uvex C-com · uvex B-com · uvex B-com BM

- specially developed headset with directional microphone
- available as a wired headset with a jack connection and gooseneck microphone, or as a stereo wireless headset with or without gooseneck microphone
- ideal for telephony and communication in very noisy environments
- excellent voice and sound quality in very noisy environments
- volume can be controlled via the integrated remote control
- make hands-free phone calls in the workplace or at the wheel
- practical and secure when worn with uvex high-fit RS otoplastic hearing protection and ear hooks

Areas of application:

Workplaces with high communication requirements, musicians, telephony

	uvex C-com	uvex B-com	uvex B-com BM
Art. no.	6177161	6177162	6177163
Standard	EN 352-2;9	EN 352-2;9	EN 352-2;9
Compatible with	uvex high-fit flex RS, uvex high-fit duro RS		
Order unit	PC	PC	PC

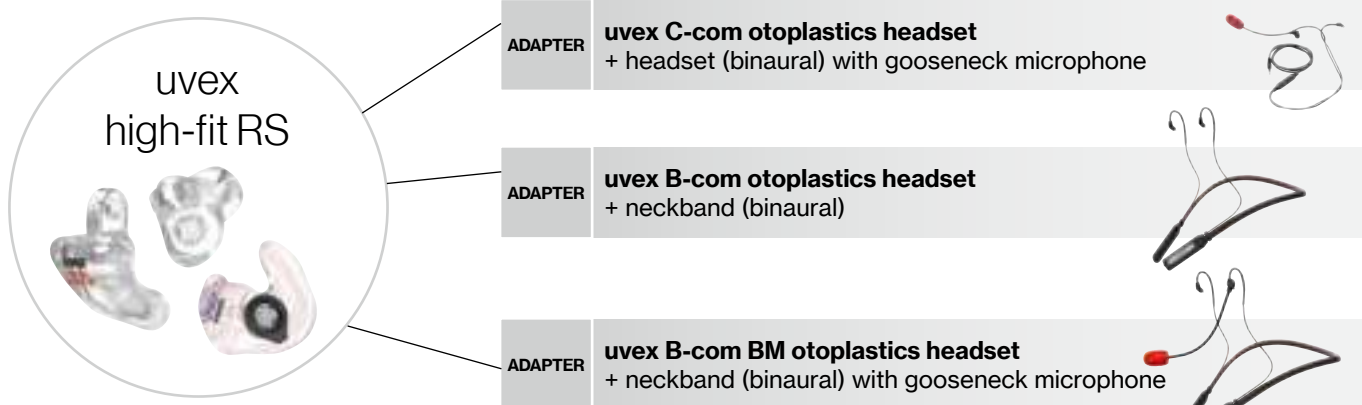
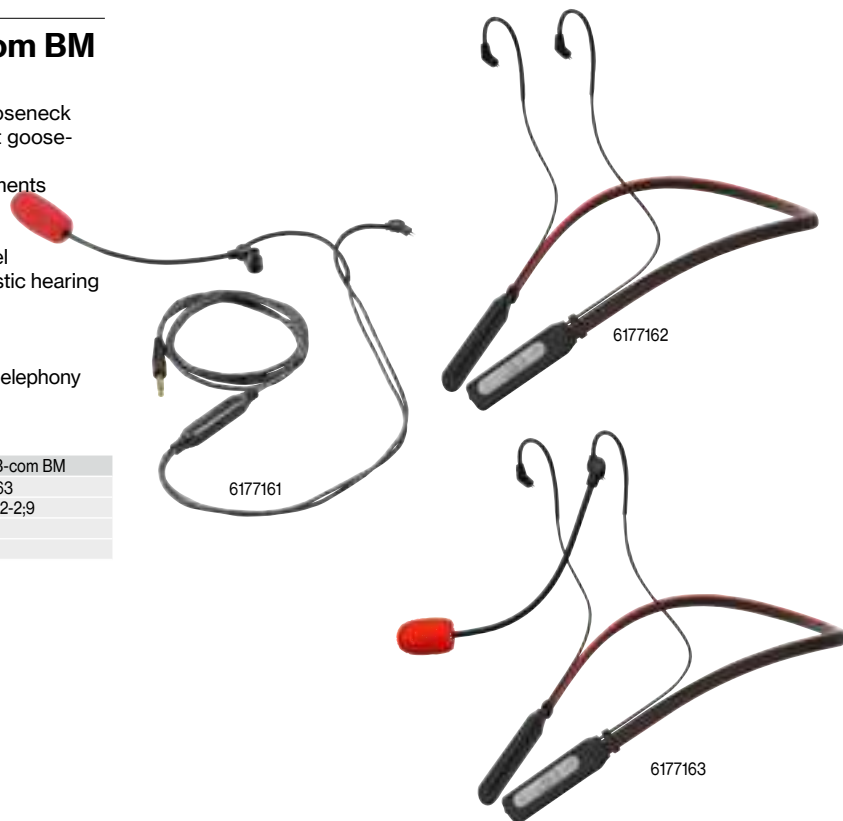

uvex high-fit Industrial otoplastics



uvex high-fit u-cut HC

- half-concha custom otoplastic design
- soft silicone material (dermatologically tested)
- removable otoplastics for the auditory canal offer maximum flexibility; can also compensate for strong jaw movement
- thanks to its unique design, this otoplastic is softer, lighter and more flexible in the auditory canal and on the ear concha for maximum wearer comfort
- with anti-bacterial nano-coating

Areas of application:

- for use in any high-temperature area and by persons with pressure-sensitive ears

uvex high-fit u-cut HC		
Art. no.	6170720	6170726
Standard	EN 352	EN 352
		S, W, E ₂
SNR	20 dB	26 dB
Colour	transparent	transparent

- We will be happy to change the filter element for you if and when necessary.

uvex otoplastics are made of transparent materials. They are marked left and right with an engraving for ease of fitting and also come with different coloured cord holders.

For an additional fee, we can manufacture your otoplastics in black, white, orange, purple, green, pink



uvex high-fit otoplastics are also available in red and/or blue upon request, at no extra cost

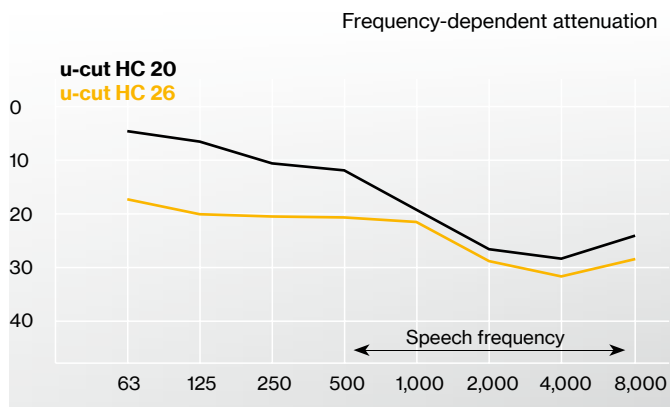

uvex high-fit u-cut HC 20 (black filter element)

SNR 23 dB - H 25 dB M 17 dB L 12 dB

uvex high-fit u-cut HC 26 (yellow filter element)

SNR 26 dB - H 25 dB M 23 dB L 21 dB

Classification: S, W, -, E₂

uvex high-fit Industrial otoplastics



uvex high-fit u-cut FC

- full-concha custom otoplastic design
- soft silicone material (dermatologically tested)
- removable otoplastics for the auditory canal offer maximum flexibility; can also compensate for strong jaw movement
- thanks to its unique design, this otoplastic is softer, lighter and more flexible in the auditory canal and on the ear conch for maximum wearer comfort
- with anti-bacterial nano-coating

Areas of application:

- for use in any high-temperature area and by persons with pressure-sensitive ears

uvex high-fit u-cut FC		
Art. no.	6170703	6170704
Standard	EN 352	EN 352
		S, W, E ₂
SNR	20 dB	26 dB
Colour	transparent	transparent

► We will be happy to change the filter element for you if and when necessary.

uvex otoplastics are made of transparent materials. They are marked left and right with an engraving for ease of fitting and also come with different coloured cord holders.

For an additional fee, we can manufacture your otoplastics in black, white, orange, purple, green, pink



uvex high-fit otoplastics are also available in red and/or blue upon request, at no extra cost



Frequency-dependent attenuation

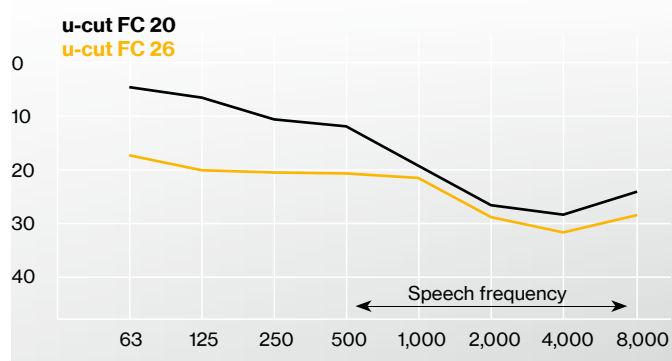

uvex high-fit u-cut FC 20 (black filter element)

SNR 20 dB - H 25 dB M 17 dB L 12 dB

uvex high-fit u-cut FC 26 (yellow filter element)

SNR 26 dB - H 28 dB M 23 dB L 21 dB

Classification: S, W, -, E₂



uvex high-fit
Industrial otoplastics



6170023
6170026
6170028

uvex high-fit flex · uvex high-fit flex detec

- otoplastic hearing protection individually adjusted to the ear canal
- best possible protection due to the perfect fit and a high level of wearer acceptance
- available in different filter strengths
- high level of wearer comfort with soft silicone material
- easy handling with comfortable grip
- antibacterial nano-coating
- detectable variants with a metal ball bearing and a detectable blue cord to ensure they can be found by metal detectors.

uvex high-fit flex			
Art. no.	6170023	6170026	6170028
Standard	EN 352-2	EN 352-2	EN 352-2
		S, W, E ₂	S, W, E ₁
SNR	23 dB	26 dB	28 dB
Colour	transparent	transparent	transparent

uvex high-fit flex detec			
Art. no.	6170423	6170426	6170428
Standard	EN 352-2	EN 352-2	EN 352-2
		S, W	S, W
SNR	23 dB	26 dB	28 dB
Colour	transparent	transparent	transparent
Special feature	detectable	detectable	detectable

► We will be happy to change the filter element for you if and when necessary.

uvex otoplastics are made of transparent materials. They are marked left and right with an engraving for ease of fitting and also come with different coloured cord holders.

For an additional fee, we can manufacture your otoplastics in black, white, orange, purple, green, pink



uvex high-fit otoplastics are also available in red and/or blue upon request, at no extra cost

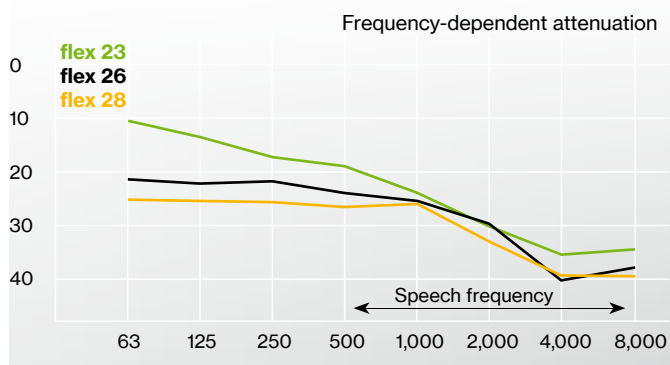

uvex high-fit flex 23 (green filter element)
SNR 23 dB - H 27 dB M 19 dB L 15 dB

uvex high-fit flex 26 (black filter element)
SNR 26 dB - H 28 dB M 23 dB L 20 dB
Classification: S, W, ---, E ₂

uvex high-fit flex 28 (yellow filter element)
SNR 28 dB - H 29 dB M 24 dB L 22 dB
Classification: S, W, ---, E ₁

uvex high-fit Industrial otoplastics



uvex high-fit temp flex

- otoplastic hearing protection individually adjusted to the ear canal
- fully silicone-free
- best possible protection due to the perfect fit and a high level of wearer acceptance
- available in different filter strengths
- easy handling with comfortable grip
- adapts perfectly to the anatomy of the wearer: on insertion, the otoplastic is dimensionally stable; the material gets softer after a few minutes due to the temperature in the ear canal

Areas of application:

- ideally suitable for the paint-processing industry

uvex high-fit temp flex		
Art. no.	6170524	6170528
Standard	EN 352-2	EN 352-2
SNR	24 dB	28 dB
Colour	transparent	transparent

- We will be happy to change the filter element for you if and when necessary.

uvex otoplastics are made of transparent materials. They are marked left and right with an engraving for ease of fitting and also come with different coloured cord holders.

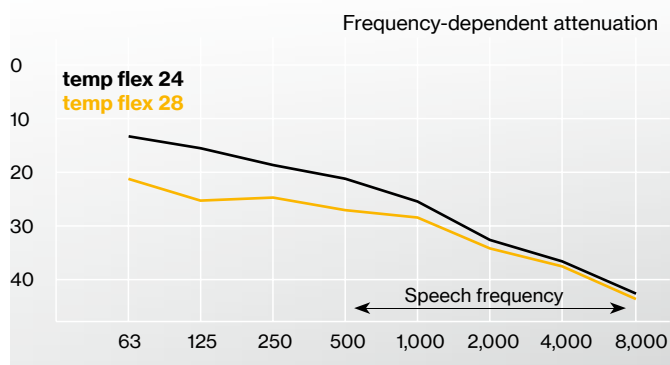

uvex high-fit temp flex 24 (black filter element)
SNR 24 dB - H 28 dB M 21 dB L 16 dB

uvex high-fit temp flex 28 (yellow filterelement)
SNR 28 dB - H 30 dB M 24 dB L 21 dB
Classification: S, W, ---, E₂



uvex high-fit Industrial otoplastics



6170824
6170828
6170832

uvex high-fit duro · uvex high-fit duro detec

- otoplastic hearing protection individually adjusted to the ear canal made from dimensionally stable duroplast material
- fully silicone-free
- detectable variants with a metal ball bearing and a detectable blue cord to ensure they can be identified by metal detectors.
- best possible protection with perfect fit and high level of wearer acceptance
- available in different filter strengths
- smooth, even surface
- easy handling with comfortable grip
- antibacterial nano-coating

Areas of application:

- ideally suitable for the paint-processing industry and for areas with very fine dust
- uvex high-fit flex detec ideally suited for sectors in the food industry

uvex high-fit duro			
Art. no.	6170824	6170828	6170832
Standard	EN 352-2	EN 352-2	EN 352-2
SNR	24 dB	28 dB	32 dB
Colour	transparent	transparent	transparent

uvex high-fit duro detec			
Art. no.	6170424	6170418	6170432
Standard	EN 352-2	EN 352-2	EN 352-2
SNR	24 dB	28 dB	32 dB
Colour	transparent	transparent	transparent
Special feature	detectable	detectable	detectable

uvex otoplastics are made of transparent materials. They are marked left and right with an engraving for ease of fitting and also come with different coloured cord holders.

uvex high-fit otoplastics are also available in red and/or blue upon request, at no extra cost



Frequency-dependent attenuation

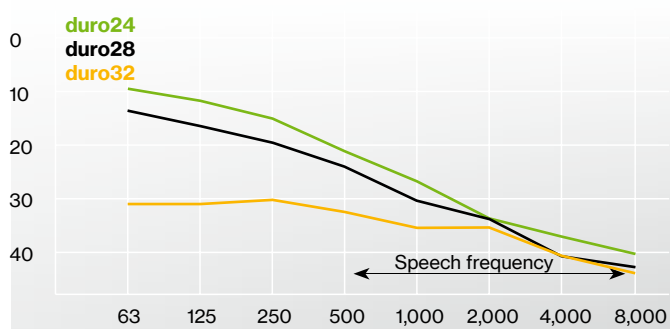

uvex high-fit duro 24 (green filter element)

SNR 24 dB – H 30 dB M 21 dB L 15 dB

uvex high-fit duro 28 (black filter element)

SNR 28 dB – H 32 dB M 24 dB L 18 dB

uvex high-fit duro 32 (yellow filter element)

SNR 32 dB – H 33 dB M 29 dB L 27 dB

Classification: S, W, V, E₁

uvex high-fit
Industrial otoplastics



6170840

uvex high-fit duro active

- active otoplastic hearing protection – tailor-made to the individual's ear canal
- finely tuned and highly sensitive microphones
- best directional and ambient acoustics
- very high level of passive insulation
- outstanding high-tech amplifier technology for impulse noise
- protection in the event of a shot or bang (up to 164 dB)
- electronic limitation closes in less than 10 milliseconds
- cerumen filter system protects against moisture and sweat
- assists the wearer in situations where hearing and communication may be difficult, such as when communicating in very noisy workplaces or where early detection of quiet sounds is required

Areas of application:

Workplaces with high communication requirements, very loud environments, employees with hearing loss or those affected by impulse sounds

Frequency-dependent attenuation

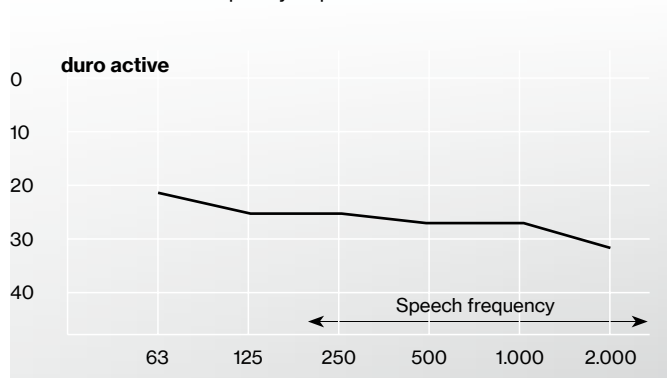

uvex high-fit duro active	
Art. no.	6170840
Norm	EN 352-2, EN 352-7
Standard	26 dB
Colour	black, beige

uvex high-fit duro active (black filter element)	
SNR	26 dB – H 28 dB M 22 dB L 20 dB



6177157

6177158

Included

- active otoplastic hearing protection – tailor-made to the individual's ear canal
- hard shell case
- 1 blister pack of zinc-air batteries, size 312
- 1 blister pack of earwax filters
- uvex cleaning cloths for otoplastics
- User information

Replacement batteries	
Art. no.	6177157
Type	1 PC blister pack of 6 zinc-air batteries, type 312
Order quantity multiples	10 PC

Replacement cerumen filters	
Art. no.	6177158
Type	1 PC blister pack of 8 filters
Order quantity multiples	5 PC



uvex high-fit
Special model



6170315
6170320
6170326

uvex high-fit u-cut com4

- otoplastic hearing protection customised to the wearer's auditory canal
- soft silicone material (dermatologically tested)
- removable otoplastics for the auditory canal offer maximum flexibility
- ideal for leisure activities thanks to small auditory canal design without grip
- with anti-bacterial nano-coating

Areas of application:

- sleeping, flying, shared office spaces, phone calls, concerts, work areas without designated noise areas

Please note that our u-cut com4 model with an SNR of 15 dB is not suitable or certified for use in designated noise areas.

uvex high-fit u-cut com4			
Art. no.	6170315	6170320	6170326
Standard	EN 352	EN 352	EN 352
SNR	15 dB	20 dB	S, W, -, E ₂ 26 dB
Colour	transparent	transparent	transparent

uvex otoplastics are made of transparent materials. They are marked left and right with an engraving for ease of fitting and also come with different coloured cord holders.

For an additional fee, we can manufacture your otoplastics in black, white, orange, purple, green, pink



uvex high-fit otoplastics are also available in red and/or blue upon request, at no extra cost

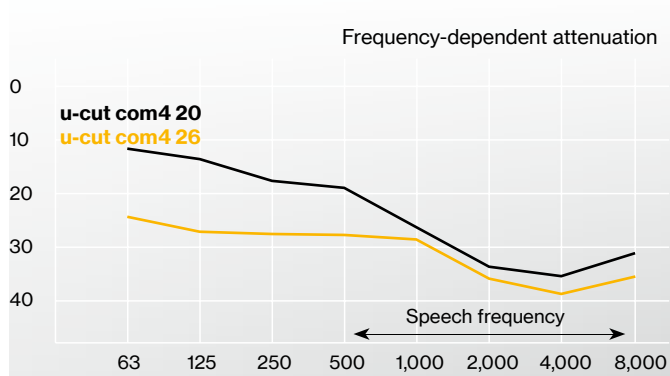

uvex high-fit u-cut com4 20 (black filter element)
SNR 20 dB – H 25 dB M 17 dB L 12 dB

uvex high-fit u-cut com4 26 (yellow filter element)
SNR 26 dB – H 28 dB M 23 dB L 21 dB
Classification: S, W, -, E₂

uvex OTOCheck

Instructions for checking the function of your equipment online

uvex OTOCheck allows you to check the function of your uvex otoplastic hearing protection online in a quick and easy process. After completing the straightforward registration process, you will be able to access an overview of your otoplastics orders and view the status of your function tests using the simple traffic light system.

Function testing:

uvex hearing protection otoplastics are subject to a professional function test, which typically must be carried out before the product is first used but at the latest after six months. We recommend testing the products at least every three years to ensure that the otoplastics offer the required level of protection.



Your benefits at a glance:

- ✓ Check the function of your equipment using a straightforward, digital process
- ✓ Simple registration
- ✓ Create multiple user profiles on one account
- ✓ Clear data management for your otoplastics orders
- ✓ Check the status of function tests that have already been completed
- ✓ Documentation of all test reports for quality assurance purposes



What you need for uvex OTOCheck:

- ✓ A computer, tablet or laptop
- ✓ An Internet connection
- ✓ Headphones

We recommend headphones that are suitable for uvex OTOCheck (article number 6178121). Please get in touch with us and we will be happy to advise you.



uvex high-fit Special features



Included

uvex high-fit otoplastics are supplied in a zipped case, including textile cord, cleaning rod, cleaning cloths and user information.

Silicone otoplastics are delivered with a tube of audinell gel.

uvex click case

- small click case for otoplastics

uvex click case	
Art. no.	6177115
Order quantity multiples	10 PC

uvex clear otoplastics

- silicone-free towelettes for quick and easy cleaning of hearing protection otoplastic, suitable for all otoplastic materials
- packaging: 30 per box

uvex clear otoplastics	
Art. no.	6177116
Order unit	PC
Contents	30 towlettes per PC

uvex high-fit band

- neck handle for hearing protection otoplastics in zip-up case
 - easy to attach the otoplastic to the band using colour-coded connector sleeves
 - no disruptive transmission noise because the band prevents the cord rubbing on clothing
 - band significantly relieves strain
 - comfortable to wear around the neck during breaks
- Areas of application:
- ideal for activities with frequent and/or fast head movements

Band	
Art. no.	6177112
Order unit	PC

uvex high-fit replacement kits

- | | |
|---------------------------------|---------------------------------|
| Detectable replacement kit for: | Detectable replacement kit for: |
| • uvex high-fit flex detec | • uvex high-fit flex com detec |
| • uvex high-fit duro detec | |

Fabric cord replacement kit	
Art. no.	6177156
Design	comprising 900 mm textile cord and a pair of fastening sleeves (red/blue)
Order quantity multiples	10 PC

Detectable replacement kit	
Art. no.	6177111
Design	consists of an elastic cord 800 mm (blue, detectable) and a pair of connector sleeves (blue, detectable)
Order quantity multiples	10 PC

Detectable replacement kit	
Art. no.	6177211
Design	consists of an elastic cord 800 mm (blue, detectable) and a pair of connector sleeves each (blue, detectable), sealing plugs (red/blue) and disposable plugs
Order quantity multiples	10 PC



uvex medicare

uvex medicare

Orthopaedic solutions for uvex safety shoes

**MADE FOR
YOUR FEET**
MADE IN UVEX



The customised solutions provided by uvex medicare solve foot-related medical problems in the workplace and offer individual, expertly designed orthopaedic solutions.

uvex medicare supplies orthopaedic insoles as well as orthopaedic shoe adjustments for uvex safety shoes.

The orthopaedic uvex medicare solutions are tested with uvex safety shoes and certified in accordance with DIN EN ISO 20345.

German Social Accident Insurance (DGUV) regulation 112-191 stipulates that a fully certified orthopaedic solution must be used at working places. Wearing privately purchased orthopaedic insoles in safety shoes is therefore not permitted.

All of the materials uvex uses are free of hazardous substances and are tested regularly.

The collection

uvex motion 3XL



Amazingly spacious:

- significantly larger inside than other comparable safety shoes
- considerably wider than size 15
- exceptionally high, anatomically shaped toe cap
- pressure points eliminated

uvex orthopaedic comfortable customised inserts/ uvex orthopaedic adjustments



All uvex safety shoes that are marked with the uvex medicare symbol can be fitted with uvex orthopaedic comfortable customised inserts or an orthopaedic adjustment.



The uvex medicare + logo indicates that both orthopaedic customised inserts and orthopaedic adjustments are available.

uvex as a partner for customised protective equipment

Scientific studies prove that well over half the adult population suffers from orthopaedic problems such as flat feet, skewfoot, splayfoot or fallen arches. These conditions have an undisputed effect on the entire musculoskeletal system and physical performance.

With our orthopaedic uvex medicare solutions for uvex safety shoes and the uvex motion 3XL, we offer various orthopaedic protection solutions that are tailored to each individual employee. Maximum comfort and quality guaranteed.

Our service – your benefits

uvex offers maximum service with maximum flexibility. Our experts are happy to advise you on professional and flexible solutions, tailored to the individual requirements of your company.



uvex experts:

- specialists in on-site service
- qualified advisors in uvex customer service
- comprehensive uvex orthopaedics service partner network throughout Germany



uvex flexibility:

- on-site product consultation and customisation on request
- appointments for early, late or night shifts also available
- optimal planning via the uvex online appointment portal



uvex knowledge:

- decades of experience in orthopaedics and products under continuous development
- training courses/practical seminars can be provided for your employees (e.g. company doctors, occupational safety specialists)
- 'made in uvex' quality: commitment to a comprehensive quality system with a focus on production facilities in Germany/Europe

Steps to orthopaedic solutions for uvex safety shoes

1 Appointment and consultation

Make an appointment by email and receive advice from uvex experts.

✉ medicare@uvex.de

2 Workplace analysis and product identification

Our uvex experts will be happy to introduce you to our uvex medicare programme at your premises. Each orthopaedic medicare solution is designed using a medical diagnosis and a blueprint of the foot.

Together, we can find the ideal products for you so you can protect your employees.

3 Complete orthopaedic solution

Delivery is quick and easy.

Contact us for more information with no obligation.



uvex medicare

uvex motion 3XL

More than just a standard solution

It is quite common for people who have pre-existing foot conditions to struggle with safety footwear, and often their only option is to turn to expensive custom-made solutions. Industrial health and safety experts at uvex have developed the uvex motion 3XL that combines the features of standard safety footwear with custom-made orthopaedic shoes. uvex motion 3XL perfectly combines all the requirements for safety and wearer comfort, making it the professional and practical solution.

uvex motion 3XL: more than just safety footwear

uvex motion 3XL has been specially designed to be highly versatile when used in conjunction with orthopaedic insoles and shoe adjustments. The volume of uvex motion 3XL has ample room for inserting a thick insole, for example, a special diabetic insole.

Where the **uvex** **motion 3XL** can help



Diabetes



Foot misalignment or deformations



Ankle inflammation and osteoarthritis



Joint blockages, tendon contractures, heel spur



Lower leg problems



64963



uvex motion 3XL · Shoe S3 SRC

General features:

- extremely wide innovative shoe
- virtually seam-free construction
- pressure points virtually eliminated
- mostly metal-free
- largely free from silicone and plasticiser
- one of the lightest therapeutic safety shoes of its class
- helps to reduce downtime due to ill-health
- offers enough room for diabetes-adapted foot bedding

Protection characteristics:

- meets ESD specifications with bleeder resistor under 35 megaohms
- non-slip outsole and non-metallic penetration-resistant insert – despite high flexibility of the shoe
- 100 % metal-free uvex medi-cap toe cap – compact, anatomically formed, not thermally conductive and with good side stability
- secure standing even on ladders due to optimal profile design with self-cleaning studs and additional stable arch

Comfort features:

- perfect foot climate at all times thanks to breathable lining and outer shoe material
- ergonomic lightweight construction and above-average shock absorption increases wearer comfort and prevents fatigue
- comfortable and virtually pressure-free
- cushioned shaft edge, three-layered padded lining
- customisable complete orthopaedic package
- uvex medicare certified up to 3 cm raised sole
- additional movement space in toe area 1 cm

Areas of application:

- medium area of application, in sectors such as chemical industry, transport and logistics, energy, machine construction and metal processing
- also suitable for therapeutic purposes, e.g. diabetic care

uvex motion 3 XL	Shoe S3 SRC
Art. no.	64963
Width	> 15
Standard	EN ISO 20345: 2011 S3 SRC
Upper material	breathable, water-resistant
	high-tech microvelour
Size	35 to 50



uvex medicare

uvex motion 3XL safety footwear – functionality in every detail



Size comparison

Exceptionally high, anatomically shaped toe cap

The extremely high and wide uvex **medi-cap** ensures sufficient room for deformed feet (e.g. hammer, claw and mallet toes), a splint, an inner shell or a light foot bandage, so the risk of pressure points is reduced. In addition, this model offers good freedom of movement around the toes taking into account the big toe joint.

Secure and adjustable lacing system

Extremely soft, padded tongue with external individually adjustable lacing system.



Soft, elasticated transition

The transition from toe cap to tongue protects the metatarsophalangeal (MTP) joints at the base of the toes.

Increased space

Additional space for movement to reduce pressure points.



All-round cap for impact protection

All-round shoe casing increases protection for wearer and the product life of the shoes.

Metal-free toe cap and midsole

Penetration-resistant sole and toe cap of high-tech plastics fulfil requirements of S3 shoes in accordance with norm EN ISO 20345:2011.

Generous foot width

Considerably wider than size 15. Ample room for inserting a thick insole, e.g. special diabetic insole.

66%
more volume



uvex motion 3XL

A true "space miracle"

Minimal seams
To prevent potential rubbing points, the shoes have only three seams which align with the movement direction of the foot. A further feature that reduces pressure points.

Extended heel cap
The heel cap is extended both inside and outside which ensures optimum heel guidance. This improves body static and increases stability.



Padded shoe shaft
Special padding in the collar, ankle and achilles tendon area prevent pressure points.

Maximum comfort
Triple-layer lining with ultra-soft padding.

Complete orthopaedic package
Construction material comprising soft, conductive EVA 6 mm thick foam, in combination with orthopaedic inserts with EVA core.

20%
more width



uvex medicare

Comfortable customised inserts – Insert technology for tailor-made treatment

EVA soft-foam technology



uvex 3D hydroflex® foam

- optimum moisture absorption and release
- excellent shock absorption in high-strain zones such as the ball and heel of the foot
- smooth surface
- excellent abrasion resistance

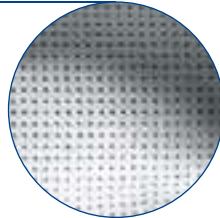

ORTHOPAEDIC ADJUSTMENT

- modular concept
- adapts to assist natural movement

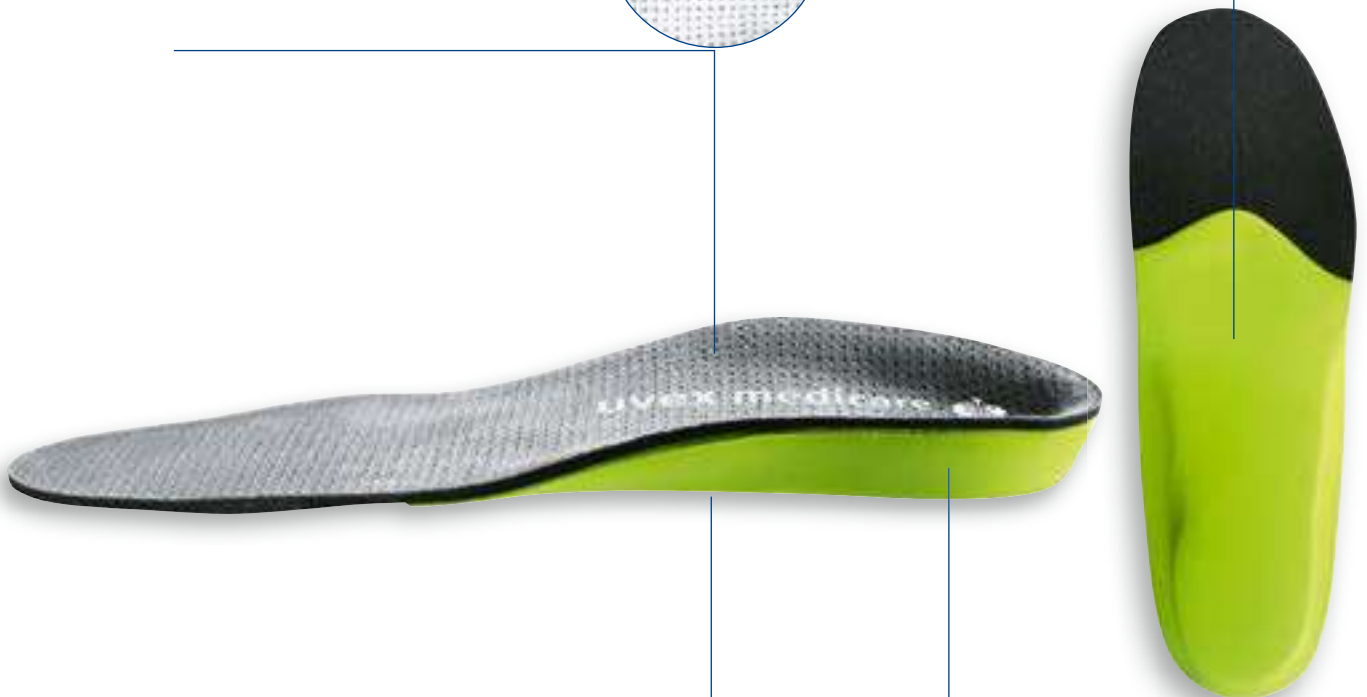

VARIOUS MEDICAL CONCEPTS

Applicable – depending on classification:

- conventional orthopaedics
- sensorimotor function
- Spiraldynamik®
- supports correct bio-mechanical foot rolling
- does not require to be 'broken in'
- high wearer comfort

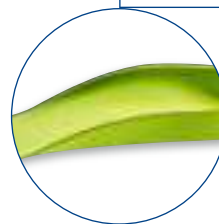
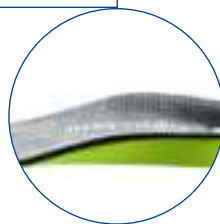

SUPPORTING CORE

- 2 levels of shore hardness (medium/soft) selected according to requirements: Individually adaptable to body type and support requirements
- high support, guiding and shock absorption properties through soft, raised heel shell

Orthopaedic uvex comfort custom insole
Art. no. 6499902

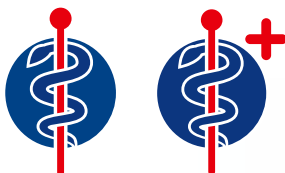

All products suitable for orthopaedic foot protection are indicated in this catalogue with the uvex medicare symbol.

uvex medicare logo
Certified for orthopaedic inserts
uvex medicare + logo
Certified for orthopaedic inserts and shoe adjustments

Our orthopaedic uvex customised comfort inserts and orthopaedic shoe adjustments are only certified in accordance with specific safety shoes in each case.

To avoid safety risks, it is essential that you select the right safety shoe for the product (notes in main catalogue). We accept no liability for non-certified combinations. Please do not hesitate to contact us should you have any concerns regarding the right safety shoe.

Our orthopaedic uvex comfortable customised inserts and orthopaedic shoe adjustments are certified in accordance with EN ISO 20345:2011 in combination with uvex safety shoes, which are marked in the uvex catalogue with the uvex medicare symbol.

Orthopaedic shoe adjustments



6499911

Shoe lift

A shoe lift is required to balance legs of different length.

A shoe lift should never exceed 3 cm.



6499913

Roller sole

A roller sole eases the burden on the feet during your stride. The precise effect is governed by the location of the pressure point. This helps adjust the length of your stride.

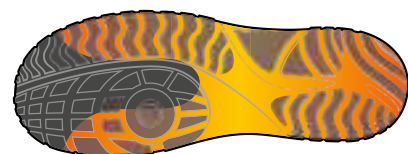

6499914

Butterfly roller

A butterfly roller reduces the burden on sensitive metatarsal bones by dissipating the pressure caused by each stride. By moving the pressure point, you can create an extra rocking effect.

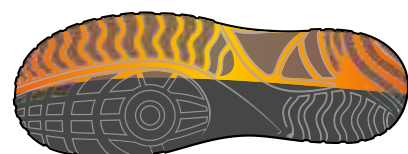
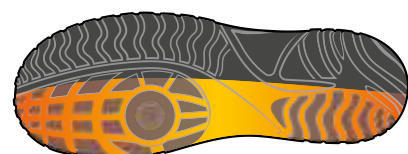

6499915

Outer and inner sole wedges

By using a wedge, you can adjust the slope beneath the feet in a standing position and correct the line of your stride when walking.

Orthopaedic shoe adjustments	
Art. no.	6499911
Design	orthopaedic shoe lift
	up to 1 cm per side

Art. no.	6499912
Design	shoe lift per additional cm
	(up to max. 3 cm) per side

Art. no.	6499913
Design	roller sole

Art. no.	6499914
Design	butterfly roller

Art. no.	6499915
Design	external or internal edge lift

Art. no.	6499907
Design	sole stiffener (only as addition in connection with a shoe adjustment initial position)

The declarations of conformity are available to download at: www.uvex-safety.de/ce-medicare

Note: For shoe adjustments, the temperature resistance of the sole is reduced to 60 °C.

Note: For Austria, the uvex naturform range is not approved in accordance with ÖNORM Z1259. Only "variant A – orthopaedic insert" for model 69608 uvex xenova® hygiene sling is possible in accordance with ÖNORM Z1259.





Prescription spectacles and workplace safety

The common key features of prescription safety spectacles are that they compensate the wearer's defective vision and protect the eyes from mechanical and optical influences. This seminar will enable participants to act as a competent representative within the company for prescription safety spectacles right through to fitting.

- Information regarding legal regulations, test specifications and standards
- Sharing knowledge about prescription safety spectacles
- Explanation of the different types of lens and frame materials available, their specific features and properties
- Explanation of the various focus types and their best use

- Assessment of the risks in the respective workplace and selection of the most appropriate prescription safety spectacles
- Ability to determine the necessary parameters for fitting prescription spectacles
- Practical demonstration of selection, consultation, and fitting of prescription safety glasses
- Instruction regarding the best care and handling of prescription safety spectacles

Target group

Those responsible for the work-related health and safety of employees within a company and/or those who are to fit prescription safety spectacles, such as safety officers, company doctors and their support staff.



For further information and to register visit uvex-academy.com, phone +49 911 9736-1710 or e-mail academy@uvex.de



Workwear
Protective clothing



protecting planet

To raise awareness of its commitment to achieving increased sustainability, uvex has developed the **protecting planet** icon.

For uvex, **protecting planet** is more than a label. Based on the brand claim, **protecting people**, our sustainable approach integrates three interlinked core pillars – **ecology**, **economy** and **social responsibility**, that are incorporated throughout the business to improve our sustainability performance.

This explains the comprehensive audit, and evaluation management process uvex undertakes along the entire value chain to ensure its products are as sustainable as possible.



uvex suXXeed greencycle planet

The **uvex suXXeed greencycle planet** collection is an example of the **planet series** product system



protecting planet

by reducing waste //
by using compostable material //
by maximum reduction of pollutants

All material components of the clothing are completely compostable and all products carry the cradle to cradle™ certification. In addition to cotton, the real stand out feature here is the use of a special polyester and elastane, which decompose within a very short time due to the co-polymer structure. The cradle to cradle™ clothing uses only substances that have been proven to not affect human health. Furthermore, the cradle to cradle™ Gold certificate ensures that no process chemicals enter waste water. When the clothing has been worn, the components of the clothing can be fed back into circulation by composting.



protecting planet

by using environmentally-friendly packaging

The individual packaging, including all hang tags and labels, are also biodegradable.



protecting planet

by saving energy

Renewable energy is used to produce the clothing. At the same time, at least 50 percent of direct on-site emissions are compensated for. Production in Europe and the associated short transport routes ensure that there are no unnecessary environmental impacts.



uvex

uvex suXXeed greencycle planet

Sustainable workwear through and through

With the uvex suXXeed greencycle planet collection, we have succeeded in creating the very first biodegradable workwear. Suitable for both men and women working in warehouses, offices or for recreation, the collection offers a timeless look and even has Cradle to Cradle™ certification.

FINALIST



German
Sustainability Award
Design 2023



Worker shirt

Art. no. **88812** ■ anthracite

Size S to 6XL

Material 48% cotton, 48% polyester, 4% elastane, approx. 230 g/m²



Description: • biodegradable polyester and elastane • regular fit • button panel in the front centre • turndown collar • one breast pocket with glasses and pen loop • cuffs with button fastening • Cradle to Cradle™ gold certified

Bermuda

Art. no. **88811** ■ anthracite

Size 42 to 64

Material 48% cotton, 48% polyester, 4% elastane, approx. 230 g/m²



Description: • biodegradable polyester and elastane • regular fit • ergonomic cut • crotch insert • elasticated waistband at rear, buttoned fly • left side pocket with button fastening • folding rule pocket, as well as pen pocket on the right • back pockets • uvex logo engraved • Cradle to Cradle™ gold certified



Cargo trousers

men

Art. no. **88868** ■ anthracite

Size 42 to 64, 90 to 110

women

Art. no. **88876** ■ anthracite

Size 34 to 54

Material 48% cotton, 48% polyester, 4% elastane, approx. 230 g/m²



Description: • biodegradable polyester and elastane • regular fit • ergonomic cut • crotch insert • elasticated waistband at rear, buttoned fly • left side pocket with button fastening • folding rule pocket, as well as pen pocket on the right • back pockets • uvex logo engraved • Cradle to Cradle™ gold certified



T-shirt

men

Art. no. **88888** ■ moss green

■ light grey

■ light blue

Sizes S to 6XL

women

Art. no. **88885** ■ moss green

■ light grey

■ light blue

Sizes XS to 4XL

Material 98% cotton, 2% elastane, approx. 170 g/m²



Description: • biodegradable elastane • regular fit (men and women) • round neck (men) • submarine neckline (women) • Cradle to Cradle™ gold certified



Polo shirt

men

Art. no. **88360** ■ black
88361 □ white

Size S to 4XL

Material 70% cotton, 30% polyester pique, approx. 200 g/m²



Description: • casual polo shirt in a comfortable material mix • clean loose fit • OEKO-TEX® Standard 100



Whether indoors or outdoors – with uvex 24/7/365 for work, sports & leisure

uvex has been protecting people since 1926 — at work, in sport and for leisure. Collection 26's trendy colours and special materials effectively blend recreational design elements with quality work clothing features.

In any weather.
Durable. Urban.
At work and at play.



Rain jacket

men

Art. no. **88354** ■ saffron

Size S to 4XL

women

Art. no. **88355** ■ saffron

Size XS to 3XL

Material 100% polyester (recycled), approx. 110 g/m²



Description: • light and functional with small pack size • waterproof zip and hood for rainy days in the city • "high-rise" arm design • tailored (women) • breathability MVP 8,000 g/m²/24 h • 10,000 mm water column



Parka

men

Art. no. **88352** ■ dark blue

88323 ■ olive

Size S to 4XL

women

Art. no. **88353** ■ dark blue

Size XS to 3XL

Material outer fabric: 100% nylon, lining and padding: 100% polyester, approx. 170 g/m²



Description: • warming, wind-resistant and water-resistant • clean urban look • padding for optimal heat insulation • preformed tailored fit (women) for maximum freedom of movement • pockets with zip • breathability MVP 10,000 g/m²/24 h • 10,000 mm water column



Functional trousers

men

Art. no. **88350** ■ black

Size 42 to 64, 90 to 110

women

Art. no. **88351** ■ black

Size 34 to 50

Material 92% polyamide, 8% elastane, approx. 178 g/m²



Description: • stylish and ultra-light • abrasion-resistant on the outside • soft brushed on the inside • chino shape with intelligent 3D pattern design • pockets with zip



uvex suXXeed family

One design, one fit, one range.

From head to toe, from underwear to arc protection, from recreation to protective clothing: The uvex suXXeed family's comprehensive range guarantees something for everyone. Whether you are looking for professional and protective clothing suitable for leasing or a sustainable leisure style, the uvex suXXeed collections are as extensive and flexible as the tasks for which they were created.

Flexibility and comfort are guaranteed thanks to different fit shapes and perfectly matched materials. The cuts and the 360° performance fit ensure a perfect fit and, thanks to the different models for men and women, anyone can get a feel for the extraordinary workwear up close.

Want some variety? Thanks to the selected colours and materials, all products in the collection are perfectly adapted to the most diverse requirements of workplaces. However, with well-matched items in the line, there is nothing to stop you mixing and matching and piecing together favourites yourself. Ensuring safety meets style.



uvex suXXeed



uvex suXXeed basic



uvex suXXeed craft



uvex suXXeed greencycle planet



uvex suXXeed graphit

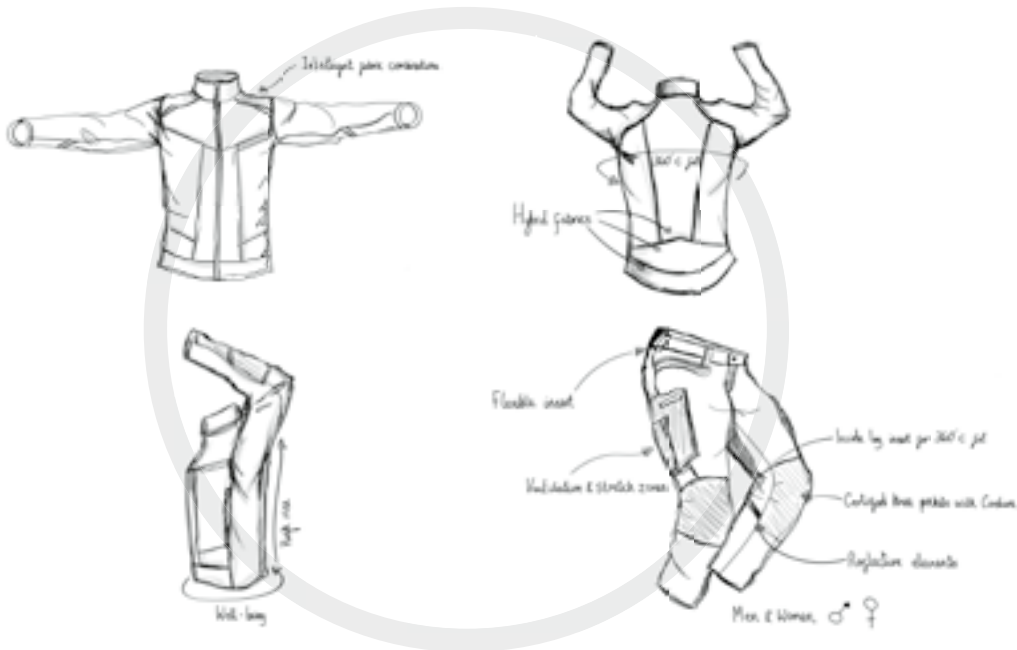

uvex suXXeed seamless underwear

uvex suXXeed industry

uvex suXXeed construction

uvex suXXeed arc

uvex suXXeed ESD

uvex suXXeed multifunction



uvex suXXeed

The classic for any wearer. Women too.

Crafts and industry, regular and slim fit, women's and men's clothing – these don't have to be opposites. The uvex suXXeed collection combines the best of different worlds with its 360°-fit and casual design. Unusual material combinations and an excellent fit offer a solution for those who do not want to compromise when it comes to their work clothes.

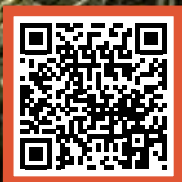

Video



Cargo trousers

men – regular fit

Art. no. **89668** ■ midnight blue
89669 ■ graphite
 Size 23 to 32, 42 to 66, 90 to 110

women – regular fit

Art. no. **89686** ■ midnight blue
89688 ■ graphite
 Size 19 to 26, 34 to 54
 Material 65% polyester, 35% cotton, approx. 245 g/m²



Description: • flexible waistband • ventilation zones with stretch insert at the back of thighs • two back and thigh pockets each reinforced with CORDURA® • integrated folding rule, mobile phone and tool pocket • knee reinforcement made of CORDURA® (men and women) and knee pockets inside (men) for knee pads (art. 9868900) • reflex details • OEKO-TEX® Standard 100



Cargo trousers

men – slim fit

Art. no. **89659** ■ midnight blue
89665 ■ graphite
 Size 23 to 32, 42 to 66, 90 to 110

women – slim fit

Art. no. **88288** ■ midnight blue
88287 ■ graphite
 Size 19 to 26, 34 to 54
 Material 60% cotton, 20% polyester, 20% elastane, approx. 280 g/m²

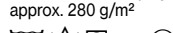

Description: • casual slim-fit with additional elastic component for even greater freedom of movement • Flex waistband • ventilation zones with stretch insert at the back of thighs • two back and thigh pockets each reinforced with CORDURA® • integrated folding rule, mobile phone and tool pocket • narrow leg hems • reflex details • OEKO-TEX® Standard 100



Realworker Jacket

men

Art. no. **89466** ■ midnight blue
89467 ■ graphite
 Size S to 6XL

women

Art. no. **89474** ■ midnight blue
89653 ■ graphite

Size XS to 4XL
 Material 1. outer fabric: 95% polyester, 5% elastane, approx. 230 g/m²
 2. outer fabric: 92% polyester, 8% elastane
 3. outer fabric: 65% polyester, 35% cotton, approx. 245 g/m²



Description: • combination of robust mixed fabrics, soft-shell material and stretch inserts in the back for optimal wearing comfort • new fit with "high rise" arm construction and additional stretch for even greater freedom of movement • one breast and two side pockets for work utensils • one inner pocket on the left with hook-and-loop fastening • reflex details • OEKO-TEX® Standard 100 (art. no. 89653)



Robust and sustainable.
In all weather conditions.

The workwear is robust and, along with special weatherproof clothing, is suitable for outdoor use. Whether you are a crafts-person or a service technician, the various pockets offer space for your tools. The four-way stretch material ensures freedom of movement and is a sustainable solution with the partly recycled polyester.

Available from
January 2023



Trousers

men

- | | |
|-----------------------|-------------------------------|
| Art. no. 88766 | ■ khaki |
| 88767 | ■ white |
| 88768 | ■ anthracite |
| 88769 | ■ graphite |
| Size | 23 to 32, 42 to 66, 90 to 110 |

women

- | | |
|-----------------------|--|
| Art. no. 88840 | ■ white |
| 88841 | ■ anthracite |
| 88842 | ■ graphite |
| Size | 19 to 26, 34 to 54 |
| Material | 90% polyester (recycled), 10% elastane, approx. 265 g/m ² |

Description: • four-way stretch material • two back and thigh pockets each reinforced with CORDURA® • integrated ruler, mobile phone and tool pocket • knee reinforcement made of CORDURA® and kneepad pockets on the inside (art. 9868900) • reflex details • OEKO-TEX® Standard 100



Fleece jacket

men

- | | |
|-----------------------|--|
| Art. no. 88932 | ■ beige |
| 88933 | ■ anthracite |
| 88936 | ■ graphite |
| Size | S to 6XL |
| Material | 100% polyester, approx. 260 g/m ² |



Description: • fashionable fleece jacket with microfleece • optimal protection against wind and wet weather when combined with all-weather jacket (7321) • stand-up collar • visible front zip • two integrated side pockets • one chest pocket on the left with zip • sleeve hem with soft edging • elongated back • width-adjustable waistband • OEKO-TEX® Standard 100

women

- | | |
|-----------------------|---|
| Art. no. 88855 | ■ white |
| 88857 | ■ graphite |
| 88856 | ■ anthracite |
| Size | XS to 4XL |
| Material | 100% polyester (recycled), approx. 315 g/m ² |



Description: • fashionable fleece jacket with Sherpa fleece • stand-up collar • stretch inserts in contrasting colours • visible front zip • two integrated side pockets • elongated back • elasticated hem • OEKO-TEX® Standard 100



All-weather jacket

- | | |
|-----------------------|--------------------------------------|
| Art. no. 88741 | ■ white |
| 88743 | ■ graphite |
| 88744 | ■ anthracite |
| Size | S to 6XL |
| Material | 100% polyester, 150 g/m ² |



Description: • optimal protection against wind and wet weather when combined with fleece jacket (7329) • width-adjustable, roll-up hood • width-adjustable hem and cuffs • one chest and two side pockets with zips • one inside pocket • breathability of 7000 MVP • water column of 8000 mm • OEKO-TEX® Standard 100

Softshell jacket

- | | |
|-----------------------|--|
| Art. no. 88824 | ■ khaki |
| 88825 | ■ white |
| 88827 | ■ graphite |
| 88828 | ■ anthracite |
| Size | S to 6XL |
| Material | 100% polyester, approx. 270 g/m ² |

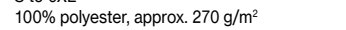

Description: • width-adjustable hood • visible front zip • one chest pocket on the left with vertical opening and concealed zip • two side pockets with zip • reflex details • OEKO-TEX® Standard 100

uvex suXXeed industry

Excellence without compromise

Comfortable to wear, sporty design, excellent materials, concealed closures, suitable for industrial laundering. We do not compromise with suXXeed industry. You don't have to either. With your own logo, different styles and colour combinations, you can customise your employees' work clothing.



Trousers

men

Art. no. 88324	■ ultramarine
88325	■ anthracite
88326	■ red
88327	■ midnight blue
88328	■ graphite
Size	23 to 32, 42 to 66, 90 to 110



Long-sleeve

men

Art. no. 88636	■ ultramarine/anthracite
88637	■ anthracite/graphite
88638	■ red/graphite
88639	■ midnight blue/anthracite
88640	■ graphite/anthracite
88641	■ light grey/anthracite
Size	S to 6XL



T-shirt

men

Art. no. 88913	■ ultramarine/anthracite
88914	■ anthracite/graphite
88921	■ red/graphite
88922	■ midnight blue/anthracite
88923	■ graphite/anthracite
88924	■ light grey/anthracite
Size	S to 6XL

women

Art. no. 88594	■ ultramarine
88595	■ anthracite
88596	■ red
88597	■ midnight blue
88598	■ graphite
Size	19 to 26, 34 to 54
Material	49% cotton, 49% polyester, 2% elastane, approx. 260 g/m ²



Description: • two-way stretch material • 3D pattern design • elasticated waistband • two back/thigh pockets • back pockets reinforced with Cordura® • double ruler pocket made of Cordura® • mobile phone/tool pocket • all zips concealed • stretch inserts on the knees • sewn-on knee-pad pockets • reflex details • slim leg hems • OEKO-TEX® Standard 100

women

Art. no. 88751	■ ultramarine/anthracite
88754	■ anthracite/graphite
88755	■ red/graphite
88756	■ midnight blue/anthracite
88757	■ graphite/anthracite
88758	■ light grey/anthracite
Size	XS to 4XL
Material	50% cotton, 50% polyester, approx. 190 g/m ²



Description: • sporty long-sleeved shirt • accentuated side seams • optimal moisture management • excellent care/washing options • OEKO-TEX® Standard 100

women

Art. no. 88906	■ ultramarine/anthracite
88907	■ anthracite/graphite
88908	■ red/graphite
88909	■ midnight blue/anthracite
88910	■ graphite/anthracite
88911	■ light grey/anthracite
Size	XS to 4XL
Material	50% cotton, 50% polyester, approx. 160 g/m ²



Description: • sporty T-shirt • tailored (women) • accentuated side seams • optimal moisture management • excellent care/washing options • OEKO-TEX® Standard 100



uvex

uvex suXXeed seamless underwear

Exceptional protection beneath the clothing

It's not just clothing for day-to-day working life that's important. What's beneath also matters on cold days. No side seams, but with functional zones that support each movement. Due to the regulating properties and different lengths, suitable for everyone, from skiers to construction workers.



Long-sleeved shirt

men

Art. no. **88301** ■ black

Size S, M/L to 5XL/6XL

women

Art. no. **88305** ■ black

Size XS/S to 3XL/4XL

Material 60% polypropylene, 28% wool, 8% polyamide, 4% elastane, approx. 250 g/m²



Description: • without irritating seams • optimal support through intelligent material combination with wool • for use at work or for leisure • quick-drying, odour-neutralizing, warming and moisture-regulating • intelligent zone concept for increased freedom of movement • OEKO-TEX® Standard 100

7/8 trousers

women

Art. no. **88306** ■ black

Size XS/S to 3XL/4XL

Material 55% polypropylene, 40% lyocell, 5% elastane, approx. 200 g/m²



Description: • with TENCEL™ without irritating seams • for use at work or for leisure • suitable for yoga • quick-drying, antibacterial and odour-neutralizing • OEKO-TEX® Standard 100

Long trousers

men

Art. no. **88302** ■ black

Size S, M/L to 5XL/6XL

Material 60% polypropylene, 28% wool, 8% polyamide, 4% elastane, approx. 250 g/m²



Description: • for use at work or for leisure • without irritating seams • material mix with wool • quick-drying, odour-neutralizing, warming and moisture-regulating • intelligent zone concept for increased freedom of movement • OEKO-TEX® Standard 100



First colourfully mixed, then washed clean.

If you're looking for an all-rounder, you've found it. Whether for gardening and landscaping, building management or wood processing, there is something for everyone. The durable trousers and tops of the uvex perfeXXion collection are for those looking for sturdy clothing in the usual high quality. Best of all: All individual pieces can be combined with each other and are suitable for washing.



EN 14404



in conjunction with kneepads (art. no. 9868900)

Type 2 - Level 1

Bermuda premium

- Art. no. **17200** ■ cocoa
17201 ■ pine
17202 ■ slate

Size 42 to 66

Material See premium trousers

Description: • very robust material due to durable yarns and special fabric structure • two multifunctional back and thigh pockets incl. folding rule, mobile phone and tool pockets as well as pen pockets and hammer loop • two back pockets • retained elastic in the rear waistband • OEKO-TEX® Standard 100



Premium trousers

With knee pockets

- Art. no. **17191** ■ cocoa
17192 ■ pine
17193 ■ slate

Size 23 to 32, 42 to 66, 90 to 110

Material 65% polyester, 35% cotton, approx. 290 g/m²



Description: See also Bermuda premium • concealed stretch insert at the knee and patch knee pockets made of CORDURA® • knee pad (art. 9868900) • reflex details • OEKO-TEX® Standard 100

Basic trousers

- Art. no. **17194** ■ cocoa
17195 ■ pine
17196 ■ slate

Size 23 to 32, 42 to 66, 90 to 110

Material See premium trousers

Description: • very robust material due to durable yarns and special fabric structure • two patch side pockets incl. folding rule, mobile phone and tool pocket as well as pen pockets • two back pockets • retained elastic in the rear waistband • OEKO-TEX® Standard 100



Basic hybrid jacket

- Art. no. **17222** ■ cocoa
17223 ■ pine
17224 ■ slate

Size XS to 6XL

Material 1st outer fabric: 65% polyester, 35% cotton, approx. 275 g/m²
 2. outer fabric: 100% polyester, approx. 310 g/m²



Description: • smart material combination with areas made of fleece • one breast pocket on the left with vertical opening and concealed zip • two side pockets • reflex details • OEKO-TEX® Standard 100





Perfect unity through a variety of possibilities

We have redefined perfection with the uvex perfect collection. Large assortment, many colours, different materials – and everything fits together. The diverse styles can be perfectly combined to create visual affiliation within a team. Alternatively, the designs can also be selected individually. Mix & match instead of boring uniform grey.



Bermuda

Art. no. 98841 ■ cornflower blue
98842 ■ anthracite

Size 42 to 64

Material 65% polyester, 35% cotton, approx. 250 g/m²

INDUSTRIALWASH●●

Description: • side pockets, two back pockets and thigh pockets with locking option • mobile phone, pen and folding rule pocket • detailing with reflective piping • five belt loops • button-adjustable elastic in the waistband • OEKO-TEX® Standard 100



Trousers

Art. no. 98837 ■ cornflower blue
98838 ■ navy
89243 ■ anthracite

Size 42 to 64, 90 to 110

Material 65% polyester, 35% cotton, approx. 250 g/m²

INDUSTRIALWASH●●

Art. no. 98833 ■ cornflower blue
98836 ■ green
98834 ■ grey
98835 ■ red
89959 ■ anthracite

Size 42 to 64, 90 to 110

Material 65% cotton, 35% polyester, approx. 310 g/m²

INDUSTRIALWASH●●

Description: • adjustable elastic in the waistband • side, double folding rule, back and thigh pocket with locking option • stretch zones on the outside of the knees for greater freedom of movement • OEKO-TEX® Standard 100



Waist jacket

Art. no. 16269 ■ cornflower blue
16270 ■ green
16271 ■ grey
16272 ■ red
89957 ■ anthracite

Size 40/42 to 64/66, 90/94 to 106/110

Material 65% cotton, 35% polyester, approx. 310 g/m²

INDUSTRIALWASH●●

Art. no. 16273 ■ cornflower blue
16274 ■ navy
89219 ■ anthracite

Size 40/42 to 64/66, 90/94 to 106/110

Material 65% cotton, 35% polyester, approx. 250 g/m²

INDUSTRIALWASH●●

Description: • Front closure with concealed metal pushers • two breast pockets with pen pocket and an inner breast pocket with closure • two side pockets with angled opening • stretch zones on shoulders for greater freedom of movement • adjustable hem and arm closure • OEKO-TEX® Standard 100

uvex suXXeed arc

uvex suXXeed multifunction

For those working on live components

The suXXeed arc and suXXeed multifunction collections are based on the highest safety standards for heavy duty and dangerous work. In addition to protection against heat and flames, they offer extended protection against arcing. This makes the collections ideal for working on electrically charged components with perfect fitting when performing any movement thanks to 3D cutting guide.

- EN ISO 11611 Class 1-A1
- EN ISO 11612 A1, B1, C1, F1
- IEC 61482-2 APC=1 APC=2 (front and sleeve only)
- EN 1149-5

IEC 61482-2 APC 2 (7 ka)
IEC 61482-2 APC 2 in the double-layered areas of the jacket and trousers (front and sleeves)

IEC 61482-1-1 ATPV in the double-layered areas of the jacket and trousers (front and sleeves) = 46 cal/cm²
in the double-layered areas of the jacket (front and sleeves) in combination with shirt 7937 = 62 cal/cm²
in the double-layered areas of the jacket (front and sleeves) in combination with shirt 7421 = 57 cal/cm²

Successful test with increased arc energy of (558.7-564.8) kJ for double-layered jacket with shirt model 7937 in accordance with EN 61482-1-2 at 11.78 kA/0.5 s (tested at Eurotest)



- EN ISO 11611 Class 1-A1
- EN ISO 11612 A1, B1, C1, E2, F1
- IEC 61482-2 APC=1
- EN 1149-5
- EN 13034 Type 6



Jacket

uvex suXXeed arc

Art. no. 88492 ■ graphite

Size S to 6XL
Material outer fabric: 50% cotton, 49% polyester, 1% antistatic fibre, 345 g/m²
lining: 88% cotton, 12% polyamide, 200 g/m²
INDUSTRIALWASH ●●

Description: • multifunctional and for the highest protection requirements • ergonomic cutting guide • double-layer construction in the front area and sleeves • integrated stretch zones for greater freedom of movement under the arms and in the back • "high-rise" sleeve construction • flame-retardant reflex strips • orange coloured pictograms for quick differentiation of protection classes • maximum protection in combination with long-sleeved shirt or poloshirt (89312, 89409, 89798)

Trousers

uvex suXXeed arc

Art. no. 88493 ■ graphite

Size 42 to 66, 90 to 110, 23 to 32
Material see jacket

Description: • for maximum protection requirements in hazardous environments • particularly soft and skin-friendly wearing comfort • double-layer construction in the front area • crotch insert for maximum freedom of movement • two leg and side pockets • with inner knee pockets • flame-retardant reflex strips • orange coloured pictograms for differentiation

Dungarees

uvex suXXeed arc

Art. no. 88494 ■ graphite

Size 42 to 66, 90 to 110, 23 to 32
Material see jacket

Description: • maximum protection when working in extreme conditions • particularly soft and skin-friendly wearing comfort • double-layer construction in the front area • integrated stretch zones on the sides for greater freedom of movement • flame-retardant reflex strips • orange coloured pictograms for differentiation

Jacket

uvex suXXeed multifunction

Art. no. 88281 ■ midnight blue
88282 ■ graphite

Size S to 6XL
Material 49% modacrylic, 42% cotton, 5% aramid, 3% polyamide, 1% antistatic fibres, approx. 300 g/m²
INDUSTRIALWASH ●●

Description: • uvex suXXeed design is multifunctional and suitable for the toughest protection requirements • flame-retardant fabric and the use of para-aramid and polyester fibres ensure high durability and multifunctional protection against molten iron E2 • particularly soft and very comfortable to wear • integrated stretch fabric panels for more freedom of movement • high-rise sleeve design • flame-retardant reflective stripes

Trousers

uvex suXXeed multifunction

Art. no. 88283 ■ midnight blue
88284 ■ graphite

Size 23 to 32, 42 to 66, 90 to 110
Material see jacket

Description: • suitable for the highest protection requirements in hazardous areas, in uvex suXXeed design • inside knee pockets for knee pads • flame-retardant reflective stripes

Dungarees

uvex suXXeed multifunction

Art. no. 88285 ■ midnight blue
88286 ■ graphite

Size 23 to 32, 42 to 66, 90 to 110
Material see jacket

Description: • maximum protection when working in extreme conditions • in uvex suXXeed design • integrated stretch zones for greater freedom of movement • inside knee pockets for knee pads • flame-retardant reflective stripes



uvex

uvex protection perfect multifunction

PPE with everything you need.

Whether it's chemicals, arcing, heat, flames, metal splashes or everything at once, uvex protection perfect multifunction has all industrial dangers covered. To describe the collection as all-rounders would be an understatement – with their stretch inserts, the garments move with the body, protecting everything.



EN ISO 11611 Class 1-A1
EN 1149-5
EN ISO 11612 A1, B1, C1, E2, F1
IEC 61482-2 APC=1
EN 13034 Type 6



Jacket

Art. no. **17241** ■ cornflower blue
17242 ■ dark grey

Size 40/42 to 64/66, 90/94 to 106/110

Material 49% modacrylic, 42% cotton, 5% aramid, 3% polyamide, 1% antistatic fibres, approx. 300 g/m²



Description: • Front panel with concealed zip and rip-tape fastening • chest, napoleon and side pockets with closure • flame-retardant fabric • flame-retardant reflective strips • stretch inserts in the back shoulder area • width-adjustable sleeve hem with rip-tape fastening • thanks to high cotton content, particularly soft and skin-friendly comfort

Trousers

Art. no. **17245** ■ cornflower blue
17246 ■ dark grey

Size 42 to 64, 90 to 110

Material 49% modacrylic, 42% cotton, 5% aramid, 3% polyamide, 1% antistatic fibres, approx. 300 g/m²



Description: • Leg, back and folding rule pocket with closure option • stretch zones on the knee externally for greater freedom of movement • flame-retardant fabric • flame-retardant reflective strips • inside knee pockets for knee pads • thanks to high cotton content, particularly soft and skin-friendly comfort

Dungarees

Art. no. **17251** ■ cornflower blue
17252 ■ dark grey

Size 40/42 to 64/66, 90/94 to 106/110

Material See trousers

Description: • Bib, leg, back and folding rule pocket with closure • stretch zones on the knee externally for greater freedom of movement • flame-retardant fabric • flame-retardant reflective strips • inside knee pockets for knee pads

► **Note:** This protective clothing must always be worn as a suit in combination with jacket and trousers or dungarees.

uvex suXXeed construction

Full body sun protection for all outdoor workers

On construction sites, many hidden dangers lurk. Not just obvious injury hazards, but sunburn and skin cancer. That's why we've included UV protection in the uvex suXXeed construction collection. In addition to sun protection, the line offers a perfect fit thanks to its 3D fit and is partly made of sustainable materials.



EN ISO 20471 EN ISO 20471



Size S - M



Size L - 6XL



Polo shirt

short-sleeved

Art. no. **88279** ■ signal orange
88280 ■ signal yellow
Size S to 6XL
Material 50% polyester, 50% cotton, approx. 180 g/m²

long-sleeved

Art. no. **88277** ■ signal orange
88278 ■ signal yellow
Size S to 6XL
Material 50% polyester, 50% cotton, approx. 180 g/m²

Description: • polo collar with button panel • 50% recycled polyester • reflective strips all around • tested according to DIN EN 13758-1 with UPF 30 (classified according to AS/NZS 4399) • longsleeve from size L onwards: additionally BG Bau eligible • OEKO-TEX® Standard 100



EN ISO 20471



Trousers

Art. no. **88267** ■ signal orange
88268 ■ signal yellow
Size 23 to 32, 42 to 66, 90 to 110
Material 50% cotton, 50% polyester, approx. 270 g/m²

Description: • crotch insert for greater freedom of movement • stretch waistband with patent button • inside leg pocket • left and right side pocket with flap and press stud fastening • UV protection certified according to UV Standard 801 with UPF 80 • OEKO-TEX® Standard 100

EN ISO 20471



Waist jacket

Art. no. **88265** ■ signal orange
88266 ■ signal yellow
Size XS bis 4XL
Material 50% cotton, 50% polyester, approx. 270 g/m²

Description: • high-rise arm design • 3D cut guide • two side pockets • front centre zip • two inner pockets • reflective tape • UV protection certified according to UV standard 801 with UPF 80 • OEKO-TEX® Standard 100



uvex protection active flash

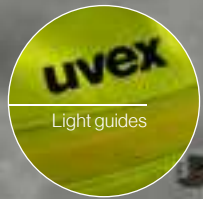

See and be seen

Reflective strips are a must in darkness and poor visibility. We've raised the bar and have installed an innovative fibre optic system that actively lights up. Thus, you can be easily seen even without an external light source. It goes without saying that the collection fits perfectly.

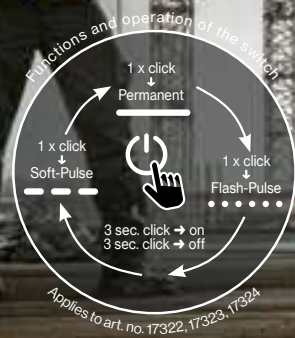

EN ISO 20471

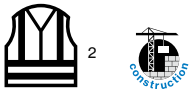

Softshell jacket

Art. no. 89910 ■ ■ signal yellow/grey
Size S to 6XL
Material 100% polyester, with three-layer membrane, approx. 240 g/m²

Description: • windproof and waterproof high-visibility softshell jacket • a Napoleon pocket on the left and two large side pockets with zip • active protection thanks to the integrated light guide system • 10,000 mm water column rating • lightweight, robust and breathable material



EN ISO 20471



Vest with switch

Art. no. 17322 ■ ■ signal yellow/signal orange
Size M to 3XL
Material 65% polyester, 35% cotton, approx. 245 g/m²

Description: • active protection thanks to horizontal and vertical light guide system • hook-and-loop fastening to quickly fasten the vest • with switch for various light modes



EN ISO 20471



Vest with switch

Art. no. 17323 ■ signal yellow
Size M to 3XL
Material 100% polyester, mesh

Description: • active protection thanks to vertical light guide system • hook-and-loop fastening to quickly fasten the vest • with switch for various light modes

Battery pack for models with switch

Art. no. 1733200 white

Description: • portable external battery for art. no. 17322, 17323 • dimensions: 93 x 58 x 12 mm, approx. 83 g





uvex cut quatreflex

Protects when work gets sharp

Glass fibre is not just good for fast internet. In the uvex cut collection, the cut-resistant fibre provides maximum protection against sharp edges, glass and are blades. Inside, the clothes are lined with bamboo yarn and are pleasantly soft. This collection is therefore robust and comfortable at the same time, even after multiple industrial cleans.

The knitted cut protection fabric protects against superficial mechanical injuries and achieves performance level D according to EN 388:2019, tested according to ISO 13977:1999.

Available from
October 2022



Trousers with functional fabric

Art. no. **17865** ■ black

Size 23 to 32, 42 to 64, 90 to 110

Material 1st material: 65% polyethylene, 35% polyester
2nd material: 65% polyester, 35% cotton, approx. 245 g/m²



Description: • high content of cut-protection fabric on the front leg and calf for optimal protection against superficial, mechanical injuries • achieves cut level C • sporty fit • two slant pockets • two back pockets • one ruler pocket including pen pocket on the left thigh • concealed waist button

uvex cut quatreflex trousers

Art. no. **17270** ■ black/anthracite (front side of trouser legs)

Size 42 to 64, 90 to 110

Material 1st material: 65% polyester, 35% cotton, approx. 245 g/m²
2nd material: 42% polyamide, 22% polyethylene, 22% viscose, 12% fibreglass, 2% elastane



Description: • casual cut • functional, highly elastic strip in the knee area • integrated inserts to allow crosswise stretch along the side seam • waistband elasticated at the back • two back pockets • protection and wearer comfort guaranteed even after repeated washing • cut protection material: extremely durable on the outside, pleasantly cool on the inside



uvex cut quatreflex t-shirt

Art. no. **17268** ■ black/anthracite (sleeves)

Size S to 3XL

Material 1st material: 50% cotton, 50% polyester, approx. 160 g/m²
2nd material: 42% polyamide, 22% polyethylene, 22% viscose, 12% fibreglass, 2% elastane



Description: • slim fit made from single-jersey fabric with cut-protection sleeves of the highest cut protection class • functional, highly elastic strip in the elbow area • integrated cuffs on sleeves without irritating seams • protection and wearer comfort guaranteed even after repeated washing • cut protection material: extremely durable on the outside, pleasantly cool on the inside



uvex cut quatreflex polo shirt

Art. no. **17266** ■ black/anthracite (sleeves)

Size S to 3XL

Material 1st material: 55% cotton, 45% polyester, approx. 185 g/m²
2nd material: 42% polyamide, 22% polyethylene, 22% viscose, 12% fibreglass, 2% elastane



Description: see below

Art. no. **17267** ■ black/anthracite (sleeves)

Size S to 3XL

Material 1st material: 54% modacrylic, 44% cotton, 2% antistatic fibres, approx. 195 g/m²
2nd material: 42% polyamide, 22% polyethylene, 22% viscose, 12% fibreglass, 2% elastane



Description: • slim fit • sleeves made from cut-resistant material of the highest cut protection class combined with heat-resistant body material made from breathable functional fibres • panel with three buttons • functional, highly elastic strip in the elbow area • integrated cuffs on sleeves without irritating seams • protection and wearer comfort guaranteed even after repeated washing • cut protection material: extremely durable on the outside, pleasantly cool on the inside



uvex suXXeed ESD

Exceptional protection for man and machine

The uvex suXXeed ESD collection prevents electrostatic discharge of the wearer or wearer to a machine. This protects sensitive electronic components. With the usual 3D fit and high-rise arm construction, perfect fitting is always ensured, both in women's and men's versions. By the way, ESD means electrostatic discharge.



Seamless shirt

men

Art. no. **88264** ■ black

Size XS/S to 3XL/4XL

women

Art. no. **88264** ■ black

Size XS, S/M to XXL/3XL, 4XL

Material 91% polypropylene, 7% polyamide, 2% silver

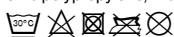

Description: • ESD suitable with antistatic fibres • quick-drying, antibacterial, odour-neutralising using innovative Dryarn® fibre • seamless processing for full well-being • OEKO-TEX® Standard 100



Trousers

Art. no. **88263** ■ Graphite

Size 23 to 32, 42 to 66, 90 to 110

Material 66.5% polyester, 32% cotton, 1.5% anti-static fibres, approx. 245 g/m²



Description: • maximum protection with antistatic fibres for optimal charge reduction and conductivity • crotch insert for greater freedom of movement • stretch waistband with patent button • left side pocket with flap and press stud fastening • OEKO-TEX® Standard 100



Coat

Art. no. **88260** □ white

88261 ■ Graphite

Size S to 6XL

Material 66.5% polyester, 32% cotton, 1.5% anti-static fibres, approx. 245 g/m²



Description: • with anti-static fibres for optimal charge reduction and conductivity • ergonomic 3D cutting guide • "high rise" arm design • breast pocket on the left, two side pockets • stand-up collar • OEKO-TEX® Standard 100

OEKO-TEX® Standard 100 Certificates



Textiles tested in accordance with the criteria of OEKO-TEX® Standard 100 ensure that no amount of substances are present that affect human health. Only products that meet the very strict requirements and undergo ongoing checks are awarded OEKO-TEX® certification. Products are shown below.



S20-0516 HOHENSTEIN HTTI

applicable to the following items:

16269, 16270, 16271, 16272, 89957, 16273, 16274, 17191, 17192, 17193, 17193, 17193, 17194, 17195, 17196, 17222, 17223, 17224, 17200, 17201, 17202, 88260, 88261, 88263, 88264, 88264, 88265, 88266, 88267, 88268, 88277, 88278, 88279, 88280, 88287, 88288, 88301, 88302, 88305, 88306, 88360, 88361, 88324, 88325, 88326, 88327, 88328, 88594, 88595, 88596, 88597, 88598, 88636, 88637, 88638, 88639, 88640, 88641, 88741, 88743, 88744, 88751, 88754, 88755, 88756, 88757, 88758, 88766, 88767, 88768, 88769, 88824, 88825, 88827, 88828, 88840, 88841, 88842, 88855, 88856, 88857, 88906, 88907, 88908, 88909, 88910, 88911, 88913, 88914, 88921, 88922, 88923, 88924, 88932, 88933, 88936, 89219, 89243, 89653, 89659, 89665, 89668, 89669, 89686, 89688, 89959, 98833, 98834, 98835, 98836, 98837, 98838, 98841, 98842



Benefit from our knowledge

The uvex academy provides qualified education and training in the fields of personal protective equipment (PPE) and health and safety at work.

All uvex academy training sessions are offered in-house or as company seminars. Seminars in accordance with your individual specifications can be developed on request.

- Laser protection
- Protective eyewear (more information on page 61)
- Prescription safety spectacles/goggles (more information on page 414)
- Hearing protection
- Hand protection
- Protective footwear (more information on page 342)
- Internships



The uvex academy is
your competent partner
for qualified training and further education.

You can find more information
at uvex-academy.com



uvex



EUROPA

UVEX ARBEITSSCHUTZ GMBH

Würzburger Straße 181-189
90766 Fürth
GERMANY

T: +49 911 9736 360
F: +49 911 9736 460
E: serviceteam@uvex.de
I: uvex-safety.de

UVEX SAFETY Textiles GmbH

Robert-Schumann-Straße 33
08236 Ellefeld
GERMANY

T: +49 3745 740-0
F: +49 3745 740-100
E: corporatefashion@uvex.de
I: uvex-safety.de

UVEX SAFETY Gloves GmbH & Co. KG

Elso-Klöver-Straße 6
21337 Lüneburg
Postfach 24 47 · 21314 Lüneburg
GERMANY

T: +49 4131 9502-0
F: +49 4131 84338
E: gloves@uvex.de
I: uvex-safety.de

UVEX SAFETY Austria GmbH

Kamerlweg 33
4600 Wels
AUSTRIA

T: +43 7242 210 745
F: +43 7242 210 745-28
E: safety@uvex.at
I: uvex-safety.at

UVEX Arbeitsschutz (Schweiz) AG

Uferstrasse 90 - Postfach
4019 Basel
SWITZERLAND

T: +41 61 638 84 44
E: info@uvex.ch
I: uvex-safety.ch
I: heckel-safety.ch

UVEX HECKEL s.a.s.

44 rue d'Engwiller
La Walck
67350 Val de Moder
FRANCE

T: +33 3 88 07 61 08
F: +33 3 88 72 51 06
E: contact.france@uvex-heckel.fr
I: uvex-heckel.fr

UVEX SAFETY (UK) LTD

uvex House
Farnham Trading Estate
Farnham
Surrey
GU9 9NW
UNITED KINGDOM

T: +44 1252 73 12 00
E: safety@uvex.co.uk
I: uvex-safety.co.uk

UVEX Safety Italia S.R.L.

Corso Grosseto 437
10151 Torino
ITALY

T: +39 011 4536511
F: +39 011 7399522
E: info@uvex-safety.it
I: uvex-safety.it

SwedSafe AB

Nordanväg 7
28235 Tyringe
SWEDEN

T: +46 451 25 34 00
M: +46 768 40 15 03
I: uvex-safety.se

UVEX SPR OOO

Blagodatnaya str. 67
196105 St. Petersburg
RUSSIA

T: +7 812 327 6781 and
8 800 500 78 90
F: +7 812 327 6781
E: uvex@uvex-safety.ru
I: uvex-safety.ru

UVEX SAFETY Polska sp. z o.o. sp.k.

Większyce, ul. Głogowska 3A
47-208 Reńska Wieś
POLAND

T: +48 77 482 62 58
F: +48 77 482 62 57
E: uvex@uvex-integra.pl
I: uvex-safety.pl

UVEX Safety CZ, k.s.

Na Jamách 394
516 01 Rychnov nad Kněžnou
CZECH REPUBLIC

T: +420 494 531 331
F: +420 494 533 395
E: info@uvex.cz
I: uvex-safety.cz

UVEX Safety SK k.s.

Jesenná 1
080 05 Prešov
SLOVAKIA

T: +421 517 732 138
M: +421 918 964 591
E: uvex@uvex-safety.sk
I: uvex-safety.sk

UVEX Safety Hungaria Bt.

Terstyánszky u. 23.
2083 Solymár
HUNGARY

T: +36 26 560093
M: +36 30 4773135
F: +36 26 560092
E: e.boros@uvex.de
I: uvex-safety.hu

ASIA · PACIFIC · AUSTRALIA

UVEX (GUANGZHOU) SAFETY CO. LTD

No. 3, Building ShenLan Industrial Zone
ShiBei Avenue Dashi Panyu
Guangzhou Guangdong
CHINA 511430

T: +86 20 3479 2338
F: +86 20 3479 1098
E: info@uvex.com.cn
I: uvex.com.cn

UVEX SAFETY SINGAPORE PTE LTD

25 International Business Park Rd,
#03-112/113, German Centre
SINGAPORE 609916

T: +65 6162 8138
E: sales@uvexsafety.com.sg
I: uvex-safety.com.sg

For Indonesia:

UVEX SAFETY SINGAPORE PTE LTD

Representative Office Indonesia
Pondok Indah Office Tower 3, 17th Floor
Jl. Sultan Iskandar Muda, Kav. V-TA
Pondok Indah, Jakarta 12310
INDONESIA

T: +6221 2953 8910
E: sales@uvex-safety.com.sg
I: uvex-safety.co.id/id

For Malaysia:

UVEX SAFETY SINGAPORE PTE LTD

Representative Office Malaysia
Regional Office Malaysia
1 Sentral, Level 16,
Jalan Stesen Sentral 5,
KL Sentral, Kuala Lumpur 50470
MALAYSIA

T: +603 2092 9261
E: sales@uvex-safety.com.sg
I: uvex-safety.com.my

UVEX SAFETY AUSTRALIA LIMITED PARTNERSHIP

Unit 3 Riverside Centre
24-28 River Road West
Parramatta NSW 2150
AUSTRALIA

T: +61 2 9891 1700
F: +61 2 9891 1788
E: info@uvex.com.au
I: uvex-safety.com.au

Sydney 1800 815 790
Melbourne +61 3 9832 0851
Brisbane +61 7 3394 8414
Adelaide +61 8 8376 0732
Perth +61 8 9209 1444

UVEX Safety New Zealand Pty Ltd

T: +64 800 698 839
E: info@uvex.co.nz
I: uvex-safety.co.nz

AFRICA · MIDDLE EAST AND INDIA

uvex safety South Africa (Pty) Ltd

2 Kubu Avenue,
Riverhorse Valley,
Effingham, Durban, 4051
SOUTH AFRICA

T: +27 31 569 67 80
E: info@uvex.co.za
I: uvex.co.za

UVEX ARBEITSSCHUTZ GMBH

Dubai Office
B6-606
HQ Building
Dubai Silicon Oasis
Dubai
UAE

Middle East & India:
T: +971 4 372 4753
E: sales@uvex.co.za
I: uvex-safety.com

uvex Safety Eyewear			17
Coating technology	22	Welding protection	69
Labelling and norms	25	Accessories	71
Lens tinting	26	Cord/case mix	74
Safety spectacles	31	Applications	75
Overspecs	56	Safety eyewear – Overview	76
Safety goggles	59		

uvex Hearing Protection			79
All ears when it comes to safety	82	Banded ear protection	96
Size and fit	84	uvex earmuff range	99
Disposable hearing protection plugs	88	uvex pheos helmet system	105
Reusable ear plugs	92	Accessories	108
Detectable	94	Hearing protection – Overview	110

uvex Safety Helmets			111
Standards at a glance	112	Visors and face protection	136
Safety helmets	115	Face protection system	137
Accessories	129	Accessories – combination options	138
Head torchs	132	Impact caps	147
Visor lenses, certification and norms	134	Safety helmets – Overview	149

uvex Breathing Protection			151
Respirator advisor	152	Respirators uvex silv-Air c	162
The uvex breathing protection navigator	153	Respirators uvex silv-Air 9517	166
Applications	154	Medical face mask	167
Combination options with uvex safety eyewear	155	Pictograms – Functions	168
Respirators uvex silv-Air premium	156	Breathing protection – Overview	169
Respirators uvex silv-Air e	159		

uvex Disposable Coveralls			171
Guide to standards and products	172	Accessories	181
Disposable coverall type 3B	174	Protection against infectious diseases	182
Disposable coverall type 4B	177	Chemicals database	183
Disposable coveralls type Typ 5/6	178	Guidelines for use	184

uvex Safety Gloves			185
Standards	194	Chemical risks	232
in the food industry	194	Disposable safety gloves	241
Mechanical risks	200	HexArmor safety gloves	246
uvex Chemical Expert System	230	Safety gloves – Overview	256

uvex Safety Footwear			257
Areas of application	262	Safety footwear	272
uvex multiple width system	263	Accessories: inlay soles	336
Pictogram overview	264	uvex care system	338
Technologies	265	Polymer boots	339
Standards and labels, ESD	267	Safety footwear – Overview	340

uvex Individual PPE			343
Prescription safety eyewear	352	IndividueTailor-made hearing protection uvex high-fit	394
VDU spectacles	386	Orthopedic foot protection uvex medicare	409

uvex Workwear			415
uvex suXXeed greencycle planet collection	418	uvex suXXeed multifunction collection	427
uvex collection 26	419	uvex protection perfect multifunction collection	428
uvex suXXeed collection	421	uvex suXXeed construction collection	429
uvex suXXeed craft	422	uvex protection active flash collection	430
uvex suXXeed industry	423	uvex cut collection	431
uvex suXXeed seamless underwear collection	424	uvex suXXeed ESD collection	432
uvex perfeXXion collection	425		
uvex perfect collection	426		
uvex suXXeed arc collection	427		



Thank you for your interest in our online catalogue! By not using a printed paper version, we were able to save valuable resources. uvex protecting people - and the environment.

Resources saved:



Wood
87.178 kg



Water
906.456 l



Energy
325.202 kWh



CO₂ emissions
44.350 kg

UVEX ARBEITSSCHUTZ GMBH
Wuerzburger Straße 181-189
90766 Fuerth
GERMANY

T: +49 911 9736-0
F: +49 911 9736-1760
E: safety@uvex.de
I: uvex-safety.com